



河北东联金属网栏有限公司
HEBEI **DONGLIAN**
METAL WIRE MESH FENCE CO., LTD.

2023 版

河北东联金属网栏有限公司

HEBEI DONGLIAN METAL WIRE MESH FENCE CO., LTD.

地址：河北省衡水市安平县保衡路刘吉口村西 500 米处

Add: 500 Meters West, Liujikou Village, Baoheng Road,

Anping County, Hengshui City, Hebei Province.

电话 (Tel): 0318-7717777

传真 (Fax): 0318-7823999

手机 (Mob): 13903287777 13903286666

18831806666 18832806666

网址 (Web): www.jiaotonghulan.com

邮箱 (E-mail): 987717888@qq.com

东 联 网 栏



公司简介

Company Introduction

河北东联金属网栏有限公司位于中国著名的“丝网之乡”河北安平。公司注册资金2018万元，占地面积100亩，是一家专业生产高速公路护栏网，公路隔离栅，铁路防护栅栏，监狱钢网墙，交通护栏（京式护栏），机场护栏网，移动护栏网，厂矿围栏网，花园别墅护栏网，体育场围栏网，刺网防护栏，边坡防护网，勾花网护栏，金属浸塑网片，盘扣式脚手架，声屏障，爬架网，安全标准化，钢格板，钢板冲拉网等丝网防护产品的厂家，产品广泛应用在高速公路、铁路、机场、码头、港口、体育场、监狱、市政建设、工厂、小区、园林等的隔离与防护。曾多次在国内大型高速公路隔离栅与铁路防护栅栏的招标活动中中标，并以高质量的产品与服务满足了招标施工单位的要求，获得极大好评！

我公司生产的防护产品具有抗老化，耐腐蚀，不褪色，表面光亮的优点。公司依靠先进的生产检测设备，标准化的生产方案，严格的质量管理体系。保证了产品的高质量、高品质，深得客户的信赖。

我公司奉行“高效率，高质量，高服务”的三高理念，为广大客户提供最优质的产品与服务，欢迎广大新老客户垂询订购我们的产品。

Hebei Donglian Metal Wire Mesh Fence Co., Ltd. is located in Anping County, Hebei, which is famous as the "Native land of wire mesh". Company registered capital of 20.18 million Yuan, covers an area of 100 acres, which is a professional engaged in highway Fence, road fence, rail fence protection, airport Fence, moving Fence, factories and mines fencing, garden villas Fence, stadium fence, barbed wire fence, gabion fence, Chain Link Fence, PVC-coated panel, Disc Buckle Scaffold, Acoustic Barrier, Climbing Frame Net, Safety Standardization, Steel Grating, expanded metal, etc. the products are widely used in highways, railways, airports, docks, ports, stadiums, prisons, municipal construction, factories, residential, gardens and other isolation and protection. On several occasions in the domestic large-scale highway and rail fence protection activities in the tender bid, and to high-quality products and services to meet the requirements of the tendering and construction units. This gained well known reputation.

Our Protection products produced with the anti-aging, anti-corrosive, non-fading, surface brightness advantages. Companies rely on advanced production and testing equipment, standardized production of the program, strict quality management system. Our company won the trust of customers by ensuring the high quality and excellent service.

Our company adheres to the "high efficiency, high quality, and high excellent-service" three high-concepts, to provide our clients with the highest quality products and services. We high welcome all customers both abroad and domestic to visit our company and order the super products.

企业文化

Enterprise Culture

企业宗旨：百年大计，质量第一

企业使命：以品质营筑梦想，以诚信营筑家园

企业风气：求真务实，简洁高效，团结协作

经营理念：用户至上，诚信经营

价值观：勤奋敬业，追求卓越

企业形象：一、社会中的形象：责任、贡献

二、客户中的形象：优质、信誉

三、员工中的形象：公正、求实

四、行业中的形象：规范、诚信

产品目录

Products Contents

铁路防护栅栏 Railway Fence	P01-06
铁路桥梁钢栏杆 Steel Railings For Railway Bridges	P07-08
边境围栏 Border Fence	P09-10
光缆桥架 Fiber Optic Cable Tray	P11-12
电力支架 Power Bracket	P13-14
高速公路隔离栅 Highway Fence	P15-22
声屏障 Acoustic Barrier	P23-30
交通护栏 Traffic Fence	P31-38
临时护栏 Temporary Fence	P39-40
基坑护栏 Foundation Pit	P41-42
爬架网 Climbing Frame Net	P43
安全标准化 Safety Standardization	P44
机场防护网 Airport Fence	P45-46
监狱防攀爬隔离网 High Security Prison Fence	P47-48
体育场围网 Stadium Fence	P49-50
锌钢护栏 Zine Steel Fence	P51
欧式护栏 Palisade Fence	P52
桃型柱护栏 Peach-Shaped Fencing	P53-54
石笼网(格宾网) Gabion Mesh	P55-56
边坡防护网 Defend Slope Fence	P57-58
防风抑尘网 Dust Suppression and Wind Proofing Wall	P59-60
钢格板 Steel Grating	P61-62

◎ 铁路防护栅栏

Railway Fence



※ 铁路线路防护栅栏通线（2012）8001

- ◆ 外观尺寸为1800×3000mm（立柱中心距）。
- ◆ 边框采用30×50×2.0mm的矩型管制成。
- ◆ 网片由直径为4.0mm的钢丝焊接而成。
- ◆ 网孔75×150mm。
- ◆ 小立柱采用40×40×2.5mm的方管制成。
- ◆ 大立柱采用水泥立柱120×120。
- ◆ 金属网进行镀锌后防腐浸塑处理。



DL-001

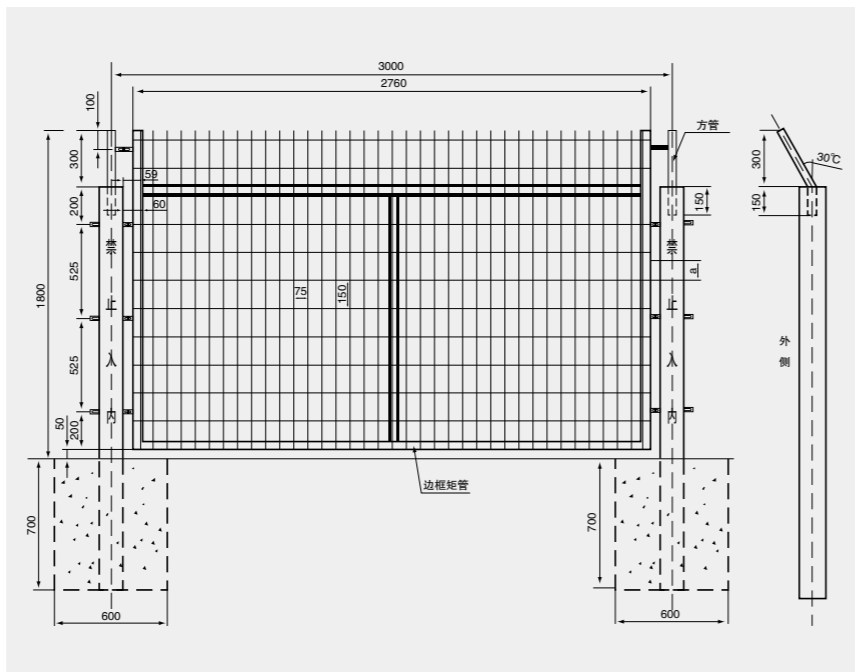

※ 高速铁路线路防护栅栏通线（2012）8002

- ◆ 外观尺寸为1700×3000mm（立柱中心距）。
- ◆ 边框采用30×50×2.0mm的矩型管制成。
- ◆ 网片由直径为4.0mm的钢丝焊接而成。
- ◆ 网孔75×150mm。
- ◆ 金属网进行镀锌后防腐浸塑处理。



DL-003

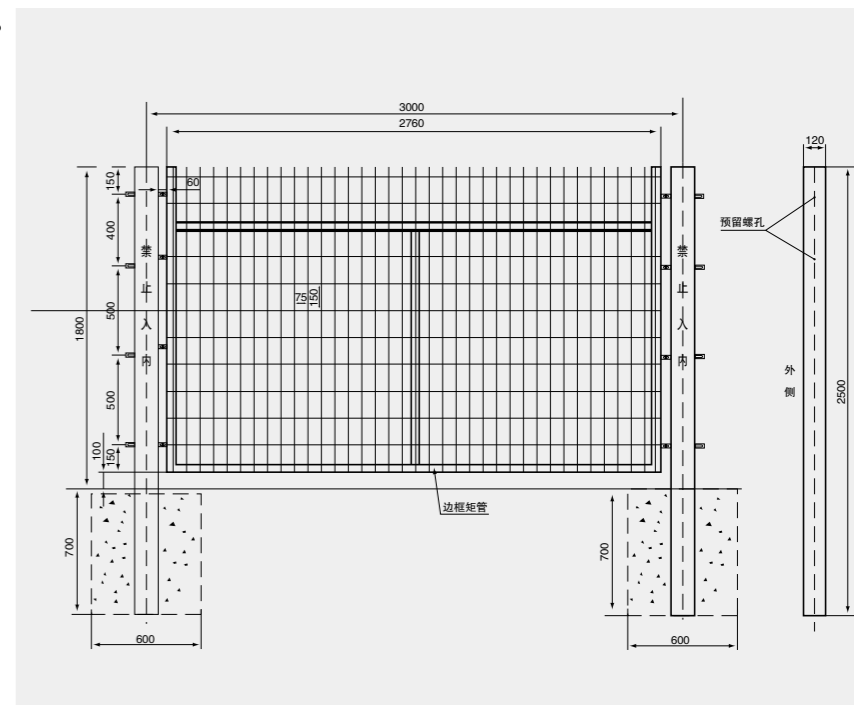

DL-002



DL-004

※上海铁路局角铁防护栅栏

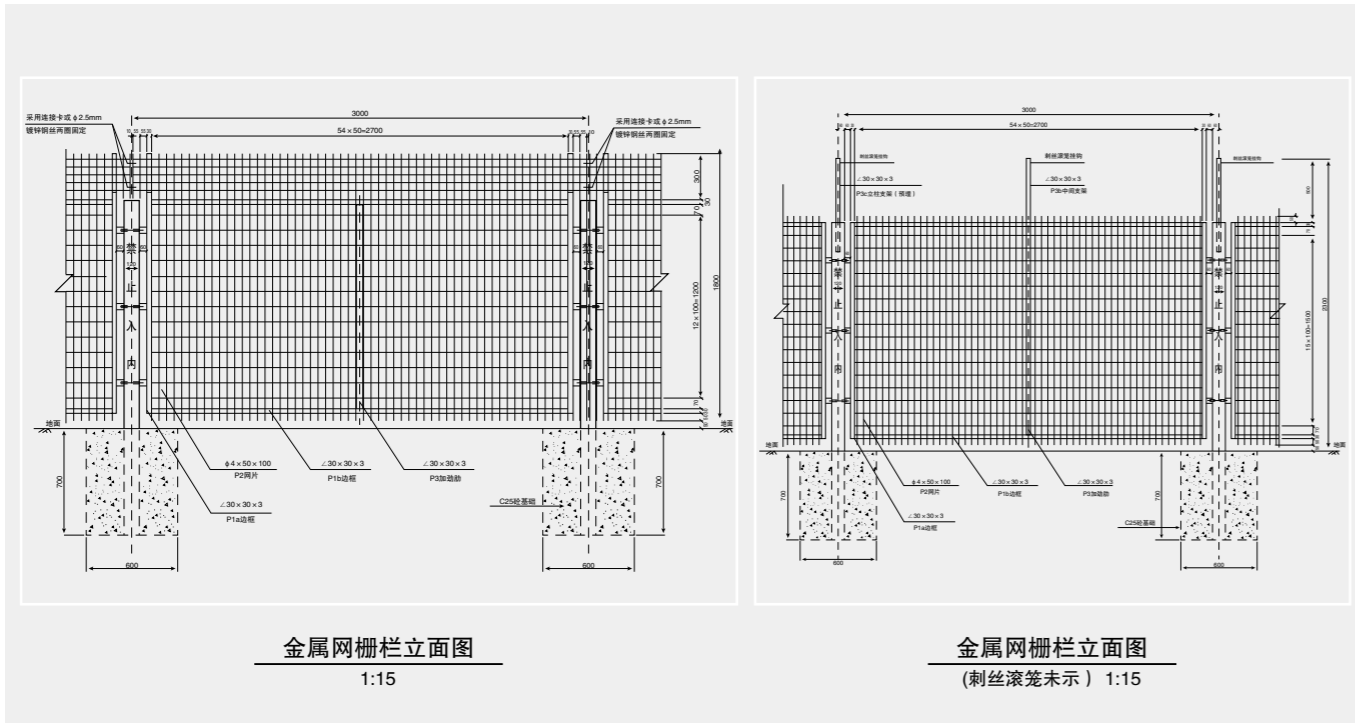

※刺丝滚笼加高网防护栅栏

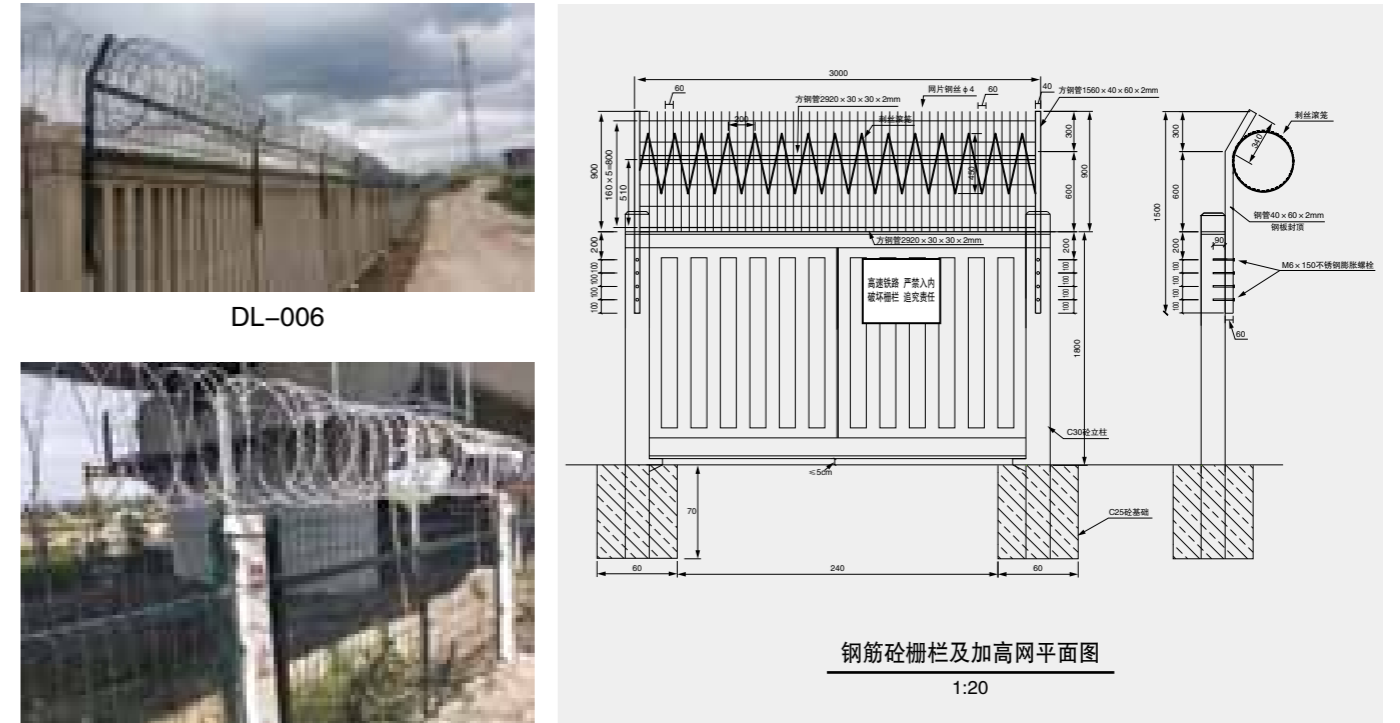

DL-005



DL-008

※高速铁路桥墩吊围栏

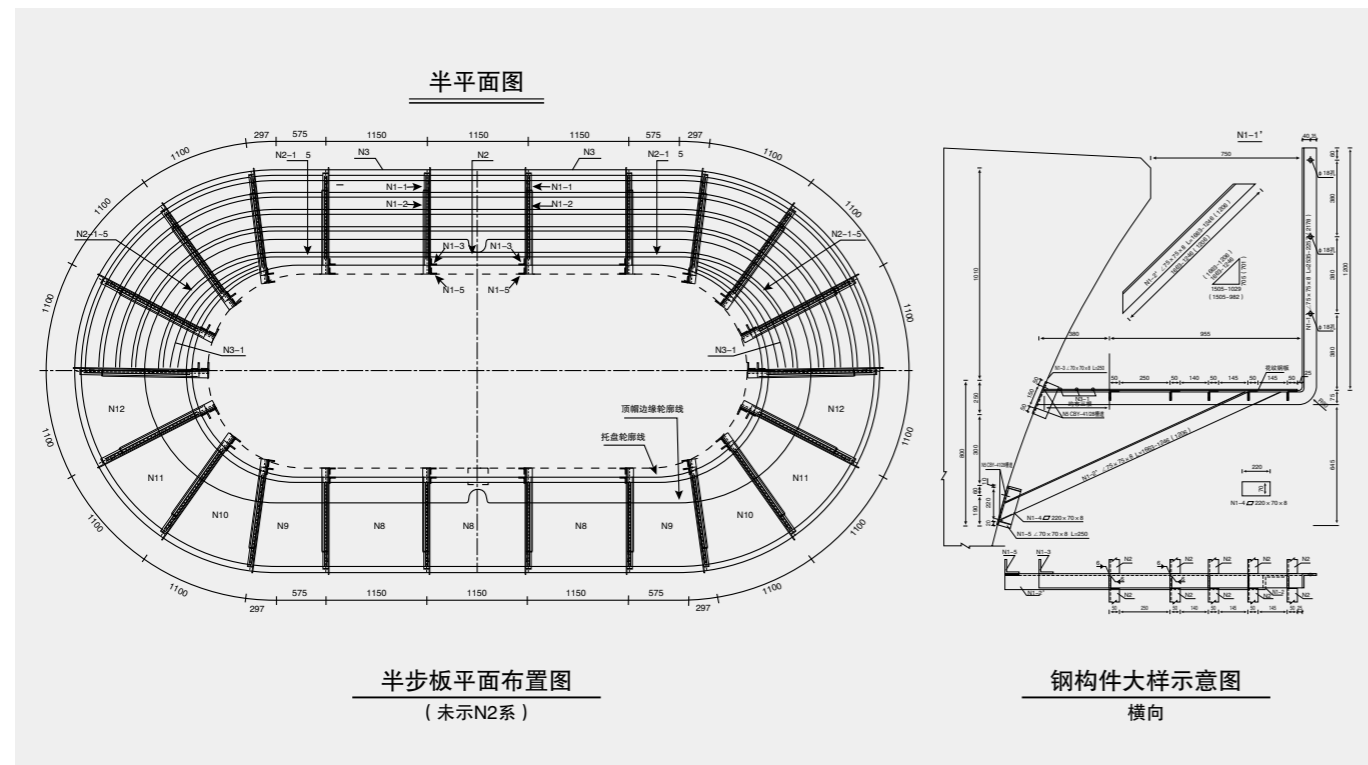

DL-010



DL-009



DL-011

◎ 铁路桥梁钢栏杆

Steel Railings For Railway Bridges

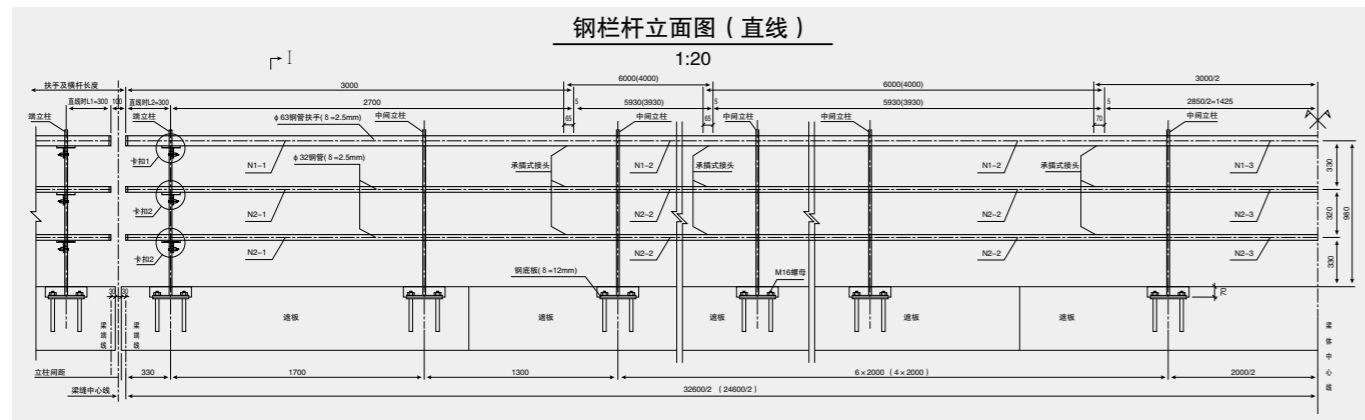

DL-012



DL-013



DL-015



DL-014



DL-016

◎ 边境围栏

Border Fence



※ 电子围栏系统



DL-017

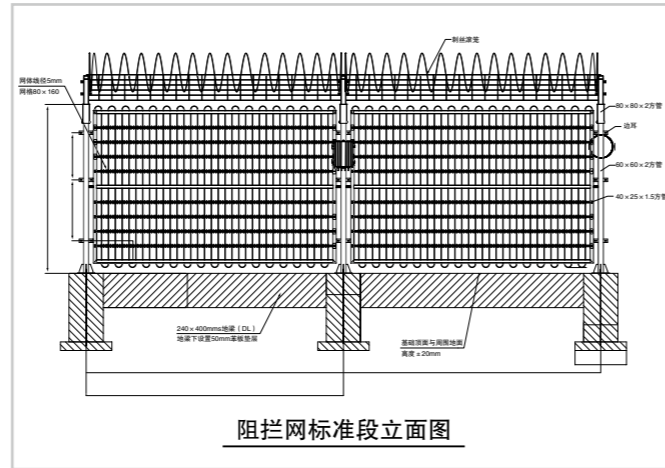

DL-018

※ 防爆阻隔网

阻隔网是为执勤和处置群体性事件配备的战术性器材，该产品由单环型和三环型两种结构，主要用于群体事件和道口及道路的封闭。该产品刀片锋利，具有威慑力，底部设有4个收缩式的脚轮，在收拢状态下能很方便的推动行走，外部配有帆布外罩，方便运输、存放、搬运装卸。

适用范围：应用于固定执勤目标和移动执勤目标，车站、重要目标、重要战略目标、重大设施场所大门、机关大门和高速公路出口等。



DL-019



DL-020



DL-021



DL-022

◎ 光缆桥架

Fiber Optic Cable Tray

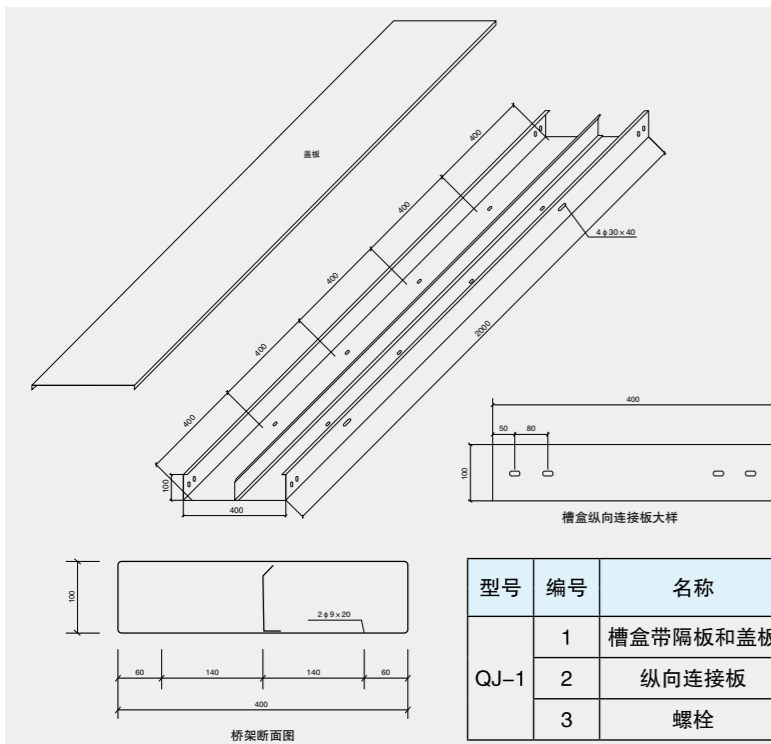

说明:

1. 桥架槽盒采用不锈钢 (304 材质) 制作, 板材厚度为 1.5mm。
2. 桥架的技术性能指标应满足左表和《电缆防火措施设计和施工验收标准》的规定。
3. 每套板材用量 2.38 平方米。
4. 桥架表面处理喷防火型, 里、外塑层厚度各 $\geq 65 \mu\text{m}$, 电缆桥架及其附件的耐火极限不应低于 30min。
5. 中间隔板采用焊接方式。
6. 桥架加工及安装应满足钢制桥架设计规范 CECS31-2010。
7. 桥架弯通需充分考虑电缆弯曲半径 (符合 JGJ16-2008 民用建筑电气设计规范表 8.7.1 电力电缆最小允许弯曲半径)。
8. 跨接接地线应采用铜芯软导线或镀锡编织线, 跨接线允许截面不小于 8 平方毫米 (铜制), 跨接接地宜采用焊接在电缆桥架本体上的专用接地螺栓作为跨接接地连接点, 整排桥架每 30 米用接地扁钢 (50×5) 与电缆沟接地主网相连。焊缝高度应不小于母材厚度, 焊缝应满焊。焊接完毕后, 清除焊渣, 并涂一层防腐漆, 两层银色油漆。
9. 所有材料数量以现场数量为准, 表中数量仅供参考。供方需现场测量后经设计单位核对供货。

材料表

型号	编号	名称	规格	单位	数量	重量 (kg)		总重
						一件	小计	
QJ-1	1	槽盒带隔板和盖板	400×100×2000	套	1	26.565	26.565	
	2	纵向连接板		套	2	0.48	0.96	
	3	螺栓	M8	套	8			

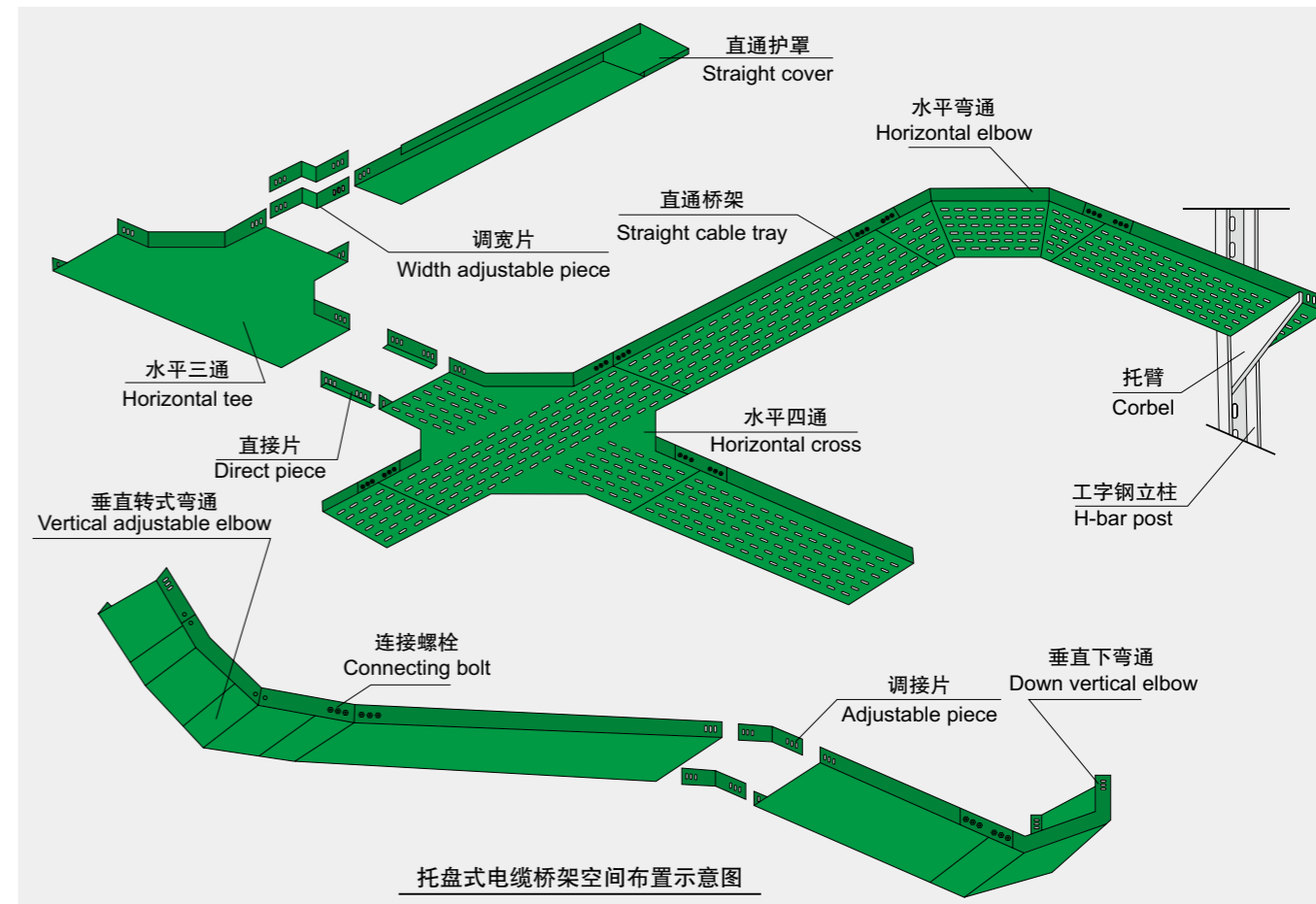

托盘式电缆桥架空间布置示意图



DL-023

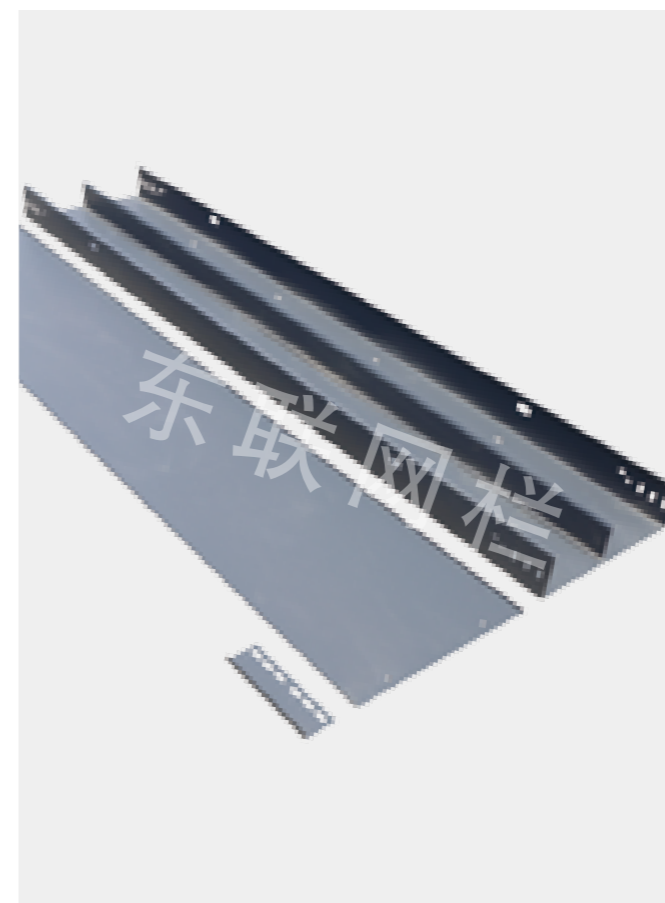

DL-024



DL-025

◎ 电力支架

Power Bracket

材料表

型号	编号	名称	规格	单位	数量	重量 (kg)		总重 (kg)
						一件	小计	
ZJ-4	1	角钢	L70×6	根	1	10.79	10.79	26.27
	2		L63×6	根	5	2.58	12.9	
	3		L63×6	根	1	2.58	2.58	

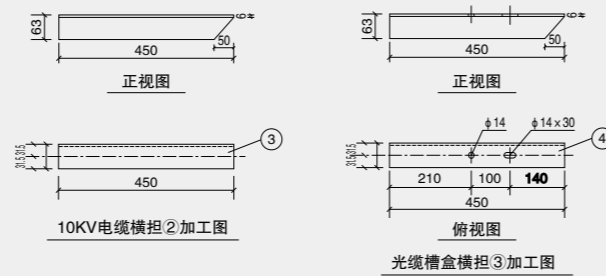
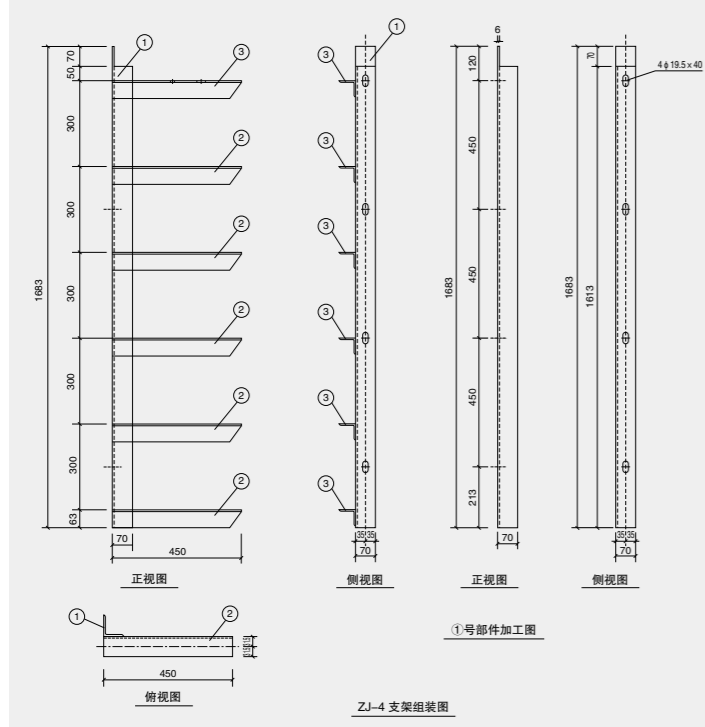

- 说明:
1. 电缆支架由角钢及钢板焊接组成, 其横担与立铁抹角, 在保证其外型几何尺寸情况下, 放样确定。
 2. 材料选用Q235钢。
 3. 焊接工艺为三面满焊, 焊缝高度应大于等于母材厚度。
 4. 电缆支架焊接后进行除锈处理, 整体镀锌后涂塑防腐, 镀锌层厚度不小于 $86 \mu\text{m}$, 涂塑层厚度不小于 0.4mm 。
 5. 支架横铁不得有飞边毛刺, 夹角需打磨圆滑。



DL-027



DL-026



DL-028

◎ 高速公路隔离栅 Highway Fence



※ 框架型护栏网 / Framed Fence

材料：低碳钢丝

编织及特点：编织焊接而成。

产品特点：防腐、防老化、抗晒、耐候等特点。

防腐形式有电镀、热镀、喷塑、浸塑。

用途：用于公路、铁路、飞机场、住宅小区、港口码头、花园、畜牧等的护栏防护。

Material: Low carbon steel wire.

Structure: Weaved or welded by low carbon steel wire. Fixed by the linking accessories and steel pipe.

Characteristics: High strength, good steel natural capacity, wonderful shape, wild field of vision, easy to install.

Uses: Be applied as protection fencing of highway, railway, airport, residential area, port, garden and farming, etc.

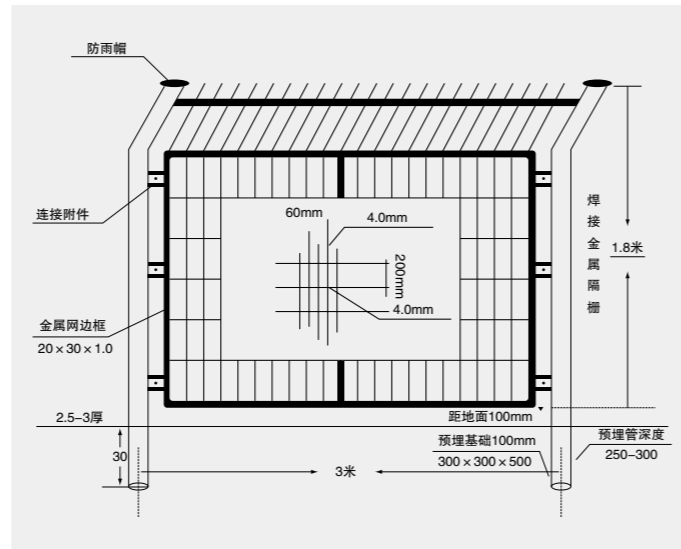

DL-029

※ 双边丝护栏网 / Fence With Double Wire Edges

本系列防护网具有结构简练、美观实用，便于运输，安装方便，对地形适应能力强等特点。

This series of protective mesh are simple in structure, beautiful in practicality, easy in transportation, convenient in installation, and suitable in topography.

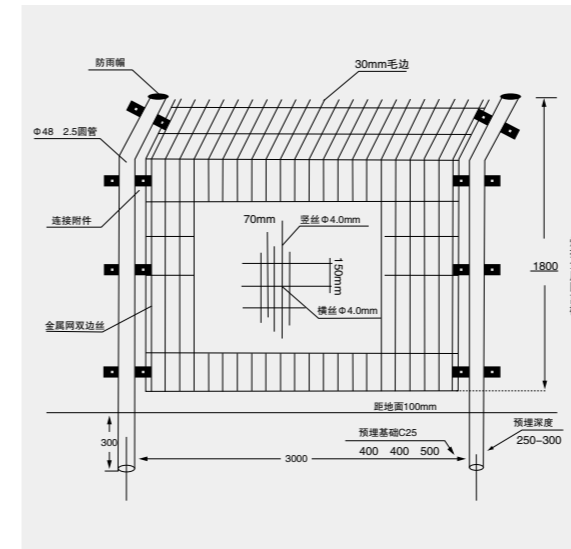

DL-030



DL-031

※防眩网护栏 / Anti-dazziness Fence

防眩网既可保证防眩设施的连续性和横向通视，又可隔离上下行车道，达到防眩和隔离的目的。防眩网经济实用，外形美观，风阻少，经过镀锌涂塑双层防腐处理，能延长使用寿命，减少维护费用，安装便利，不易损坏，接触面小，不易沾尘能长久保持整洁。

Anti-dazziness facility fence can guarantee the continuity and horizontal Intervisibility, but also isolate the upper and lower lane, for anti-glare and isolation purposes. Anti-glare fence, economical and practical, pleasing in appearance, less air resistance, after a double-coated galvanized anti-corrosion coating treatment can prolong life and reduce maintenance costs. It is also easy in installation, not easy to damage, small contact surface, dust-free and easy to keep clean.

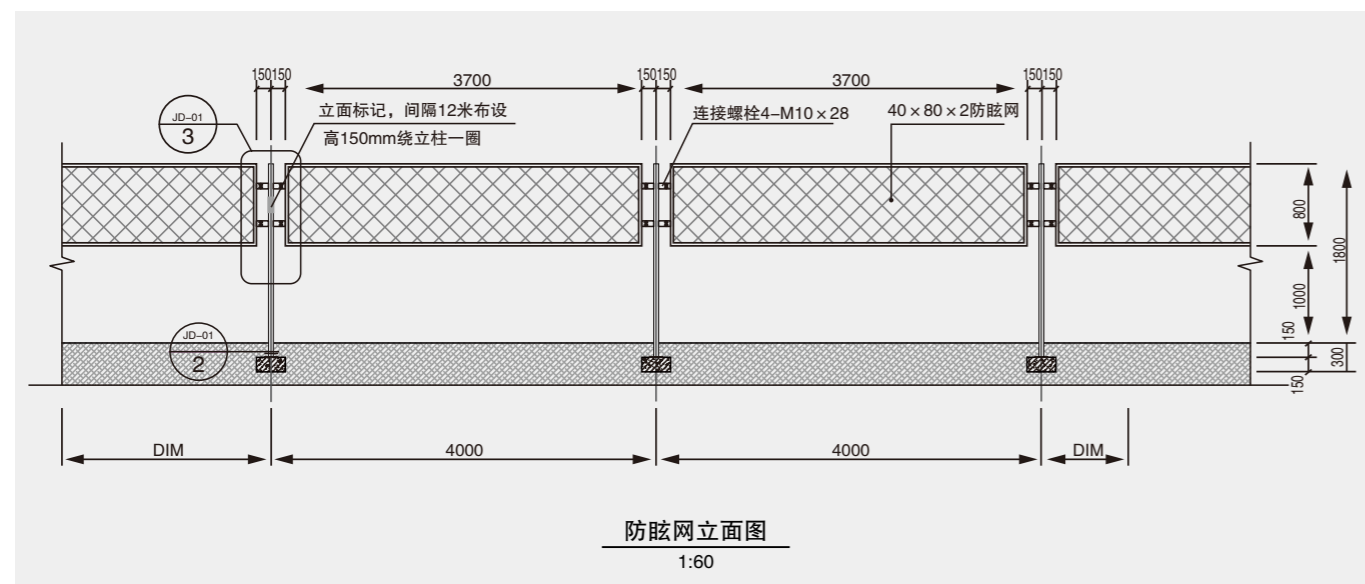

※防眩网护栏 / Anti-dazziness Fence



DL-033



DL-032



DL-034

※刺铁丝护栏 / Barbed Wire Fence

材料：优质低碳钢丝(镀锌、包塑)；有蓝、绿、黄等颜色。

编织及特点：拧编而成；牢固、美观。

用途：用于草场边界、铁路、高速公路的隔离防护等。

Material: High quality low carbon steel wire (galvanized, PVC coated); Color available in blue, green, yellow etc.

Weaving and Characteristics: Twisted and weaved; firm and beautiful.

Uses: Be used as barriers for pastures, railways, and expressways etc.

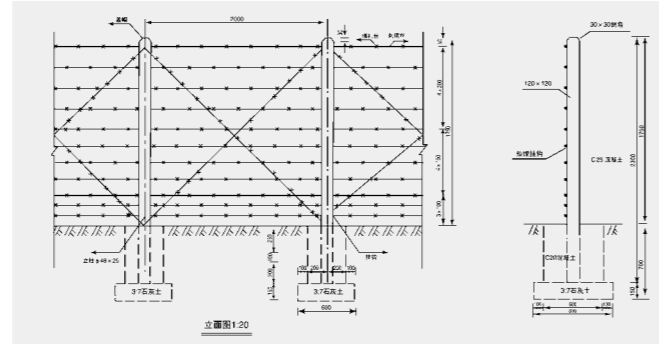

DL-035



DL-036



DL-037

※双圈护栏网 / Fence With Double Circles

结构：用冷拔低碳钢丝焊接成网筒状卷边与网面一体，用连接附件与钢管支柱固定。

特点：强度高、钢性好、造型美观、视野宽广，安装简便，感觉明亮、轻松。

Structure: The tube-like mesh edges, welded with cold-drawn low-carbon steel wire, together with net as one is fixed with joint accessories and steel poles.

Characteristics: High strength, fine steel, beautiful appearance, wide view, easy installation, bright and comfortable feeling.

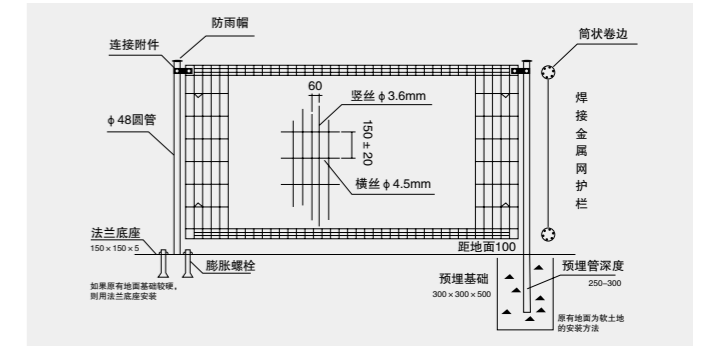

DL-038



DL-039

※C型柱护栏网 / C-shaped Fencing

C型柱护栏网采用高强度低碳钢丝焊接成网后与C型钢柱用连接螺栓成型，具有网面平、紧等特点。

C-shaped fencing is made with welded high strength low carbon wire mesh and joined with C-shaped steel pillars and joint bolts. The mesh is smooth and close.



DL-040

◎ 声屏障

Acoustic Barrier



※公路声屏障 / Highway Sound Barriers

该产品不仅具有良好的吸音隔声性能，还具有优异的耐候性和物理性能，防水、防尘，在扬尘或淋雨环境中其吸音效果不受影响。本实用新型还具有外形美观、自重轻、安装方便及便于维修等优点。因此，可广泛用于交通噪声的治理工程。

The product has such characteristics as good sound insulation properties, excellent weather resistance and physical properties, waterproof, and dustproof, i.e. it serves well in dust and rainy environment. It is light, beautiful and easy to install and maintain. Therefore, it is widely used the sound treatment in transportation and communication projects.



DL-048



DL-049



DL-051



DL-050



DL-052

※铁路声屏障 / Rail Sound Barriers

金属微穿孔吸声板在道路交通声屏障、城市轨道声屏障、高铁声屏障等声屏障工程中常用来作为吸声构件中的面层，可以根据需要噪声频率特性，定制不同穿孔率、孔径的金属微穿孔吸声板。吸音板的表面有很多小孔，声音进入小孔后，便会在结构的内壁中胡乱反射，直至大部分声波的能量都消耗了，变成热能，达到了隔音的效果。

Metal micro-perforated sound absorbing board is often used as sound absorbing elements in the surface layer of the road traffic soundproofing wallboard, urban rail soundproofing wallboard, soundproofing wallboard, and high-speed rail projects. Various metal micro-perforated sound boards of different perforation rate, aperture can be customized according to the needs of the sound frequency characteristics. In the surface of the sound absorbing board, there are many holes, into which the sound enters and are reflected in disorder in the wall structure until most of the sound energy is consumed into heat energy, hence the effect of sound insulation.



DL-053



DL-055



DL-054



DL-056

※城市景观声屏障 / Urban Landscape Sound Barriers



DL-057



DL-058



DL-060



DL-059



DL-061

※非金属声屏障 / Non-metal Sound Barriers

产品介绍：非金属吸声板是非金属声屏障重要的组成部分，主要用于消声。非金属声屏障分为整体式和插板式。

插板式主要材料有水泥穿孔板、珍珠岩、水泥木屑板、GRC等；整体式有珍珠岩、水泥木屑板等。

产品特点：整体式非金属吸声板自重大，防撞性能良好，使用年限长。

插板式非金属吸声板制作安装方便，屏体色彩丰富。

产品用途：高速铁路、轨道交通、铁路、城市高架、高速公路、工业降噪等。



DL-062

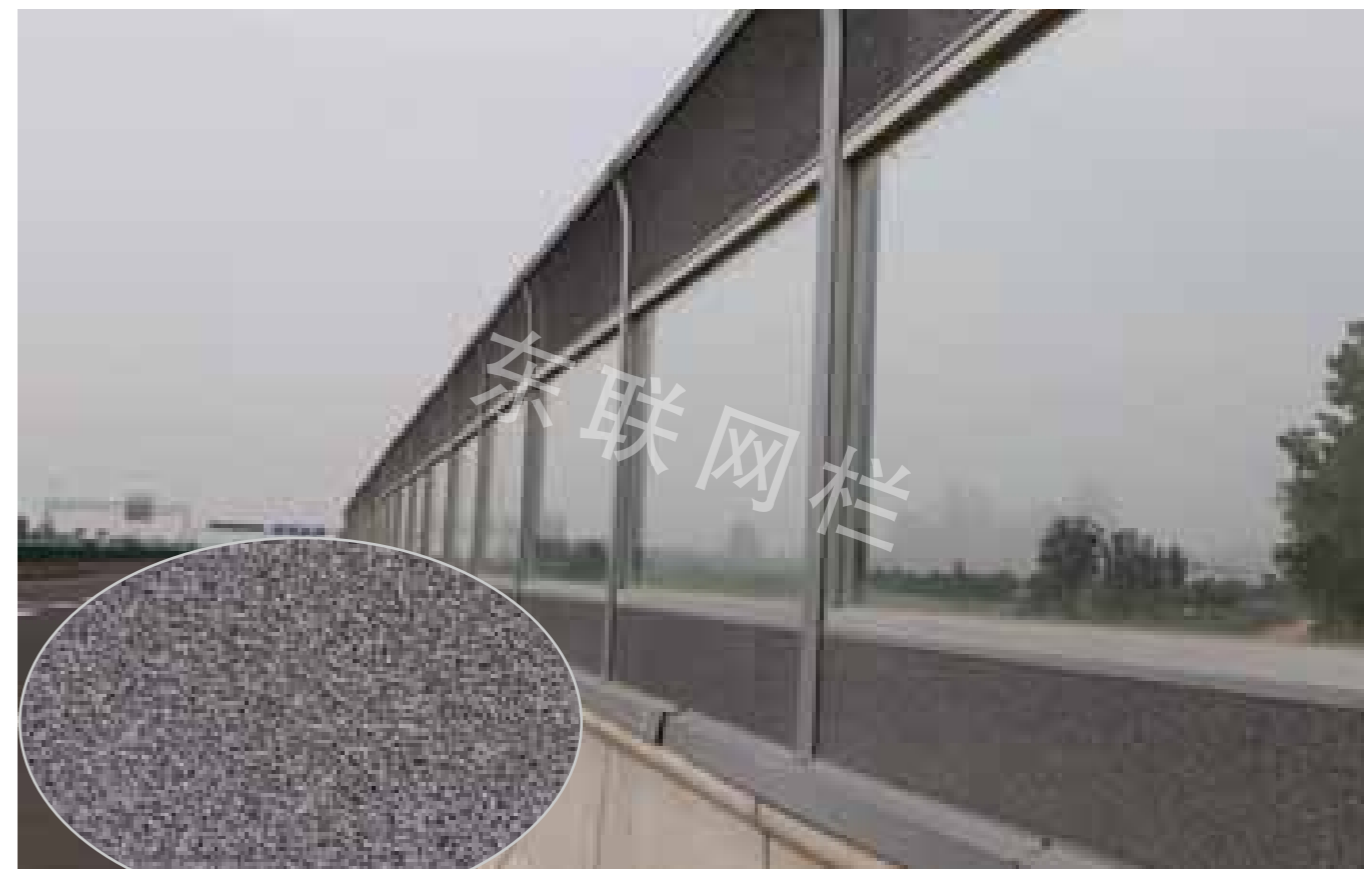

DL-064



DL-063



DL-065

◎ 交通护栏

Traffic Fence



※ 分体京式护栏 / Split Beijing Type Fencing

- ◆ 美观大方、高强度、抗腐蚀性强。
- ◆ 高温固化层，抗腐防锈性能长达20年。
- ◆ 用于城市交通要道、二级公路、绿化隔离带的美化与防护。
- ◆ 超强粘合力，重砸情况下表面依然光洁平整。
- ◆ Nice, high strength, corrosion resistance.
- ◆ High temperature curing layer, rust corrosion performance up to 20 years.
- ◆ For urban roads, secondary roads, greenbelt landscaping and protection.
- ◆ Super adhesive force, heavy smashing case is still flat and smooth surface.

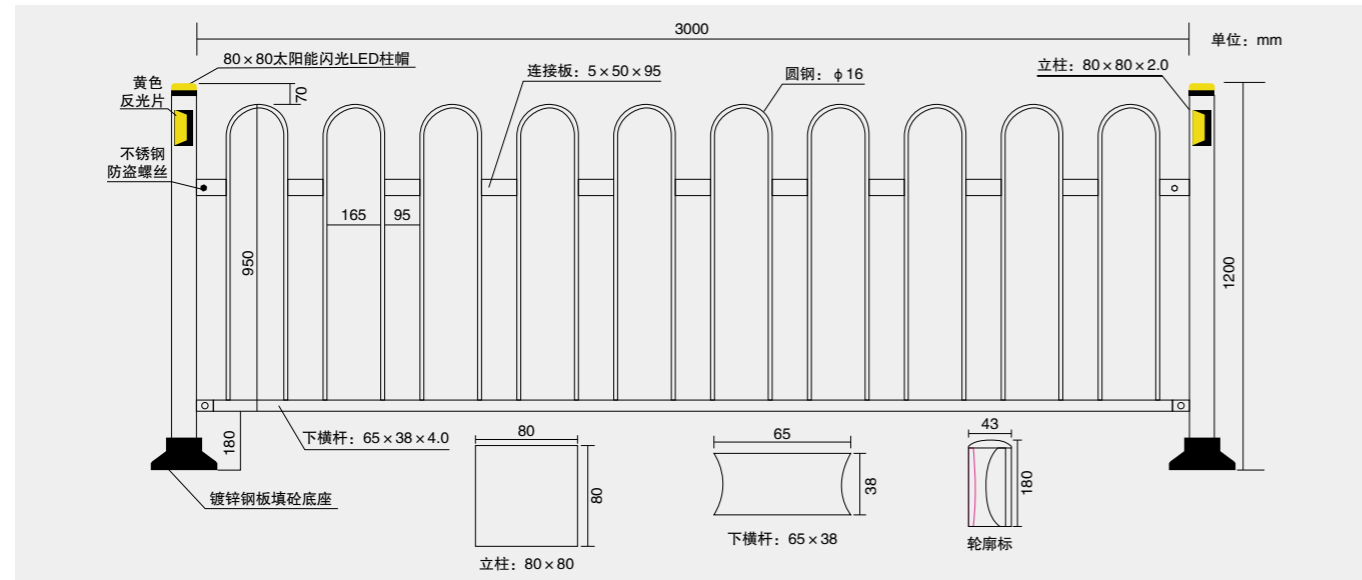

DL-066

※ 京式道路护栏 / Beijing Type Road Fence

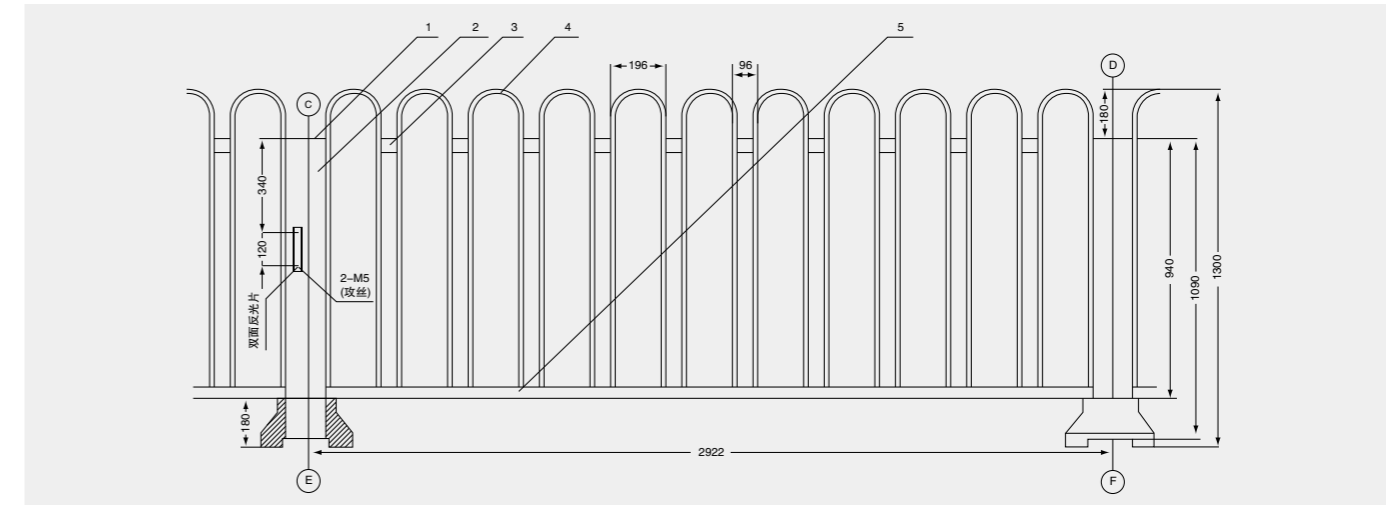

1. 要求每3扇护栏加装一组反光片（每扇护栏立柱一端双面攻丝）。
2. CE、EF、DF的长度误差小于5mm。
3. 立柱与横梁接缝处为双面焊接。
4. 护栏圈头要求在同一平面内，误差小于5mm。
5. 护栏除锈后镀锌喷塑（浸塑）处理。
6. 安装后两立柱要求等高，误差小于5mm。

1. Request: Every 3 piece fence add 1 series Reflectors (every fence post use Tapping sided fix).
2. The error of the length of the CE, EF and DF is less than 5mm.
3. The connection point of the post and beam is double welded.
4. Request the fence top at one flat, the error is less than 5mm.
5. After rust the fence, then PVC painted or PVC coated.
6. After Installation, request the two post at same height, and the error is less than 5mm.

	名称	规格	重量
1	插盖板	钢板 t=4	0.57
2	立柱	槽钢 6.3	27.47
3	筋板	扁钢 50×6	1.51
4	栅栏	圆钢 φ16	39.34
5	横梁	槽钢 6.3	18.54
6	镀锌螺栓	M5×15	



DL-067

※黄金交通护栏 / Gold Traffic Barrier

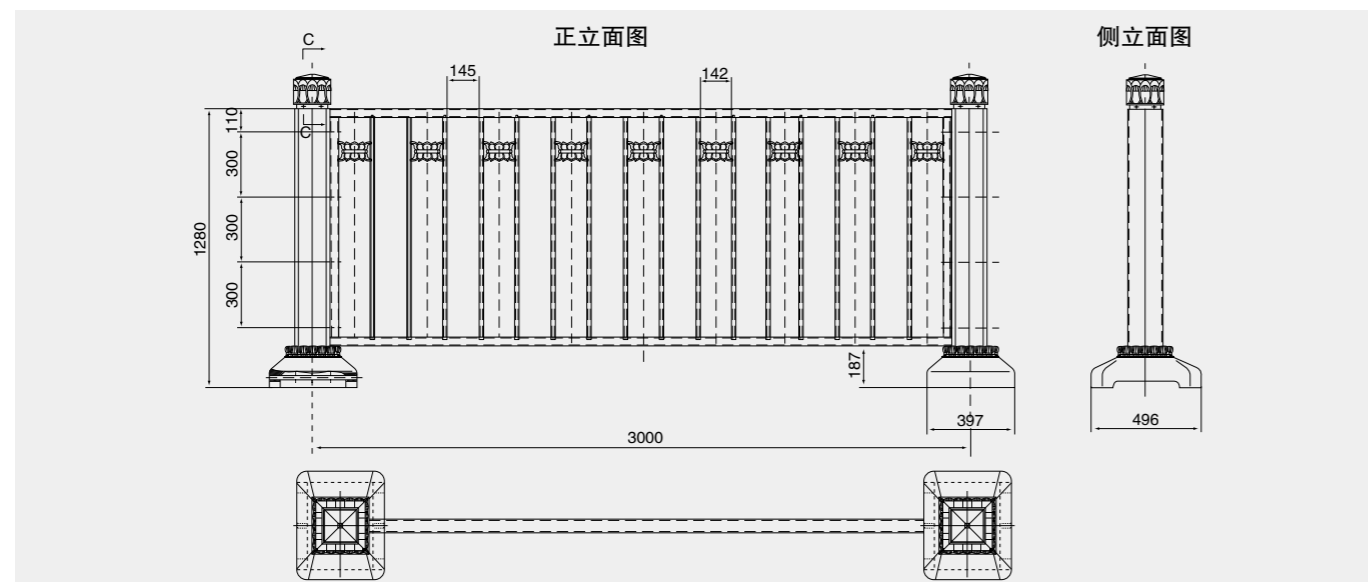

DL-068

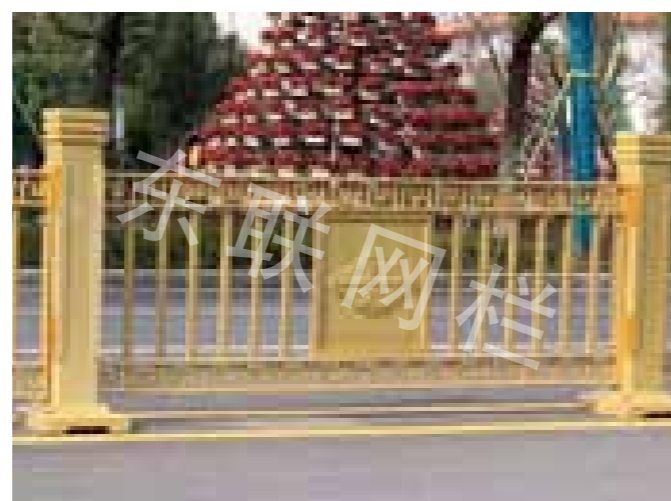

DL-069



DL-070

※黄金交通护栏 / Gold Traffic Barrier



DL-071



DL-072

※ 锌钢道路护栏 / Zinc-Steel Highway Fencing

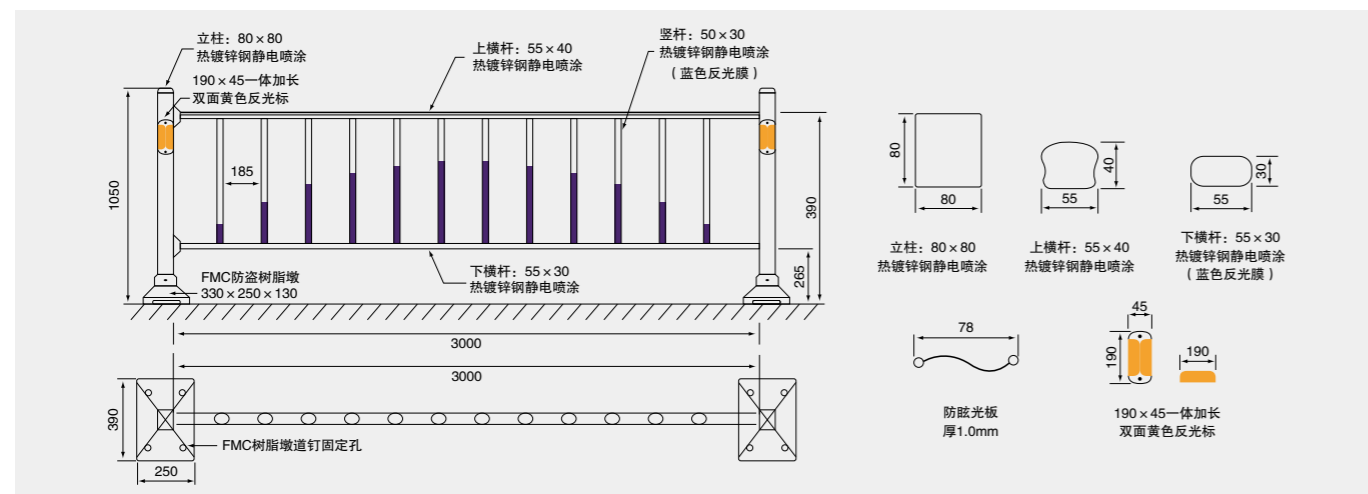

※ 锌钢道路护栏 / Zinc-Steel Highway Fencing

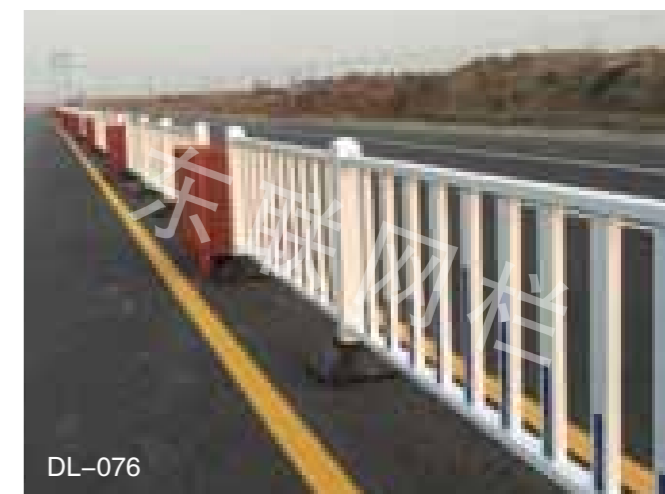

※道路护栏 / Road Fence



DL-079

※道路护栏 / Road Fence



DL-081



DL-080



DL-082

◎ 临时护栏

Temporary Fence



DL-083



DL-084



DL-086



DL-087



DL-085



DL-088

◎ 基坑护栏

Foundation Pit



※ 国标通用示意图 / Diagram of World General Standard

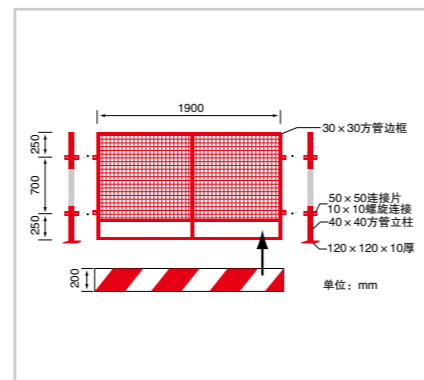
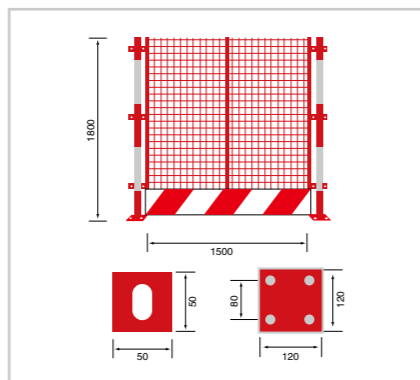
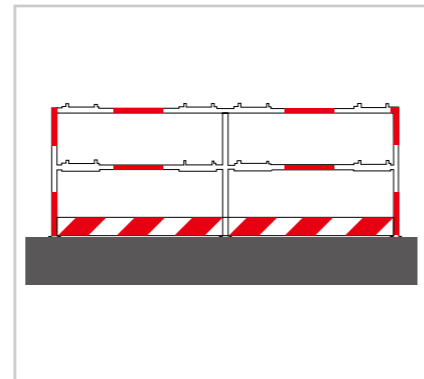
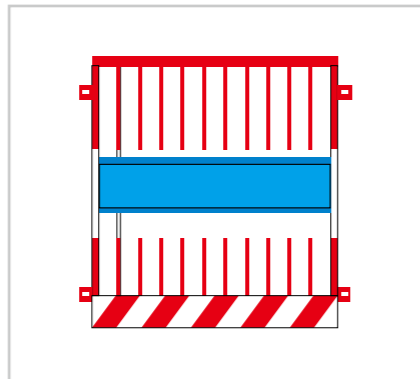
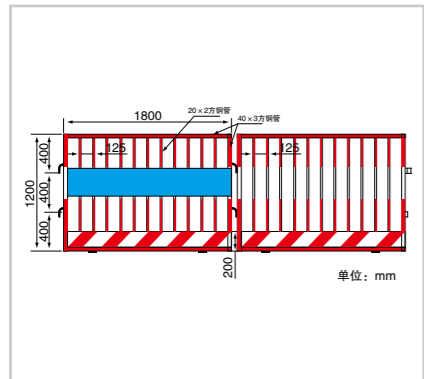
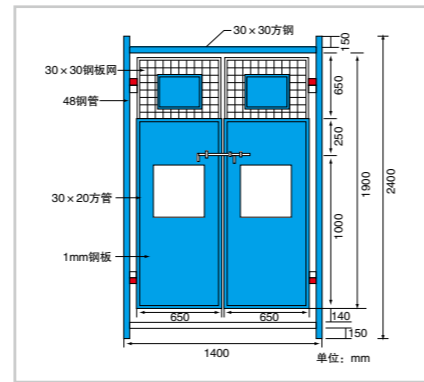
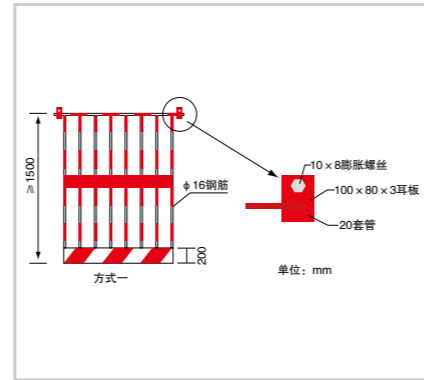
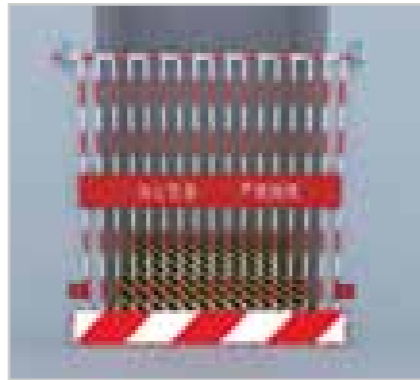
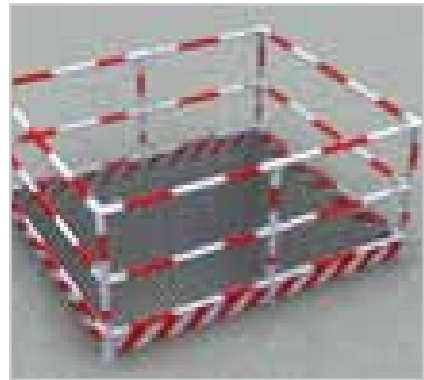

DL-089



DL-090



DL-091



DL-092



DL-093



DL-094

◎爬架网

Climbing Frame Net



DL-095



DL-096



DL-097

◎安全标准化

Safety Standardization



DL-098



DL-99



DL-100



DL-101



DL-102

◎ 机场防护网

Airport Fence



机场护栏网，是用于飞机场周边起安全防范的一种护栏网。机场护栏网造型一般为Y字型，它在原有的基础上加装了刀片刺绳，大大增加了安全防范性能。下面网片结构简练便于运输。安装不受地形起伏限制，多弯地带适应性极强。主要用于飞机场周边防护。尤其适用于国家重要的机关场所和重要的企事业单位。

Airport fence is a kind of safety and security fence around the airport. Airport Fence is generally Y-shaped, fitted with razor barbed wire, which greatly increases the security performance. The mesh under the razor has simple structure and easy to transport. It is installed without any requirement for terrain, highly adaptive for bending zones. It is mainly used for protection and safety around the airport. It is also used in important national institutions and enterprises.



DL-103



DL-105



DL-104



DL-106

◎ 监狱防攀爬隔离网

High Security Prison Fence

监狱高安全防护网,采用大直径高强度合金钢丝制作,具有防攀爬、抗冲击、抗剪切特性和良好的震慑作用,专用于监狱看守所、警戒线军事基地等高安全领域。

安装实例: 狱墙顶部安装、沿警戒线安装、AB门封闭、巡逻道内侧安装、生活生产区隔离。

The prison fence is made by 4.0mm (5.0mm ± 0.10mm) steel wire and designed to be anti-climb, shock resistance and extremely difficult to cut by normal hand tools. Mainly used in military prison.



DL-107



DL-108



DL-109



DL-110



DL-111



DL-112

◎ 体育场围网

Stadium Fence



运动场护栏适用于网球场、足球场、排球场，满足学校、机关、企事业单位健身设施的需求，其外观整齐，抗冲击力强且有弹性，小区楼群中的运动场更需要隔离。

Sport ground mesh fence, mainly used for tennis courts, soccer fields, volleyball courts, can meet the needs of schools, institutions, enterprises fitness facilities. It is especially suited for sport area between buildings, because of neat appearance, strong anti-impact and flexibility.



DL-113



DL-115



DL-114



DL-116

◎ 锌钢护栏

Zinc Steel Fence



采用高品质热镀锌钢管，竖杆顶部通过重型冲压机完美冲压成尖状。横杆冲压出与竖杆匹配的孔洞，竖杆与横杆通过穿插组合安装，并配有精致小卡扣连接，使竖杆与横杆牢固结合，或者横杆与竖杆直接焊接，形成完美围栏，极具艺术性与使用性。

Zinc Steel Fence is also known as picket fence, ornamental fence. The panels are manufactured using the highest-strength steel pickets and rails (aluminum pickets and rails on request), and are available in a wide range of sizes and styles. Panels are attached with high-strength steel or aluminum brackets to powder-coated square tubular steel or aluminum posts. The fence is easy to handle and install, nice appearance, so it is widely used in gardens, schools, factories, pools, residential, industrial and commercial security projects.

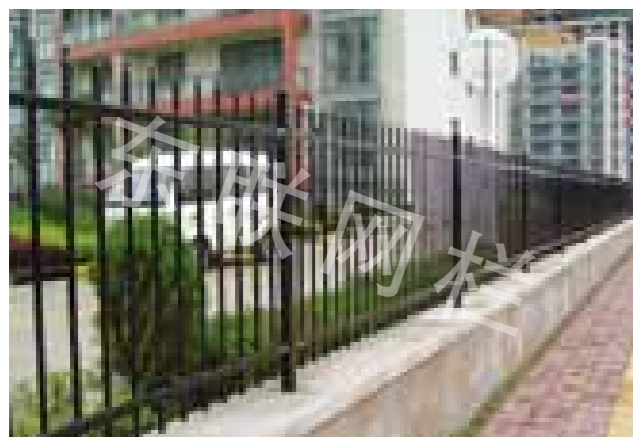

DL-117



DL-118



DL-119

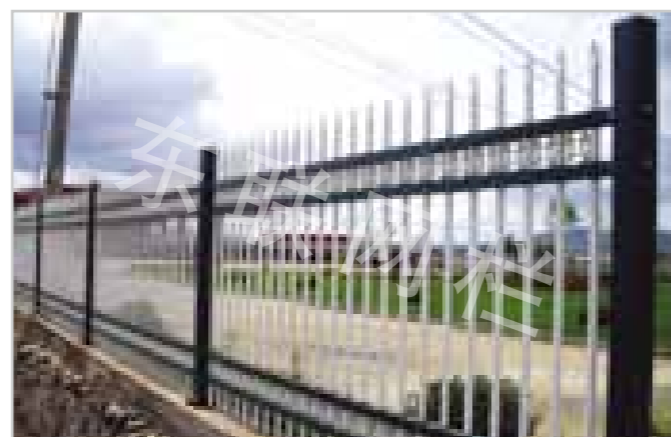

DL-120



DL-121



DL-122

◎ 欧式护栏

Palisade Fence



欧式铁栅栏因其密集锐利的刀尖令人畏惧，难以接近。顶部样式有传统的“D”型轮廓和增加安全的“W”型轮廓。

铁栅栏的高度可达3.6米。

包装形式：可以组装成网片形式，或配合螺栓或铆钉捆绑在一起。

铁栅栏的表面处理：镀锌或镀锌加彩色涂层。

用途：被广泛应用在小区住所、车库、生物园、公园、停车场、社区、学校、草坪。

Palisade fence is finished after suppression of hot dipped galvanized steel plate, colored steel plate. It's very stable, easy to install, anti-rust, non maintenance, moreover it also has best quality, unique profile design, different colors etc. Mainly used in villa, houses, garages, industrial plants, park, garden, community, school, lawn etc.



DL-123



DL-124

◎桃型柱护栏

Peach-Shaped Fencing

桃型柱防护网是一种新型产品，现主要流行于美、日、韩等发达国家及国内较大城市，具有美观大方、不受地形起伏限制及安装方便等特点。

Peach-shaped fencing is a new product popular in many developed countries, including the U.S.A., Japan and South Korea and in large cities of China. It is beautiful, suitable for any hypsography, and convenient in installation.



DL-125



DL-126



DL-128



DL-127



DL-129

◎石笼网(格宾网)

Gabion Mesh

石笼网，也称大规格六角网，或格宾网，由优质钢丝拧机拧编而成，可以制成石笼、石垫。本产品用途十分广泛。可用于边坡防护、基坑支护、山体岩面挂网喷浆、边坡、野生动植物保护区的防护、铁路高速公路隔离护栏网，还可用于江河、堤坝及海塘的防冲刷保护以及水库、河流截流用乱石网箱。

Stone cage, also called big size hexagonal wire mesh or gabion mesh, is made of high-quality steel wire by the automatic gabion machine. This product is widely used in slope protection, foundation pit supporting, mountain rock face net-suspended spray, slope, protection of wildlife refuge, railway highway isolation guarding block, it also can make the stone cage, stone mattress, used in rivers and dams and seawall scour protection and prevention of the reservoir, river closure by stoning cages.

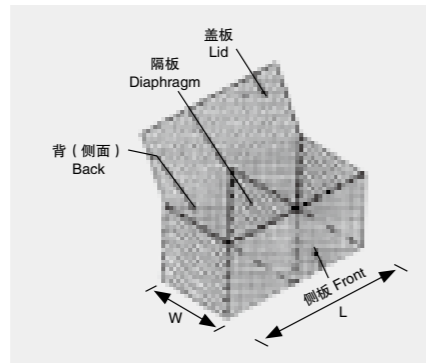
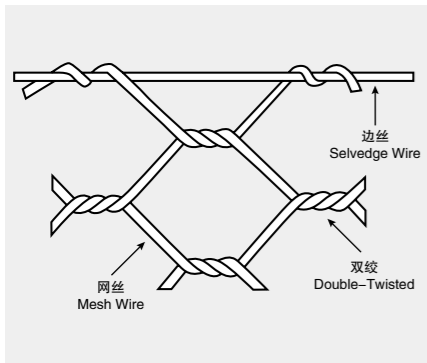

DL-130



DL-132



DL-133

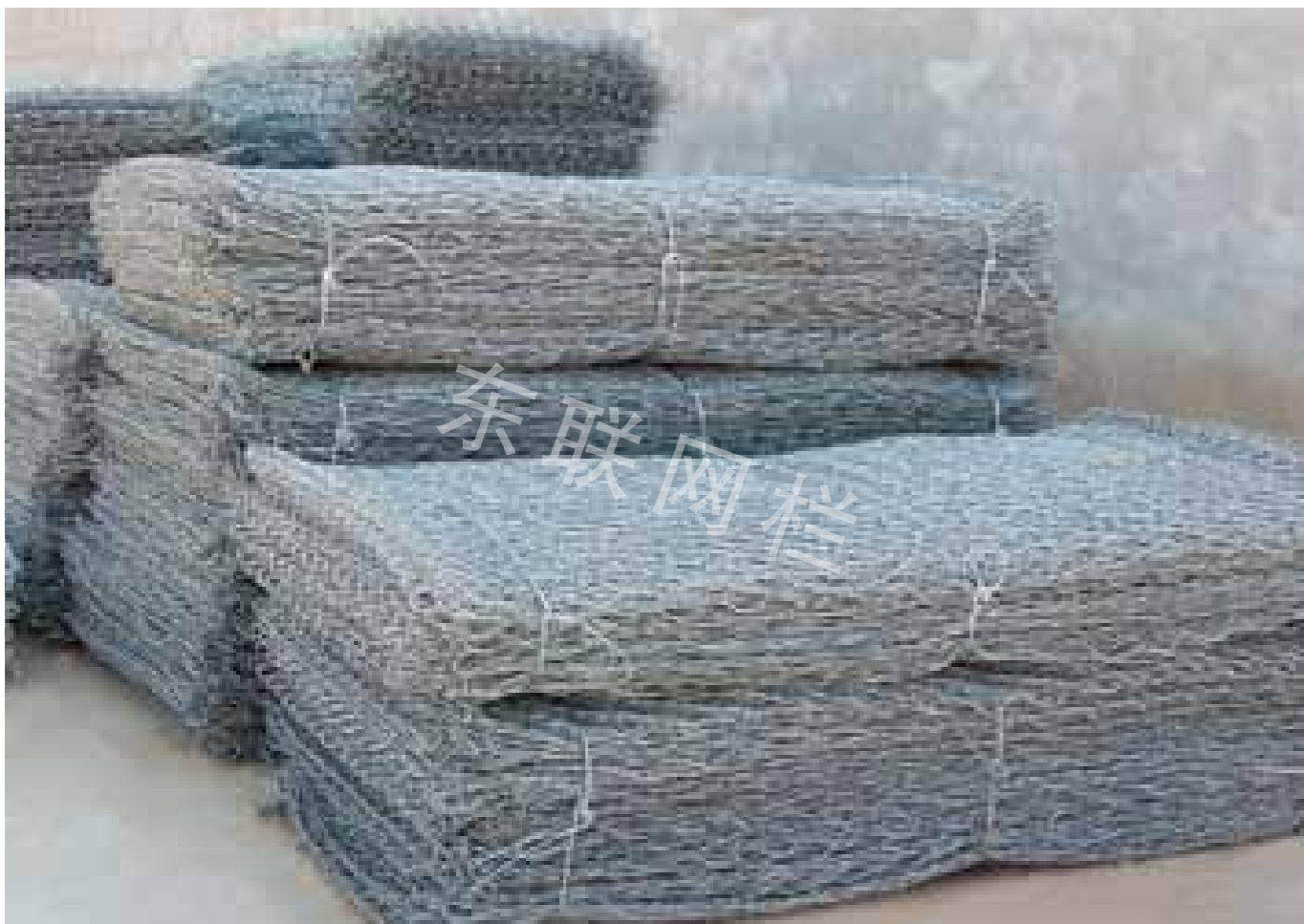

DL-131



DL-134

◎ 边坡防护网

Defend Slope Fence



※ 主动防护网 / Active Protection Network

主动网：采用钢丝绳锚杆或钢筋锚杆和支撑绳固定方式，钢丝绳柔性网覆盖在具有潜在地质灾害的坡面上，从而实现坡面加固或限制落石运动范围的一种防护网。

Active network: Fixed by steel wire rope anchor or reinforced anchor and support, the steel rope flexible network covers the slope of potential geological hazards, achieving slope reinforcement or preventing the range of motion of falling rocks.

主动防护系统特点：以热镀锌钢丝绳为主要材料的主动防护系统具有高韧性、高防护强度、易铺展性等。通过多次边坡防护工程的现场试验和对比，具有适应任何坡面地形、安装程序标准化、系统化等优点。

The characteristics of Active Protection Network: SNS fence, made of Hot dipped Galvanized wire rope, has high tenacity, high protective, and good spreadability. According to many experiments of Side Slope Protection Project, Our product can adapt any terrain slope, has standard and systematic installing methods.

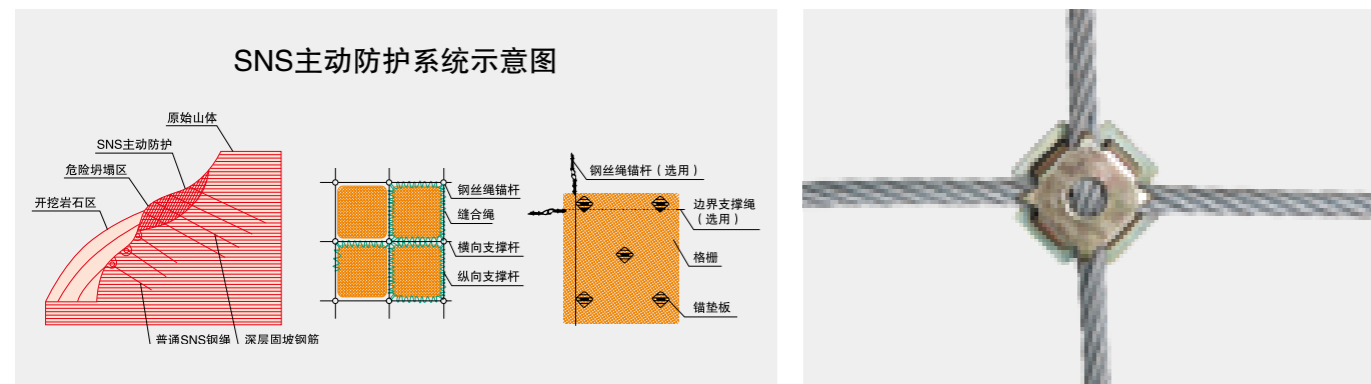

DL-135

※ 被动防护网 / Passive Protection Fence

被动网：采用锚杆、钢柱、支撑绳和拉锚绳等固定方式，将金属柔性网以一定的角度安装在坡面上，形成栅栏形式的拦石网，从而实现落石和泥石流流体中固体物质拦截的一种防护网。

Passive fence: Fixed by bolt, steel columns, support ropes and anchor ropes, the metal flexible fence is fixed at a certain angle in the slope, forming protection fence to stop falling rocks and solid material in debris flow.

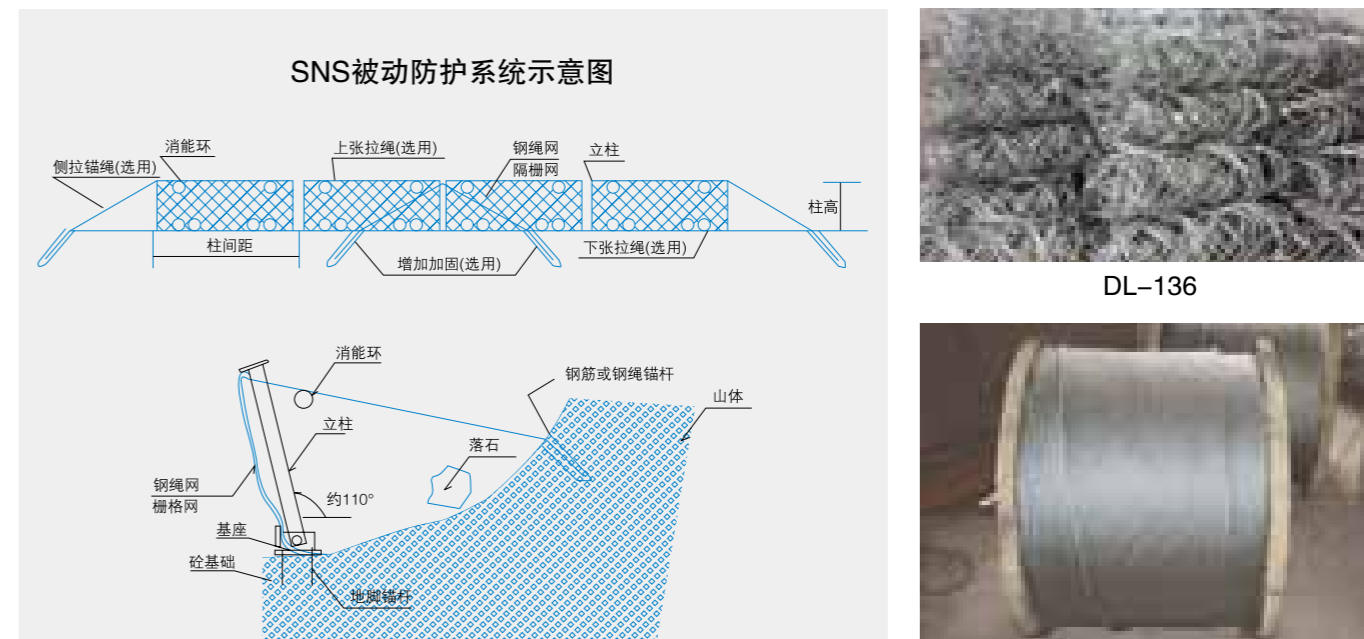

DL-138

◎ 防风抑尘网

Dust Suppression and Wind Proofing Wall



DL-139

单峰型 (单体)
Single Hump (monomer)

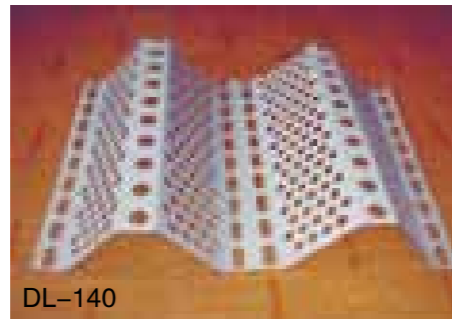

DL-140

双峰型 (双体)
Double Humps (bimodal)



DL-141

三峰型 (三联体)
Three Humps (triad)

材质: 钢板、镀锌板、彩钢板、不锈钢板。
表面处理: 静电粉末喷涂。

应用范围:

- ◆ 发电厂、煤矿、焦化厂、洗煤厂等企业的储煤场。
- ◆ 港口、码头储煤场及各种料场。
- ◆ 钢铁、建材、水泥等企业各种露天料场。
- ◆ 铁路、公路煤炭集运站储煤场。
- ◆ 建筑工地、道路扬尘。

Material: Steel, galvanized sheet, color steel, stainless steel plate.

Surface Treatment: Electrostatic powder coating.

Application:

- ◆ Power plants, coal mines, coking plants, coal washing plant, and other businesses to save coal field.
- ◆ Ports, terminals and markets a variety of coal storage yard.
- ◆ Iron and steel, building materials, cement companies such as a variety of open-air yard.
- ◆ Coal storage and station of Railway and highway transportation.
- ◆ Build Sites, road to suppress dust.



DL-142

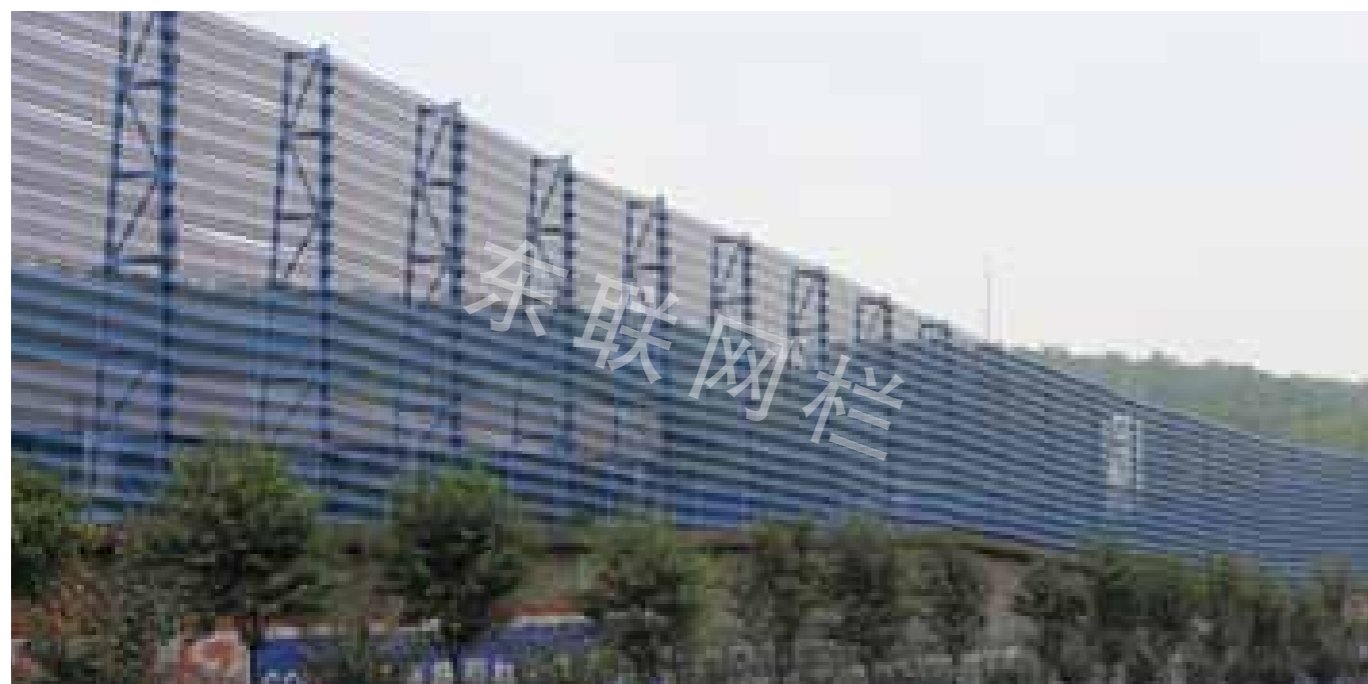

DL-143



DL-144



DL-145

◎ 钢格板

Steel Grating

压焊钢格板是由负荷扁钢和横杆按一定间距经纬排列，采用 200 吨液压电阻焊自动化设备焊接成原板，经切割、开孔、包边等工序加工而成客户要求的产品。

受荷扁钢间距：两相邻受荷扁钢的中心距，常用 30mm、40mm 两种。

横杆间距：两相邻横杆的中心距通常为 50mm、100mm 两种，特殊规格可按客户要求定做。

The press welded steel grating, requested by the customers, is made of load flat steel bar and cross bars, placed horizontally and vertically, and at an equal pitch apart, by welding with 200-ton hydraulic resistance automatic welding equipment, then cutting, punching and banding ends.

Load bearing steel bar pitch: Pitch between the two neighboring load bearing steel bars is 30mm or 40mm.

Cross bar pitch: Pitch between two neighboring cross bars is usually 50mm or 100mm. Special specifications can be done according to your request.

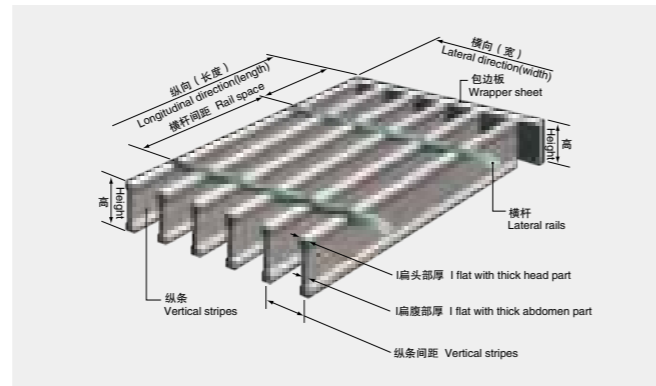

DL-146



DL-147



DL-148



DL-149



DL-150



DL-151



DL-152