



# 苏州艾斯科电器

Suzhou Esco Electrical



团队



坚持



合作



荣誉



## 1.1 企业简介



苏州艾斯科电器专注于成为专业精密嵌件注塑零部件解决方案提供商。以先进的模具设计开发制造，精密冲压和精密注塑能力为汽车行业、银行设备、医疗器械等行业提供专业的零件和组装总成服务。主要产品有：各类汽车传感器、控制器壳体及各种功能结构件，点钞机外观壳体及内部结构件，及各类精密塑胶零件。公司拥有完善的质量控制体系，通过IATF6949体系认证，并获得高新技术企业荣誉。

现有人员：50人

**经营理念：**专业，创新，以客户为中心！

**品质方针：**以精立业，以质取胜！

**环境方针：**做一家有社会责任感的公司！

## 1.2 发展历程

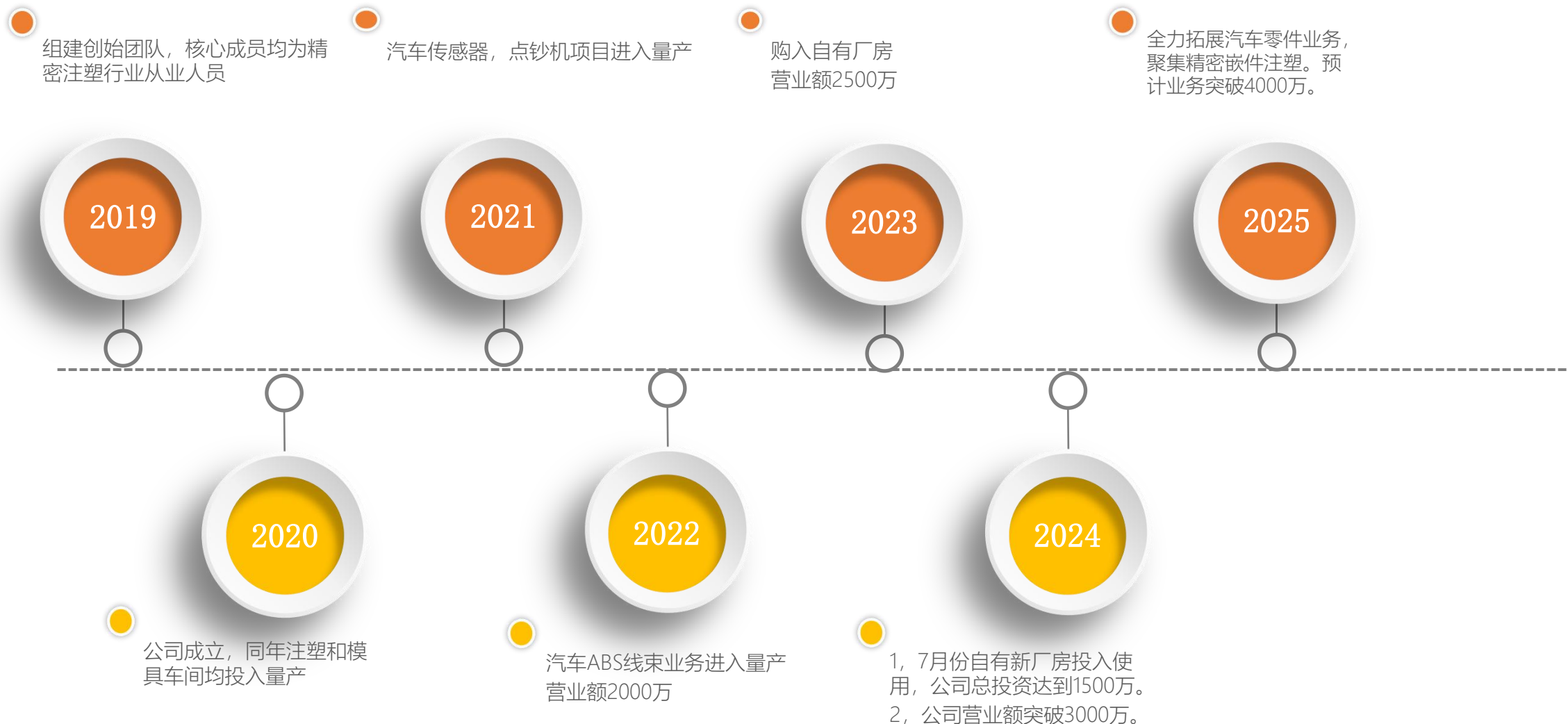

## 1.3 企业荣誉



## 1.5 主要客户



红旗

让理想飞扬



CB  
OTOMASYON VE MÜHENDİSLİK  
SANAYİ VE TİCARET LİMİTED ŞİRKETİ  
choice of the best



MicroDe



敏之捷传感  
MZJ SENSOR



大运  
DAYUN



masetec  
sensing the world.



HOZON  
合众汽车



哈啰出行



RIBAO  
TECHNOLOGY



清智科技  
TSINTEL TECHNOLOGY



NINJA



FOTILE 方太  
因爱伟大

## 1.6 企业文化

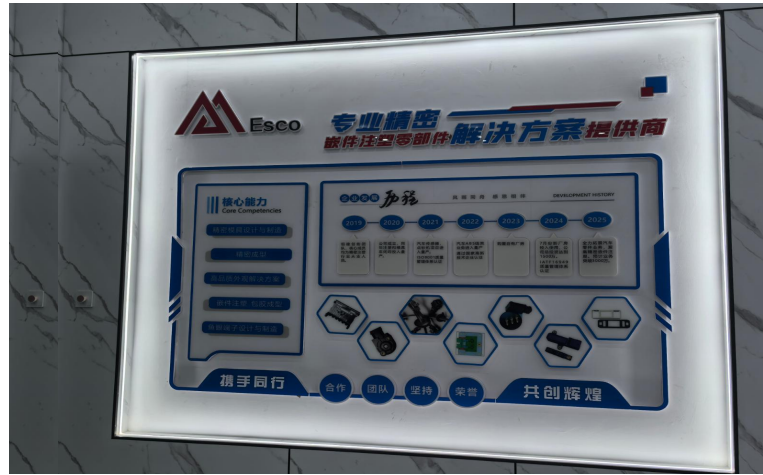

# 产品介绍

(我们做什么)

## 2.1 汽车零件

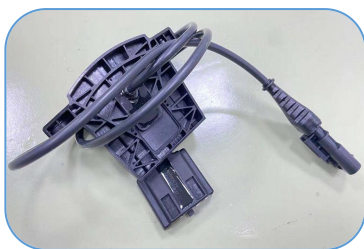

**线性位移传感器壳体**  
用于离合器, PRD档位置检测等  
**Pin针、铜套、磁铁嵌件注塑**

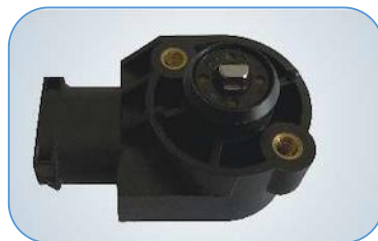

**角度传感器壳体**  
刹车踏板, 油门踏板角度检测, 无人驾驶车轮方向检测等.  
**鱼眼Pin针、铜套、转动轴铜套嵌件注塑**

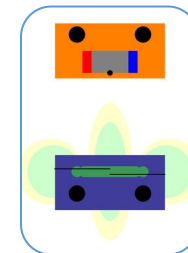

**位置传感器壳体**  
车门打开, 关闭等位置检测  
壳体需保证开口变形, 内部灌密封胶

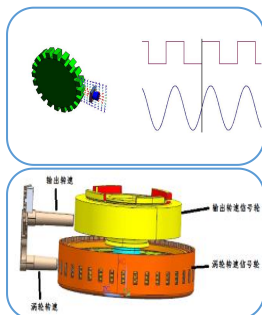

**速度传感器骨架与包胶模**  
ABS轮速, 发动机齿轮, 变速箱齿轮等速度检测  
**Leadframe 嵌件注塑、芯片电阻焊后包胶注塑**  
**Pin针铜套嵌件注塑**

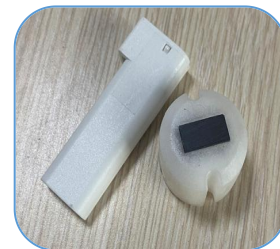

**液位传感器壳体**  
检测冷却液, 雨刮水等液位  
**Pin针、磁铁嵌件注塑**

## 2.1 汽车零件

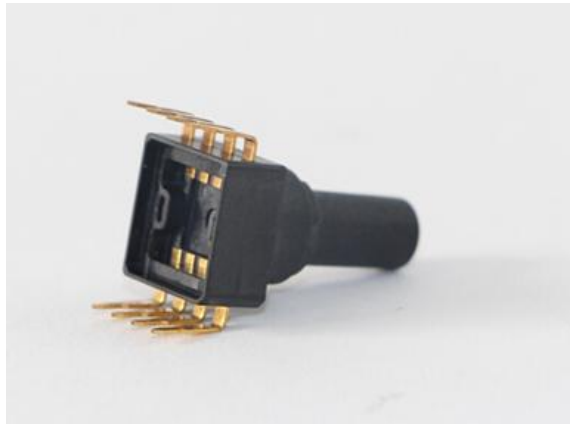

## 2.2 汽车零件



## 2.3 新能源汽车零件

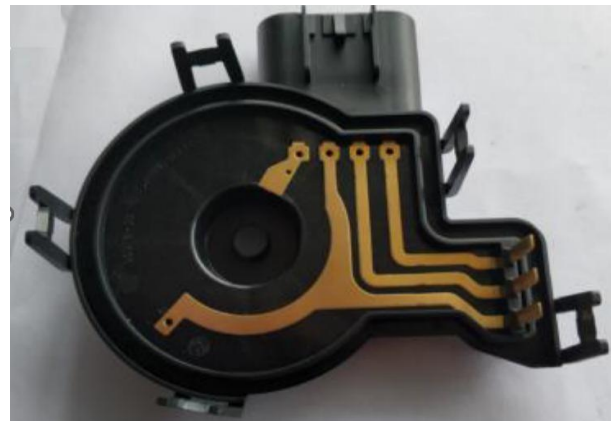
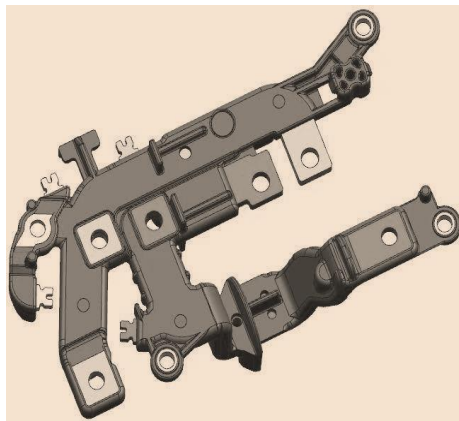
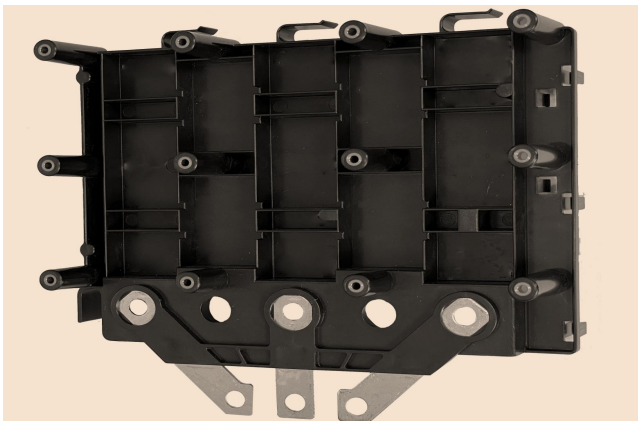

## 2.4 各类汽车线束



ABS/EPB 线束防水头，安装卡位注塑成型

## 2.4 核心能力 完全自主知识产权的系列化鱼眼端子产品

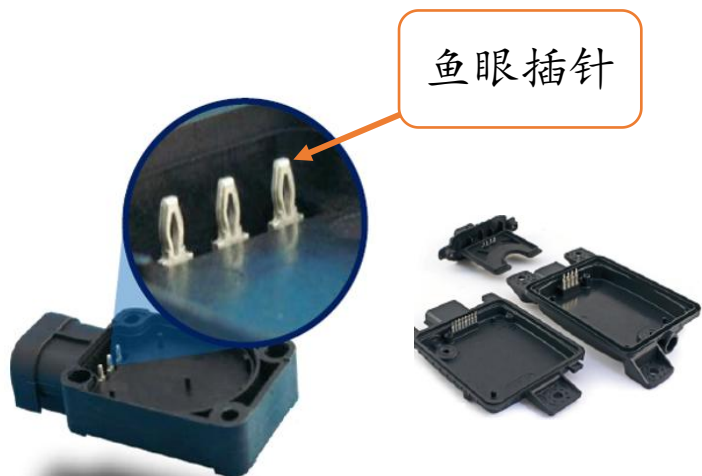

### 汽车精密嵌件注塑

- 鱼眼插针嵌件注塑，免焊设计
- 常规Pin针嵌件注塑
- 各类铜套、卷圆件嵌件注塑



## 2.4 鱼眼端子

专利设计、独特外形  
Patented Design, Unique Shape

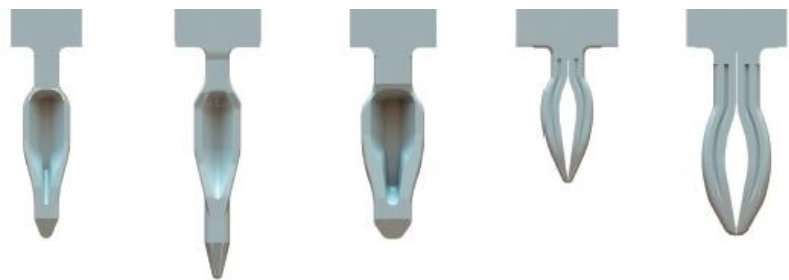

全系列的鱼眼端子产品  
(完全自主研发设计、  
拥有国家发明专利)

插入力小、拔出力大

✓ Small insert force, big retention force

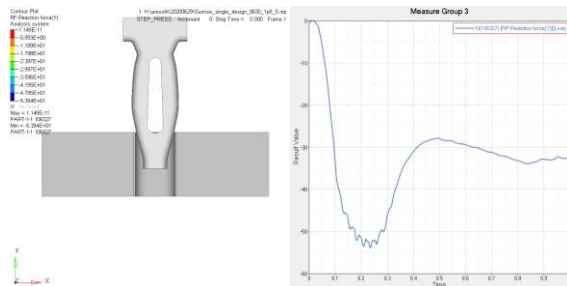

插入方便，抗振动能力强

■ Easy insertion and strong anti-vibration capacity

孔变形小

✓ Small PTH deformation



对孔的破坏小，保证良好的接触状态

■ Small damage to the PTH to ensure good contact status

接触面积大、接触应力小、接触电阻小  
Big contact area, big contact Force, small contact pressure



业内领先的70%PCB板孔接触长度，与孔贴合饱满，使接触电阻小且稳定

■ Industry leading 70% PTH contact length, and hole fit fully, so that the contact resistance is small and stable

自主知识产权的鱼眼端子拥有：更大保持力，更大接触面积，更小接触应力，更小接触电阻

## 2.4 鱼眼端子

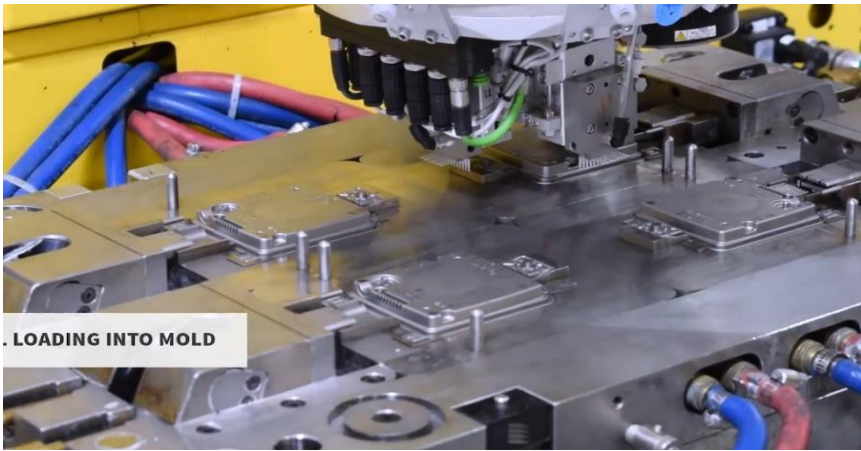

控制器/雷达  
Controller/Radar



传感器/天线  
Sensor/Antenna



特殊连接器  
Special Connector

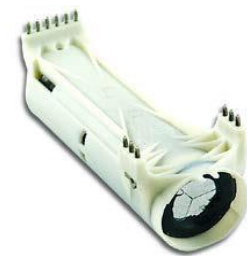

电容  
Capacitance

## 2.4 鱼眼端子及相关产品在汽车行业上的应用



Motor & Flapper Controls

电机和挡板控制



胎压监测

Tire Pressure Monitors



Component Holders

零件支架

HiTEN 2009 - Oxford



Molded Sensor & Control Modules  
传感器模块和控制模块

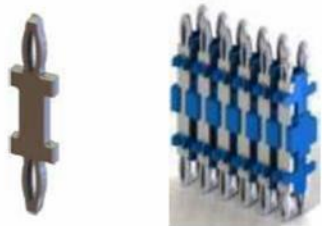
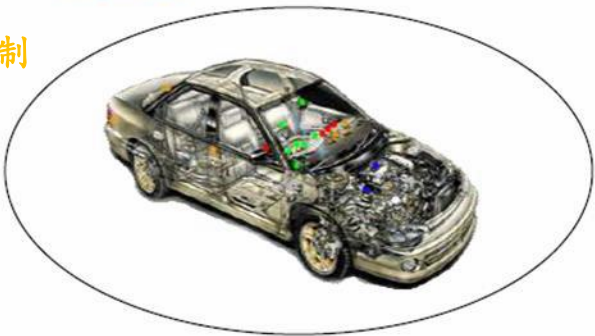

Solder Less Circuit Stacking Applications

无焊接电路堆栈应用

Bus Bar Interconnects & Fuse Receptacles

铜排内部连接和熔断器插座



接线盒

Junction Boxes



Engine & Transmission Controllers

发动机变速箱控制器

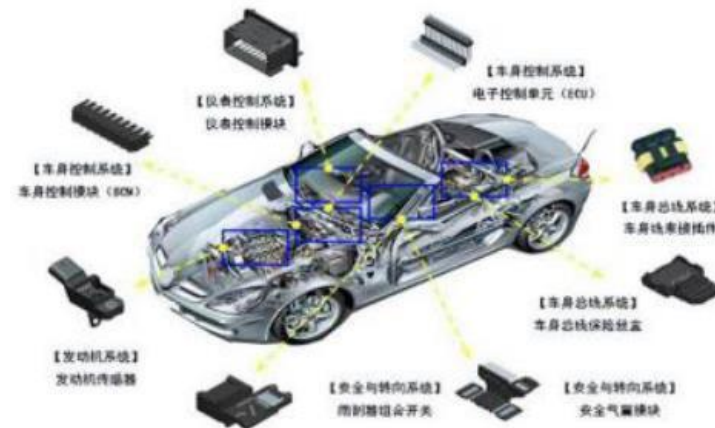

## 2.5 点钞机

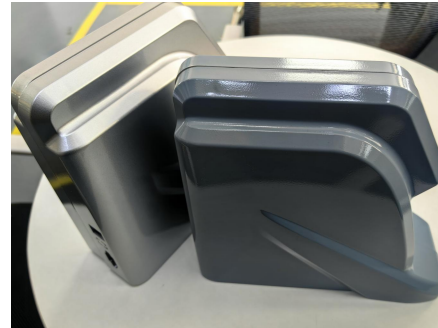
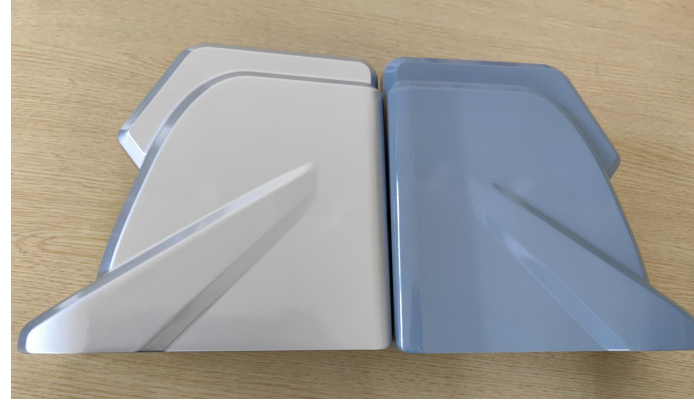

零部件后端工艺：喷漆，电镀，丝印，镭雕；

## 2.5 点钞机

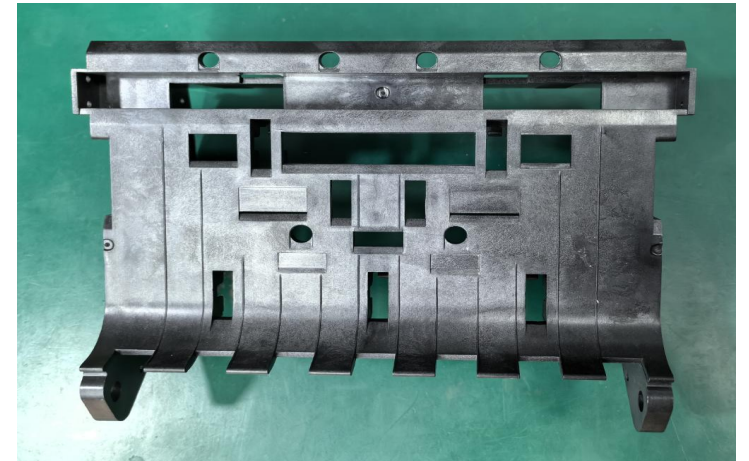
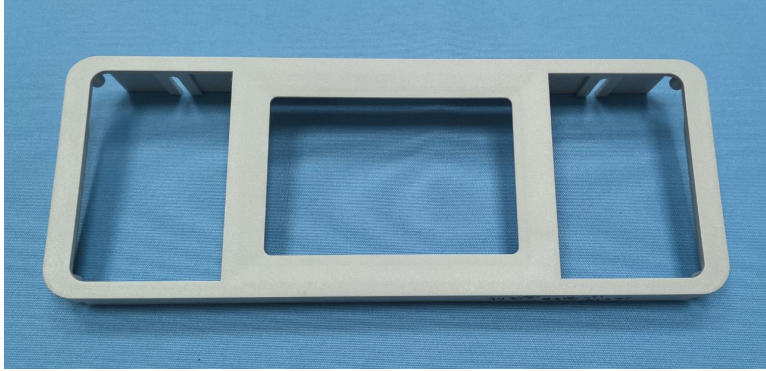

特殊材料控制产品变形量和静电去除;

## 2.6 医疗器械

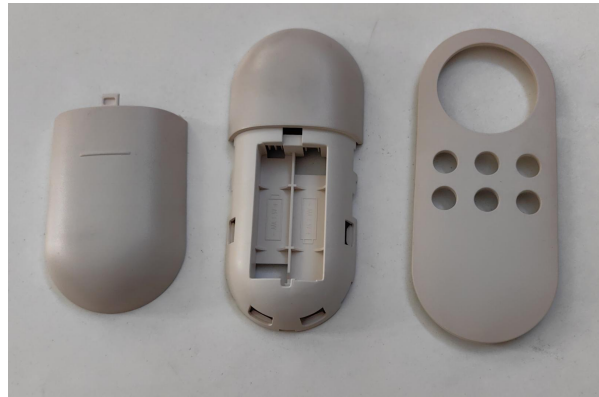

高品质皮纹，提升产品外观品质；



# 设备介绍

## 2.7 模具车间



镜面火花机/慢走丝



CNC加工中心



组模车间

## 2.8 注塑设备

### 二车间



吨位排布: 35T——500T

### 一车间



### 转盘机

### 立式机台



## 2.9 检测设备一



三坐标



投影仪

## 2.9 检测设备二

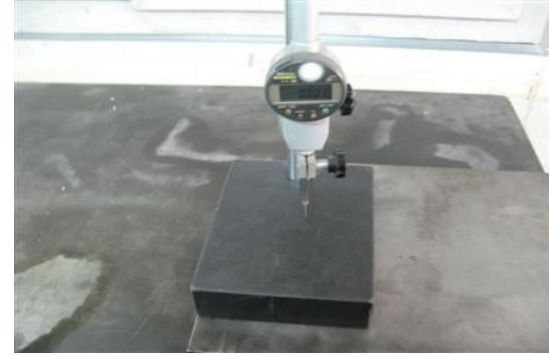

# 谢谢聆听



团队



坚持



合作



荣誉

