



中山市沃蓝达照明有限公司

ZHONGSHAN WOLANDA LIGHTING CO., LTD.

生产基地：广东中山市古镇镇曹二均都沙工业区曹安南路19号

Production base: No.19,Caoan South road,Caoer Jundusha

Industrial Zone,Guzhen Town, Zhongshan City.

电话/Tel: 0760-86995991 传真/Fax: 0760-86995991

手机/Mobile: 陈先生 15889890615 / 刘小姐 18688100656

E-mail: 463176616@qq.com

Http://www.ledwolanda.com https://wolandaled.1688.com

专业户外楼宇/景观亮化/工程照明配套服务商

中山市沃蓝达照明有限公司

ZHONGSHAN WOLANDA LIGHTING CO., LTD.

COMPANY PROFILE

公司简介

本公司是专业提供城市照明规划、城市景观照明规划与设计、建筑物外立面和环境照明规划与设计、照明智能控制和管理规划与设计的专业公司，为城市环境照明规划与设计服务。

本公司的主要产品有洗墙灯、线条灯、户外壁灯、点光源、瓦楞灯、投光灯、埋地灯、水下灯、喷泉灯、护栏管、太阳能路灯、庭院灯等几十种系列近万个产品品种，可全方位满足市场多元化需求。

公司面对目前照明市场激烈的竞争环境，始终坚持产品科技创新为先，不断提高产品科技含量，使产品具有工艺精湛、安全节能、安装简便、使用长久、美观的特点，产品被广泛选用到城市建设的各类重点工程中，以完善及时的售前、售中、售后服务让用户满意。

我们将“以科技求发展、以诚信为纽带、以质量为本、以服务为基础、以市场为导向”的企业理念为广大的客户提供“优质的产品、完善的服务、齐全的品种、优惠的价格”。

我们将以国际上灯光照明先进的设计软件和超前的设计理念，为广大客户提供城市环境照明和建筑物夜景照明规划和设计，真诚的希望能与您携手共进，合作双赢，共创辉煌。



LED OUTDOOR LIGHTING PRODUCT BROCHURE LED 户外亮化产品手册



WORLD
沃蓝达照明

WORLD
沃蓝达照明

QUALITY
品质

QUALITY
品质

品质就是生存

品质经历了岁月的洗礼而更显可贵，
那样的朴实，而不凡，
就如同生命一般值得坚持，
钻石品质，精益求精。

WORLD
沃蓝达照明

WORLD
沃蓝达照明

WORLD
沃蓝达

INDEX
目录

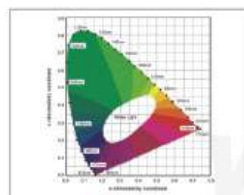

照明知识
LIGHTING KNOWLEDGE

006-013



LED户外亮化效果图鉴赏
LIGHTING EFFECT DRAWING

014-027



LED洗墙灯系列
LED WASH WALL LAMP SERIES

028-055



LED水纹灯系列
LED WATER PATTERN LAMP SERIES

200-201



LED瓦楞灯
LED CORRUGATED LAMP SERIES

202-207



LED抱树灯系列
LED HOLDING TREE LAMP SERIES

208-213



LED线条灯系列
LED LINELAE LIGHT SERIES

056-075



LED像素灯系列
LED PIXEL ARTICLE SERIES

076-077



LED护栏管系列
LED GUARDRAIL TUBE SERIES

078-081



LED窗台灯系列
LED WINDOW LIGHT SERIES

214-217



LED导光板系列
LED GUIDE LIGHT PLATE SERIES

218-219



LED户外壁灯系列
LED OUTDOOR WALL LAMP SERIES

220-227



LED投光灯系列
LED FLOOD LIGHT SERIES

082-124



LED插地灯系列
LED INSERT GROUND LAMP SERIES

025-127



LED隧道灯系列
LED TUNNEL LAMP SERIES

128-137



LED软灯带系列
LED FLEXIBLE LIGHTS SERIES

228-231



LED点光源系列
LED POINT LIGHT SERIES

232-243



LED流星管系列
LED METEOR TUBE SERIES

244-245



LED路灯系列
LED STREET LAMP SERIES

138-161



LED水底灯系列
LED UNDERWATER LAMP SERIES

162-173



LED埋地灯系列
LED BURIED LAMP SERIES

174-187



中国结&灯笼系列
CHINESE KNOT & LANTERNS SERIES

246-247



LED太阳能路灯系列
LED SOLAR STREET LIGHT SERIES

248-253



LED庭院灯系列
LED YARD LAMP SERIES

254-257



LED步道灯系列
LED TRAIL LIGHTS SERIES

188-189



LED工矿灯系列
LED MINING LAMP SERIES

190-197



LED护栏灯系列
LED GUARDRAIL LAMP SERIES

198-199



LED草坪灯系列
LED LAWN LAMP SERIES

258-260

LED光源的优点 / The light source has the advantages of

1、新型绿色环保光源：LED运用冷光源，眩光小，无辐射，使用中不产生有害物质。LED的工作电压低，采用直流驱动方式，超低功耗（单管0.03~0.06W），电光功率转换接近100%，在相同照明效果下比传统光源节能80%以上。LED的环保效益更佳，光谱中没有紫外线和红外线，而且废弃物可回收，没有污染，不含汞元素，可以安全触摸，属于典型的绿色照明光源。

2、寿命长：LED为固体冷光源，环氧树脂封装，抗震动，灯体内也没有松动部分，不存在灯丝发光易烧、热沉积、光衰等缺点，使用寿命可达6万~10万小时，是传统光源使用寿命的10倍以上。LED性能稳定,可在-30°C~+50°C环境下正常工作。

3、多变换：LED光源可利用红、绿、蓝三基色原理，在计算技术控制下使用三种颜色具有256级灰度并任意混合，即可产生256x256x256(即16777216)种颜色，形成不同光色的组合。LED组合的光色变化多端，可实现丰富多彩的动态变化效果及各种图像。

4、高新技术：与传统光源的发光效果相比,LED光源是低压微电子产品,成功融合了计算机技、网络通信技术、图像外理技术、嵌入式控制技术。传统LED灯中使用的芯片尺寸为0.25mmx0.25mm，而照明用LED的尺寸一般都要在1.0mmx1.0mm以上。LED裸片成型的工作式结构、倒金字塔结构和倒装芯片设计能够改善其发光效率，从而发出更多的光。LED封装设计方面的革新包括高传导率金属块基底、倒装芯片设计和裸盘浇铸式引线框等，采用这些方法都能设计出高功率、低热阻的器件，而且这些器件的照度比传统LED产品的照度更大

目前一个典型的高光通量LED器件能够产生几流明到数十流明的光通量，更新设计可以在一个器件中集成更多的LED，或者在单个组装件中安装多个器件从而使输出的流明数相当于小型白炽灯，例如，一个高功率的12芯片单色LED器件能够输出200lm的光能量，所水泵的功率在10~15W之间。

LED光源的应用非常灵活，可以做成点、线、面各种形式的轻薄短小产品；LED的控制极为方便，只要调整电流，就可以随意调光；不同光色的组合变化多端，利用时序控制电路，可能达到丰富多彩的动态变化效果，LED已经被广泛应用于各种照明设备中，如电池供电的闪光灯、微型声控制、安全照明灯、室外道路和室内楼梯照明灯以及建筑物与标记连续照明灯。

白光LED的出现，是LED从标识功能向照明功能跨出实质性的一步。白光LED最接近日光，更能较好地反映照射物体的真实颜色，所以从技术角度看，白光LED无疑是LED最尖端的技术。目前，白光LED已开始进入一些应用领域，应急灯、手电筒、闪光灯等产品相继问世，是由于价格十分昂贵，故而难以普及。白光LED普及的前提是价格下降，而价格下降必须在白色LED形成一定市场规模后才有可能，两者的融合最终有赖于技术进步。

照明知识 / Lighting basic terms

■ 显色性

在人工光源的照射下，人的眼睛对物体真实颜色辨别的差异，我们通常称为光源的“显色指数”，用“Ra”表示。显色指数越大，表示光源对物体真实颜色的再现能力越强。

■ 色温（K）

当光源所发出光的颜色与黑体在某一温度下辐射的颜色相同时，黑体的温度就称该光源的色温。黑体的温度越高，光谱中蓝色的成分则越多，而红色的成分则越少。例如：白炽灯的光色是暖白色，其色温表示为2700K，而日光色荧光灯的色温表示方法则是6000K

■ 灯具效率

灯具效率（也叫光输出系数）是衡量灯具利用能量效率的重要标准，它是灯具输出的光能量与灯具内光源输出的光能量之间的比例。

■ Color performance

Under irradiation in the artificial light sources, there is difference to distinct the real color by people' s eyes. It is called "color-rendering index", or "Ra". The greater color-rendering index, the better show the true colors of objects.

■ Color temperature(K)

When the ray color sent by lamp-house is the same with that from black body, the temperature of the "black body" is called the color temperature of lamp-house. The higher of its temperature is, the more blue is, and the less red is. For example: the light color of incandescent lamp is warm white with color temperature 2700K, but the temperature of sunlight is stated at 6000K.

■ Lighting efficiency

Lighting efficiency (also called as light output coefficient) is efficiency standards to measure lighting energy, It is ratio about input and output lamp light energy

LED基础知识 The LED Basic Knowledge

什么是LED?

Light Emitting Diode, (发光二极管)是一种半导体固体发光器件,它是利用固体半导体芯片作为发光材料,当两端加上正向电压,半导体中的载流子发生复合引起光子发射而产生光。

LED的结构

LED主要由以下几个部分组成:

- 芯片:(作用光源发光)
- 支架:包括衬底及散热基座、引脚等(作用:散热、导电)
- 金线(作用:导电)
- 环氧树脂(作用:保护晶粒、透光)

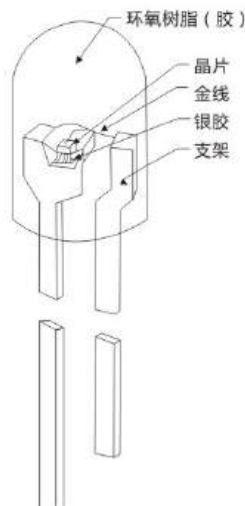

大功率集成封装芯片

现有的LED封装技术已从单晶的LED光源发展出多晶封装的产品(其他说法胶集成芯片)。多晶封装的LED光源的LED光源每块流明输出可达2000Lm

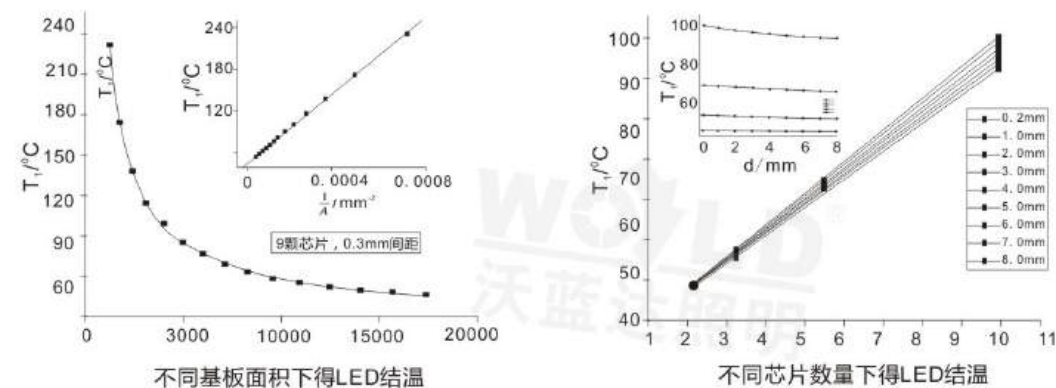

灯具防电击等级

Class1:灯具不仅置于基本的颜色绝缘体上,还安置了另安全的防护体,把可导体的部分连接到一个安全的导体上。(接地)
Class2:为了防止电击,灯具不仅置于基本绝缘本上,还安置另一安全防护体,加固双绝缘体。
Class3:为了防止电击,灯具接上安全超低压电源,(交流有效值小于50V)且灯内不会产生高于此值的电压

灯具IP防护等级

按IEC标准和国际GB7001-86“灯具外壳防护等级的分类”的规定,防护等级代号用IP字母和两个特征的数字组成,第一位特征的数字指防护形式,第二位的数字的特征指防护等级。

LED灯具常见分类:

- 室内照明灯具:筒灯、天花灯、格栅灯盘、T5/T8支架日光灯管、轨道灯、吸顶灯、水晶灯、花灯、壁灯等。
- 室外照明灯具:投光灯、防爆灯、路灯、隧道灯、洗墙灯、水底灯、埋地灯、工矿灯、壁灯、瓦楞灯、太阳能路灯、庭院灯、草坪灯、楼宇亮化(LED护栏管、流星管、点光源、)等。

1931 色品图 1931 Cie Chromaticity Diagram

国际照明委员会在1931年制定颜色的表示方法1931 CIE色品图利用色坐标X-Y去描述人眼可见光,在色图的边沿外是单色光,而色度内的颜色是由某单色光和白色混合而成,越靠近白色,色越白。

The Commission International De Eclairage (CIE) invented a method for representing color in 1931. The monochromatic colors are at the edge of the diagram, while inside is the mixed color made by one monochromatic color and the white color, with the white color in the middle.

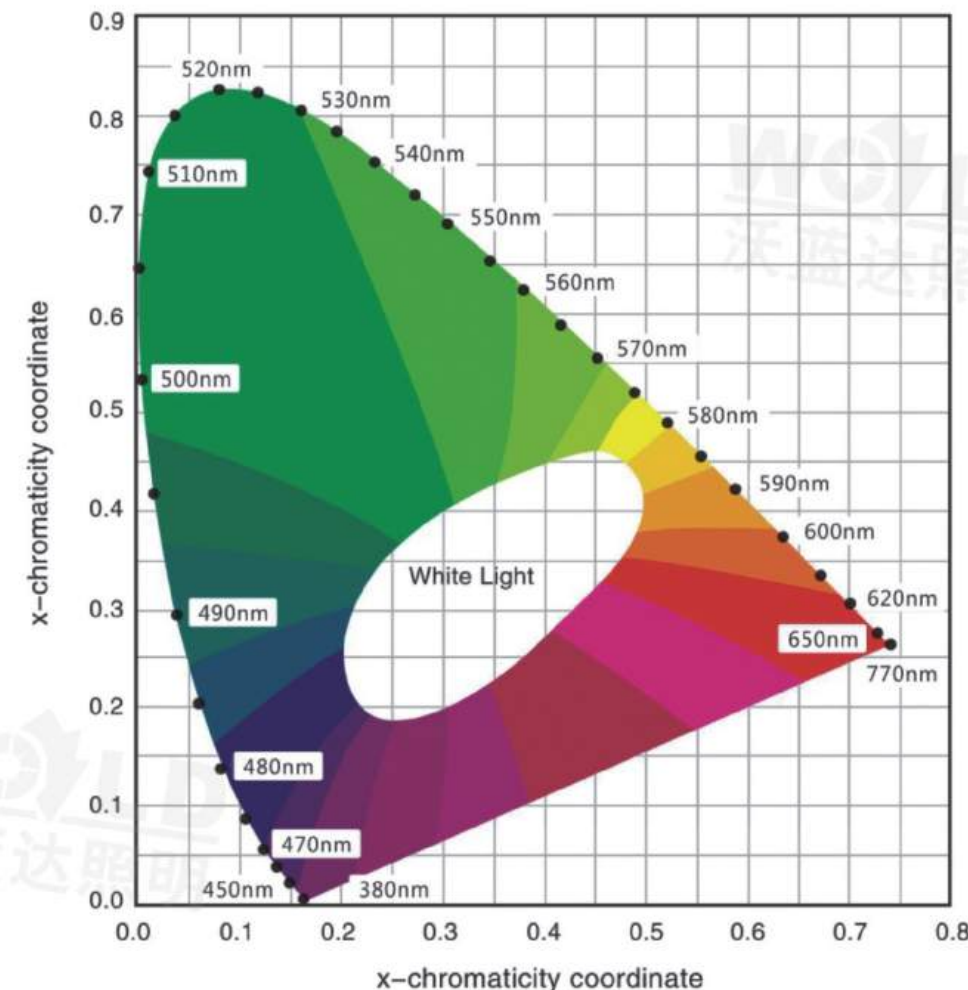

光色应用 The application of the light color

- 暖色光：暖色光的色温在3000K左右，暖色光与白炽灯相近，能给人以温暖、健康、舒适的感觉。适用于家庭、住宅、宿舍、宾馆等场所或温度比较低的地方
- 白色光：又叫中性色，它的色温在4000K左右，中性色由于光线柔和使人有愉快、舒适、安详的感觉。适用于商店、医院、办公室、饭店、候车室等场所。
- 冷色光：又叫日光色，它的色温在6000K左右，光源接近自然光，有明亮的感觉，使人精力集中。适用于办公室、会议室、教室、绘图室、图书馆的阅览室、展览橱窗等场所。
- Warm white
Warm white: warm white is under 3300K, it is similar with warm incandescent light, give a warm, healthy, comfortable feeling for user. Applicable to family, home, dormitories, hotels and other premises or places where the temperature is relatively low.
- White
White: also known as a neutral color, its color temperature between 3300-5300K, neutral, soft, pleasant, comfortable, quiet. Applicable to shops, hospitals, offices, restaurants, waiting rooms, etc.
- Cool white
Cool white: also known as daylight color, its color temperature is more over 5300K and above the light source close to natural light, a bright feeling, concentration. Applicable to offices, conference rooms, classrooms, drawing rooms, library, reading room, exhibition, windows, etc.



显色指数与显色性的关系 The relationship of color-rendering index and color performance

- 当光源光谱中很少或缺乏物体在基准光源下所反射的主波时，会使颜色产生明显的color shift色差程度越大，光源对该色的显色性越差。显色指数系数 (Kau fman) 仍为目前定义光源显色性评价的普遍方法。
- 白炽灯的显色指数定义为100，视为理想的基准光源。此系统以8种彩度中等的标准色样来检验，比较在测试光源下与在同色温的基准下此8色的偏离 (Deviation) 程度。以测量该光源的显色指数，取平均偏差值Ra20-100，以100为最高，平均色差越大，Ra值越低，低于20的光源通常不适用于一般用途。
- When the light source spectrum or the lack of small objects under the light source in the base of the main wave reflection, the color will have a significant greater degree of color shift color, light source color to the color of the worse. Color-rendering index coefficient (Kau fman) light source is still the current color of the definition of the universal method of evaluation.
- Incandescent color index is defined as 100, as an ideal source of base. This system, the middle of the eight kinds of standard color saturation like to test, compare the test in the same light source with color temperature of the base of the deviation from the 8-color (Deviation) extent. To measure the light source color-rendering index, the average deviation from the value of Ra20-100, to 100 as the highest, with an average difference greater, Ra valuse lower than 20 are usually not suitable for general purpose lighting.

常见知识 Diagrams



室内使用

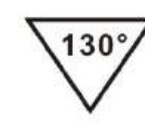

外壳任何部位最温升不超过130°



固有安全隔离短路保护

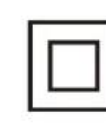

双绝缘二类触电保护



不能暴晒



三类绝缘



防潮

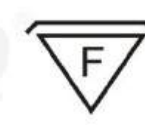

可置于一般可燃物表面安装使用

可置于一般可燃物表面安装使用
灯具背后不能密封和覆盖可置于一般可燃物表面安装使用
(用于电子变压器)

显色性与显色指数相关知识 Color and color rendering index related knowledge

光源对物体的显色能力称为显色性，是通过与同色温的参考或基准光源（白炽灯或画光）下物体外观颜色的比较，光所发射的光谱内容决定光源的光色

但同样光色可由许多，少数甚至仅仅两个单色的光波组合而成。对各个颜色的显色性亦大不相同。相同光色的光源会有相异的光谱组成。光谱组成较广的光源较有可能提供较佳的显色品质

显色分两种

忠实显色：能正确表现物质本来的颜色需使用显色指数（Ra）高的光源，其数值接近100，显色性最好。

效果显色：要鲜明地强调特定色彩，表现美的生活可以利用加色的方法来加强显色效果。

Color performance is light source color on the ability to display objects light source color is the color of objects, and is in the same color temperature of the reference or benchmark light (incandescent light or painting), the comparison of color of objects, the optical spectra of the contents will decide the color of light source.

However, the same light color, can be many, a few or even only two monochromatic light combination. Color of each color are also very different. The same color of light source will be composed of different spectra. Composed of a wide spectrum of light source are more likely to provide better color quality.

Two colors

Faithful color: use some high source with high color-rendering index (Ra) in order to show the color of material, its value close to 100, it is the best color.

Color effects: emphasis on color clear, Please use the methods of additional color in order to enhance the color effect

光学公式 Optical formula

光强 [cd] I Light intensity [cd] I	特定角度内的光通量 特定角度 Ω [Sr]	Specific angle of luminous flux Specific angle Ω [Sr]
照度 [lx] E Illuminance [lx] E	落在物体表面的光通量 [lm] 照明表面积 [m ²]	Falls on the surface of the luminous flux [lm] Illuminated surface area [m ²]
辉度 [Cd/m ²] L Luminance [Cd/m ²] L	光强 [cd] 被观察表面的面积 [m ²]	Light intensity [cd] Surface area was observed [m ²]
光效 [LM/W] H Luminous efficiency [LM/W] H	发射光通量 [lm] 耗电量 [W]	Fired flux [lm] Power consumption [W]

IP (防护等级)

Ingress protection 英文缩写，是国际上用来认定灯具之防护等级的代号。IP等级由两个数字组成来表示灯具的防尘防水等级，第一个数字表示灯具对人、固体异物或尘埃的防护能力，第二个数字表示灯具对水的防护能力，数字越大表示灯具的防护性能越佳。

防尘等级说明

特性号码	防护程度	定义
0	无防护	特殊的防护
1	防止大于50mm的固体侵入	防止人体因不慎碰到灯具内部零件，防止直径大于50mm的固体物件侵入
2	防止大于12mm的固体侵入	防止手指或长度不超过80mm的类似物体碰到灯具内部零件，防止直径大于12mm的固体物件侵入
3	防止大于2.5mm的固体侵入	防止直径或厚度超过2.5mm的工具、电线、固体物件侵入
4	防止大于1.0mm的固体侵入	防止直径或厚度超过1.0mm的电线、蚊蝇或固体物件侵入
5	防尘	不能完全防止灰尘侵入，但侵入的灰尘不足以影响灯具的正常工作
6	防尘	灰尘完全无法侵入灯体内部

防水等级说明

特性号码	防护程度	定义
0	无防护	无特殊的防护
1	防止滴水侵入	防止由上垂直滴落的水侵入灯体
2	倾斜15°时仍防止滴水侵入	当灯具从垂直中心倾斜到15°时，仍可防止由上垂直滴落的水侵入
3	防止喷洒的水侵入	当喷洒的水或雨水，从灯具垂直中心或与垂直中心夹角小于50°这个范围内，由上往下洒向灯体不会影响灯具正常工作
4	防止泼溅的水侵入	从任何方向，泼溅到灯具、灯具的封盖或罩的水都不会影响灯具正常工作
5	防止喷射的水侵入	用喷管从任何方向，对着灯具的封盖或罩喷水都不会影响灯具正常工作
6	防止大浪的水侵入	防止大浪或喷水孔急速喷出的水侵入灯体影响灯具正常工作
7	防止浸水的水侵入	灯具放入水中，在一定时间或水压条件下，仍可确保灯具正常工作
8	防止沉没的影响	在一定的水压条件下，灯具可连续沉没在水中仍可正常工作



防触电保护等级选择

为了电气安全，灯具所有带电部件必须采用绝缘体材料等加以隔离，灯具这种保护人身安全的防护措施称为防触电保护，根据灯具采用防触电保护的方式，可将灯具分为0、I、II、III 四类

灯具等级	灯具主要性能	应用说明
0类	保护依赖基本绝缘在易触及的部分及外壳和带电部件间绝缘	适用安全程度高的场合，且灯具安装、维护方便，如空气干燥、尘灰少、木地板等条件下的吊灯、吸顶灯等
I类	除基本绝缘外，易触及的部分及外壳有接地装置，一旦基本绝缘失效时，不致有危险	用于金属外壳灯牌，如投光灯、路灯、庭院灯等，提高安全程度
II类	除基本绝缘外，还有补充绝缘，做成双重绝缘或加强绝缘，提高安全性	绝缘性好，安全程度高，适用于环境差、人经常触摸的灯具，如台灯、手提灯等
III类	采用特低安全电压(交流有效值小于50V)，且灯内不会产生高于此值的电压	灯具安全程度最高，用于恶劣环境，如机床工作，儿童用灯等

楼体亮化

它起到了美化城市的夜空作用，同时还提升了城市的形象，形成一道和谐、亮丽的风景。成为自我宣传和体现文化和提高知名度，甚至成为标志性建筑的方法。



楼体亮化

它起到了美化城市的夜空作用，同时还提升了城市的形象，形成一道和谐、亮丽的风景。成为自我宣传和体现文化和提高知名度，甚至成为标志性建筑的方法。



楼体亮化

它起到了美化城市的夜空作用，同时还提升了城市的形象，形成一道和谐、亮丽的风景。成为自我宣传和体现文化和提高知名度，甚至成为标志性建筑的方法。



楼体亮化

它起到了美化城市的夜空作用，同时还提升了城市的形象，形成一道和谐、亮丽的风景。成为自我宣传和体现文化和提高知名度，甚至成为标志性建筑的方法。



楼体亮化

它起到了美化城市的夜空作用，同时还提升了城市的形象，形成一道和谐、亮丽的风景。成为自我宣传和体现文化和提高知名度，甚至成为标志性建筑的方法。



桥梁亮化

桥梁装饰照明设计的目的是通过光的强度和颜色变化，突出桥梁的整体形象和建筑特色，达到美化环境的效果。通过五光十色的艺术照明来表现桥梁夜间景观的魅力，使桥梁景观能够展示和扩展为全天候的美学效应，创造出丰富多彩的夜空世界，给人们带来无限的遐想与憧憬。

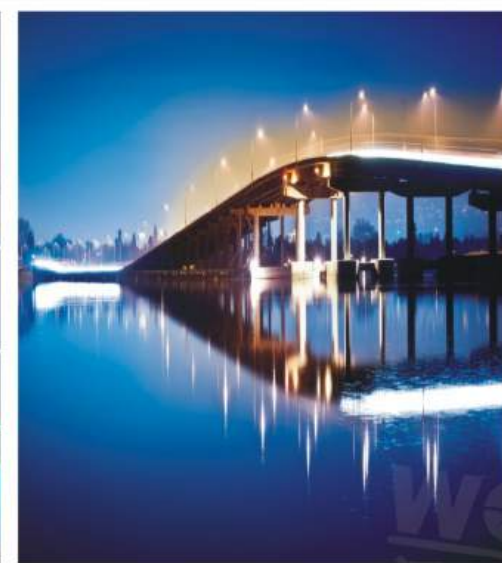

桥梁亮化

桥梁装饰照明设计的目的是通过光的强度和颜色变化，突出桥梁的整体形象和建筑特色，达到美化环境的效果。通过五光十色的艺术照明来表现桥梁夜间景观的魅力，使桥梁景观能够展示和扩展为全天候的美学效应，创造出丰富多彩的夜空世界，给人们带来无限的遐想与憧憬。

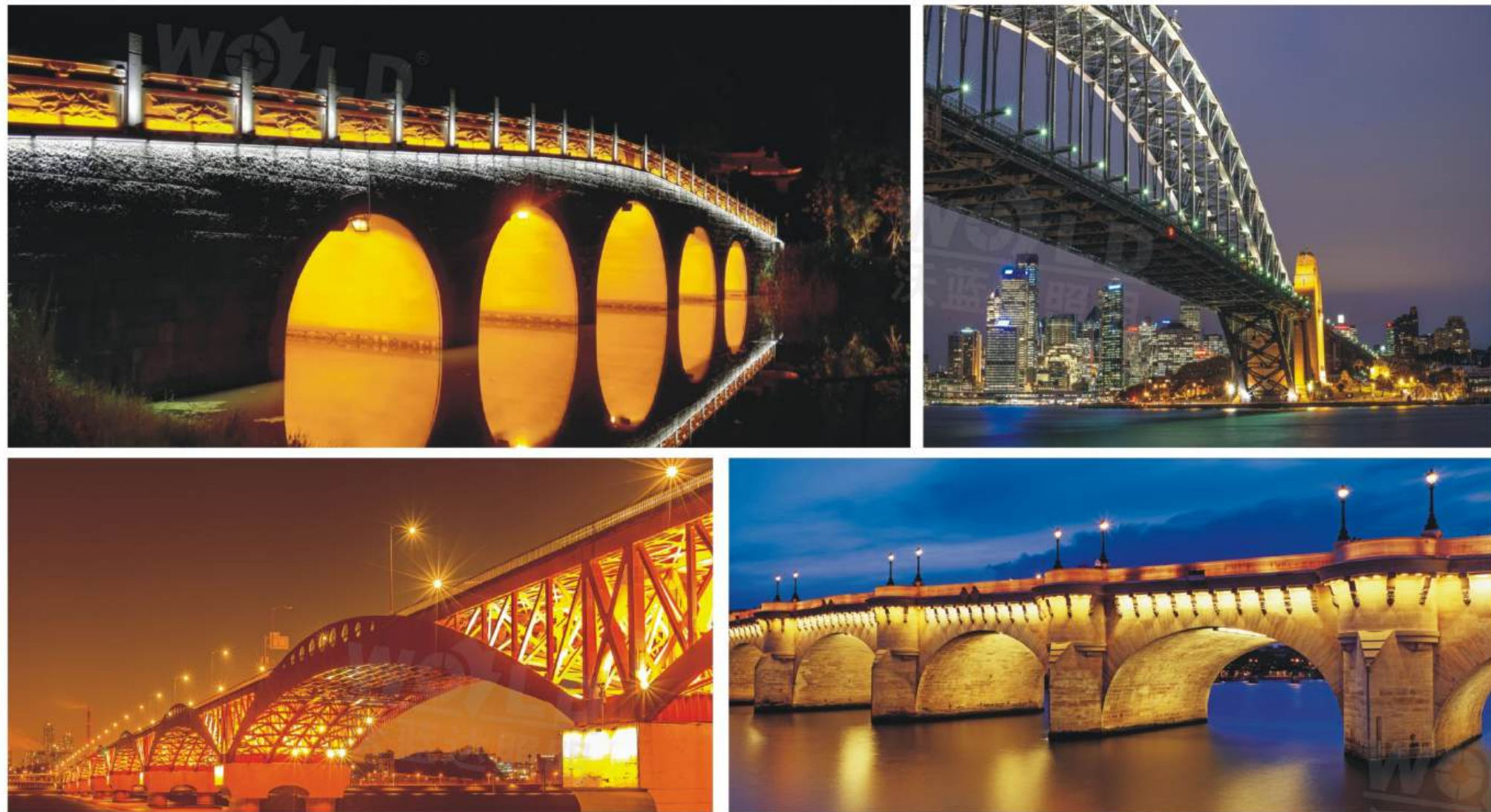

道路亮化

为道路及其附属设施设置的照明。用于提高夜间车辆行驶和行人行走的安全性，防止发生交通事故。合理设置，可以改善交通条件，减少驾驶疲劳，提高道路通行能力，有效减少交通事故。



道路亮化

为道路及其附属设施设置的照明。用于提高夜间车辆行驶和行人行走的安全性，防止发生交通事故。合理设置，可以改善交通条件，减少驾驶疲劳，提高道路通行能力，有效减少交通事故。



广场亮化

集照明、指路和装饰等功能于一身的灯具。由红、绿、蓝组成混合颜色变化可以发出多种颜色，绚丽多彩，美观大方，具有很强的观赏性。一般应用于广场夜景、户外公园、停车场、休闲场所、绿化、草坪、庭院、花坛、步行街等照明，给城市的夜晚增添了新的景观。



LED户外亮化效果图鉴赏

广场亮化

集照明、指路和装饰等功能于一身的灯具。由红、绿、蓝组成混合颜色变化可以发出多种颜色，绚丽多彩，美观大方，具有很强的观赏性。一般应用于广场夜景、户外公园、停车场、休闲场所、绿化、草坪、庭院、花坛、步行街等照明，给城市的夜晚增添了新的景观。

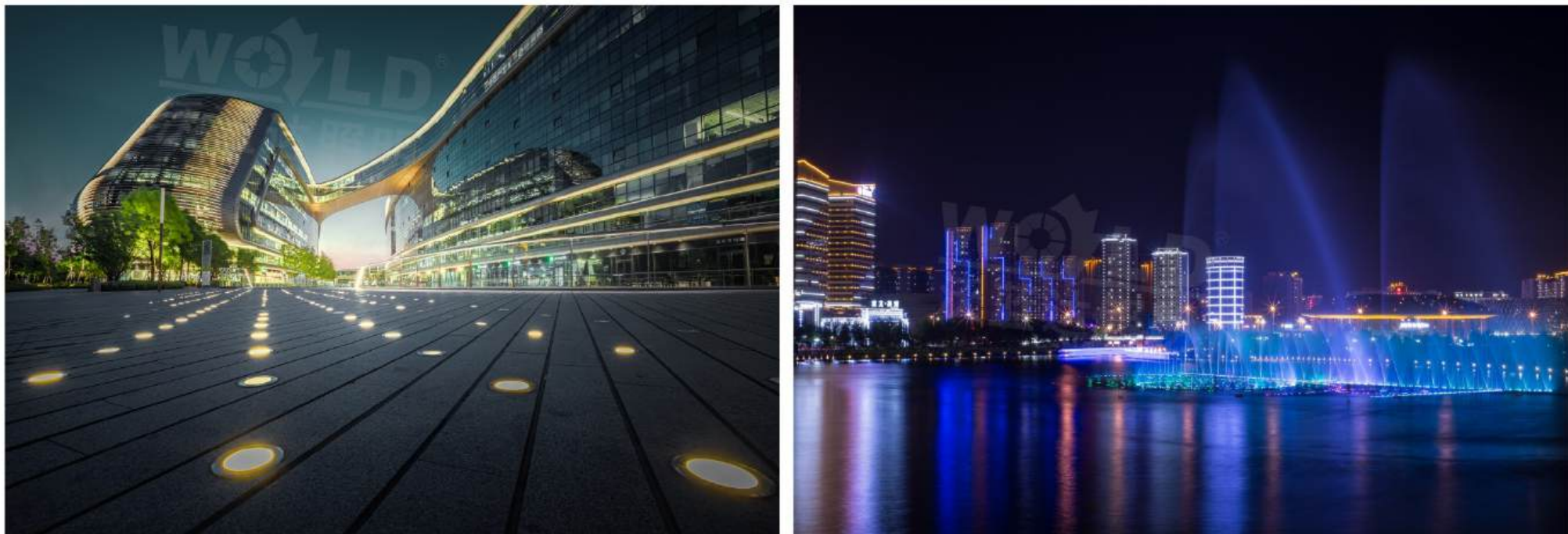

LED户外亮化效果图鉴赏

隧道亮化

可以改善隧道内路面状况，改善隧道内视觉享受，减轻驾驶员疲劳，有利于提高隧道通行能力保证交通安全。



园林亮化

适用于绿色、小区、园林、树木、花草等照明。



工业照明

适用于工厂、矿井、仓库、高棚、石化装置、石油平台、加油站、油泵房、中转站、医药厂、食品厂、面粉厂等生产作业区中使用。





WOYLD
沃蓝达照明



WOYLD
沃蓝达照明

产品特点

- 灯具外壳均采用优质铝材，表面阳极氧化处理，灯体美观精致，散热性能优良；
- 灯体采用钢化玻璃及硅胶密封，内部环氧树脂灌胶，确保灯具卓越的防水性能；
- 低耗高效进口光源，光通量高、显色性强、使用寿命可达5万小时；
- 灯具采用PMMA光学级透镜，可选角度15° 25° 30° 45° 60° 120°；
- 内置恒流AC85V-AC265V宽电压驱动，确保灯具在不同国家、区域或电压不稳时可正常工作；
- 控制方式：单色常亮效果（红、绿、蓝、黄、白、暖白）；内控同步RGB七彩变化；外控同步RGB七彩变化；国际标准DMX512协议控制系统；
- 防水等级：IP65。

适用范围

广泛应用于单体建筑、历史建筑群外墙照明、广告牌照明、绿化景观照明、大楼内光外透照明、室内局部照明、医疗、文化等专门设施照明；酒吧、舞厅等娱乐场所气氛照明等。

Product features

- Pieces of lamps and lanterns shell adopts the high quality aluminum, the surface anodic oxidation treatment, the lamp body beautiful and delicate, excellent heat dissipation performance;
- Lamp body adopts toughened glass and silicon seal, internal epoxy resin glue, to ensure superior waterproof performance of lamps and lanterns;
- Low energy efficient import light source, high luminous flux and color rendering, service life can reach 50000 hours;
- Lamps and lanterns of mixer adopt PMMA optical lens, optional Angle is 15° 25° to 30° 45° to 60° , 120° ;
- Built-in constant-current AC85V pieces - AC265V wide voltage drive, ensure lamps and lanterns in different national, regional or voltage instability when working;
- Control mode: monochrome Chang Liang effect (red, green, blue, yellow, white, warm white); internal control synchronous RGB 7 colour change; External control synchronous RGB 7 colour change; International standard DMX512 protocol control system;
- Waterproof level: Ip65.

Scope of application

Widely used in shopping malls, restaurants, hotels, hotel, household, corridor, office building, sitting room, study, bedroom, balcony, bathroom and other places lighting.

WOYLD
沃蓝达照明

WOYLD
沃蓝达照明

安装使用说明 Installation Instructions for use

- 1、根据现场场景布置好灯的位置，并固定好；
- 2、连接好DMX512信号线和电源线。本产品配有国际标准DMX512信号线，公接为信号输入，母接为信号输出；
- 3、确认安装无误，无电气短路；
- 4、参照操作说明，通电把灯的地址调到控制器对应的通道；
- 5、按照DMX512原理，所连接的灯具超过32个时，要加上对应的中继器；
- 6、如果在安装中出现问题，请咨询本公司技术人员。

- 1, according to the scene layout of the position of the light, and fixed;
- 2, connect the DMX512 signal line and power line. This product with the international standard DMX512 signal lines, bus for signal input, the female connector is a signal output;
- 3, confirm the installation without error, without electrical short circuit;
- 4, with reference to the operating instructions, electric lamp address to the controller corresponding to the channel;
- 5, according to DMX512 principle, the connected lamp exceeds 32, with corresponding repeater;
- 6, if the installation problems, please consult the company's technical staff.

系统图(单色) System map(Monochrome)



说明：每个回路上220V导线上可并接20台，确保金属外壳连接地线。
Note: 220V wire for each loop 20 can be, and then make sure the metal casing connects to the earth.

系统图(全彩) System map(Full color)

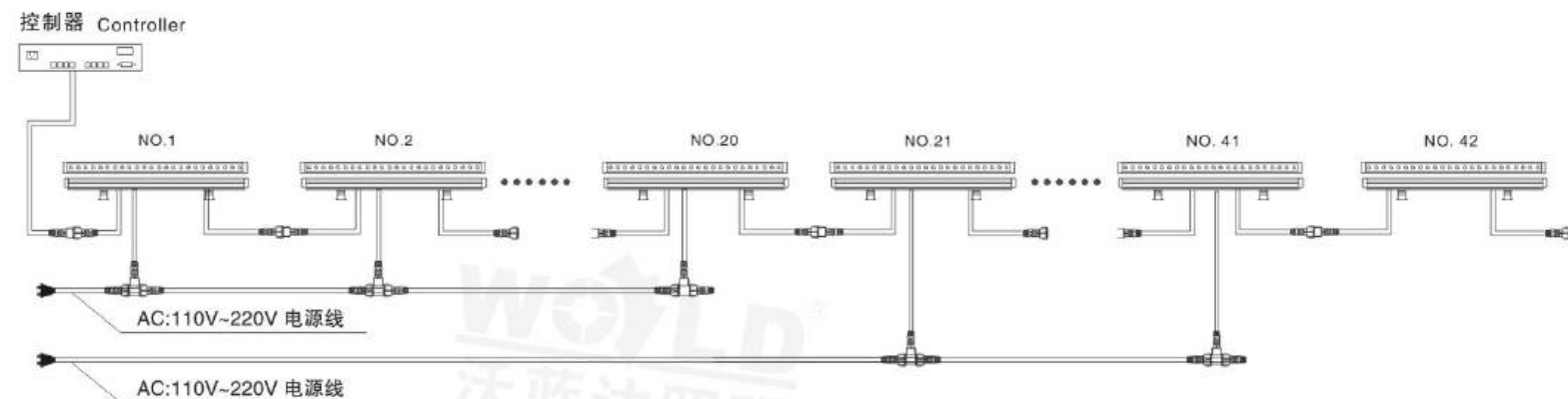

说明：DMX512-1600第一个输出端口可接170台高功率投光灯，每个回路上220V导线上可并接20台，确保金属外壳连接地线。
Note: DMX512-1600 can connect each output port 170 sets of high power lamps for light, 220V wire for each loop 20 can be, and then make sure the metal casing connects to the earth.

产品解析说明 Product analysis instructions

选材·解析

高亮LED芯片
采用高亮芯片，使LED更亮，高功率、低功耗、超高流明，发光更稳定，使用更持久。

高强度钢化玻璃
钢化玻璃采用光学原理设计，经过特殊处理无光斑无花点，光线均外匀，透光率接近100%，具有防爆、防踩压、防水、耐磨保护芯片等性能。

防水端子接线口
采用防水接线端子，防水性能好，防止雨水进入接口导致短路。

高品质铝材灯体
采用高强度超厚精工航空铝材，纯度高、密度大、高硬度不变形，表面经阳极氧化处理，散热好，超强防水，抗腐蚀、抗开裂、抗氧化、防锈、经久耐用不褪色，有效保障灯珠寿命。

金属防水堵头
使用金属防水堵头，双重防水保护灯具，安全实用，寿命长。

光学透镜
采用防水PMMA光学透镜，防水防尘效果更佳，再加以灌胶封装工艺，能很好地将芯片完全的保护在灯罩内，发光更均匀，无光斑无黄晕，透光率高达95%以上。

可调固定支架
采用加厚铝材，双固定脚架，完全参照科学的“黄金三角比例”设计，结构稳定，安全可靠，可180°随意调节灯体角度，满足不同场合的安装需求，不生锈，可拆取式设计，安装更方便。



XQD-WL01

详细参数/SPECIFICATION

光源/Light source:	著名品牌LED光源/famous brand LED light source
常规功率/Conventional power:	18W/24W
灯具尺寸/Lamp size:	L1000xW45xH30mm
工作电压/Voltage:	DC24V/AC220V
灯具寿命/Lamp life:	≥30000H
LED光色/LED color:	R/Y/B/G/W/WW/RGB
色彩效果/Colour effect:	全彩、单色/full colour, monochrome
防护等级/Protection grade:	IP65
环境温度/Environment temperature:	-30℃~+50℃
发光角度/Light angle:	15° /30° /45° /60° /90° /120°



线条尺寸图/Line size chart

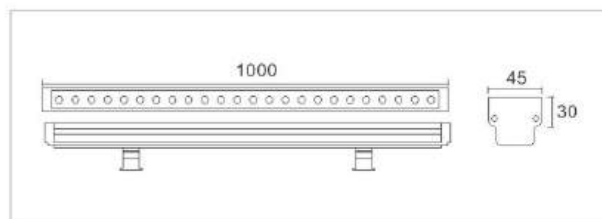

产品细节图/Product detail map



应用场景/Application scenario



表面处理: 抗紫外线聚酯粉, 户外等级喷涂
Surface treatment: anti-ultraviolet polyester powder, spray outdoor level

灯具材质: 铝合金灯体, 表面4mm钢化玻璃面盖, IP65防水, 不锈钢螺丝
Lamp material: aluminum alloy lamp body, surface 4mm toughened glass cover, IP65 waterproof, stainless steel screw

应用场所: 建筑群外墙、广告牌、绿化景观、大楼、酒吧、舞厅等洗墙照明
Application places: Buildings, billboards, landscaping, buildings, bars, dance halls, etc Wash the wall lighting



XQD-WL02

详细参数/SPECIFICATION

光源/Light source:	著名品牌LED光源/famous brand LED light source
常规功率/Conventional power:	24W/36W
灯具尺寸/Lamp size:	L1000xW42xH28mm
工作电压/Voltage:	DC24V/AC220V
灯具寿命/Lamp life:	≥30000H
LED光色/LED color:	R/Y/B/G/W/WW/RGB
色彩效果/Colour effect:	全彩、单色/full colour, monochrome
防护等级/Protection grade:	IP65
环境温度/Environment temperature:	-30℃~+50℃
发光角度/Light angle:	15° /30° /45° /60° /90° /120°



线条尺寸图/Line size chart

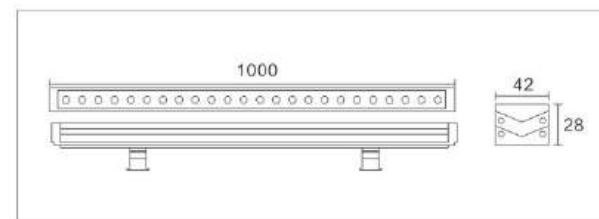

产品细节图/Product detail map



应用场景/Application scenario

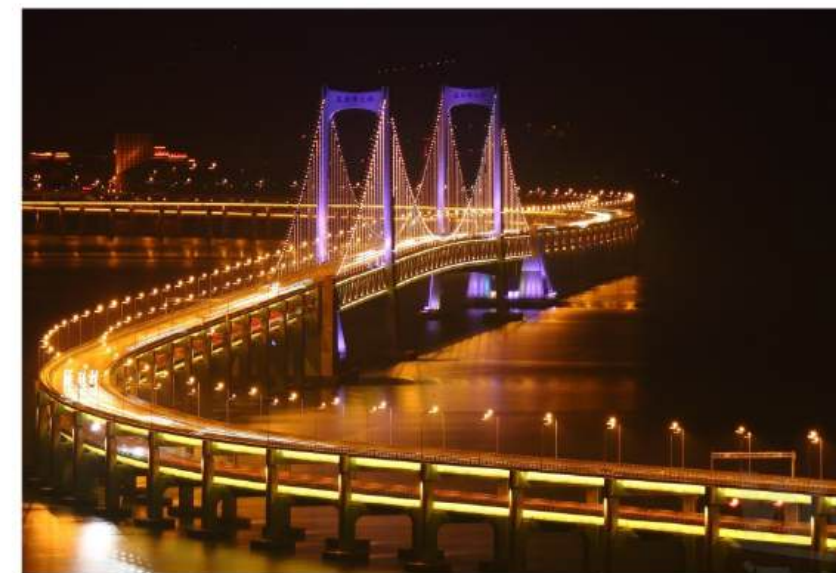

表面处理: 抗紫外线聚酯粉, 户外等级喷涂
Surface treatment: anti-ultraviolet polyester powder, spray outdoor level

灯具材质: 铝合金灯体, 表面4mm钢化玻璃面盖, IP65防水, 不锈钢螺丝
Lamp material: aluminum alloy lamp body, surface 4mm toughened glass cover, IP65 waterproof, stainless steel screw

应用场所: 建筑群外墙、广告牌、绿化景观、大楼、酒吧、舞厅等洗墙照明
Application places: Buildings, billboards, landscaping, buildings, bars, dance halls, etc Wash the wall lighting



XQD-WC03

详细参数/SPECIFICATION

光源/Light source:	著名品牌LED光源/famous brand LED light source
常规功率/Conventional power:	36W
灯具尺寸/Lamp size:	L1000xW23xH32mm/L1000xW23xH48mm
工作电压/Voltage:	DC24V/AC220V
灯具寿命/Lamp life:	>30000H
LED光色/LED color:	R/Y/B/G/W/WW/RGB
色彩效果/Colour effect:	全彩、单色/full colour, monochrome
防护等级/Protection grade:	IP65
环境温度/Environment temperature:	-30℃~+50℃
发光角度/Light angle:	15° /30° /45° /60° /90° /120°



线条尺寸图/Line size chart

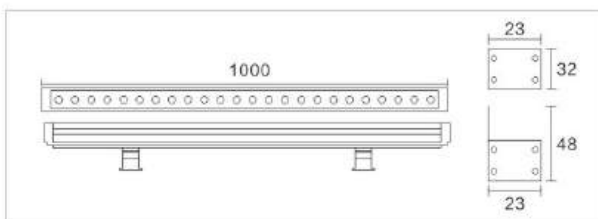

产品细节图/Product detail map



应用场景/Application scenario



表面处理: 抗紫外线聚酯粉, 户外等级喷涂
Surface treatment: anti-ultraviolet polyester powder, spray outdoor level

灯具材质: 铝合金灯体, 表面4mm钢化玻璃面盖, IP65防水, 不锈钢螺丝
Lamp material: aluminum alloy lamp body, surface 4mm toughened glass cover, IP65 waterproof, stainless steel screw

应用场所: 建筑群外墙、广告牌、绿化景观、大楼、酒吧、舞厅等洗墙照明
Application places: Buildings, billboards, landscaping, buildings, bars, dance halls, etc Wash the wall lighting



XQD-WC04

详细参数/SPECIFICATION

光源/Light source:	著名品牌LED光源/famous brand LED light source
常规功率/Conventional power:	18W/24W
灯具尺寸/Lamp size:	L1000xW33xH27mm/L1000xW33xH45mm
工作电压/Voltage:	DC24V/AC220V
灯具寿命/Lamp life:	>30000H
LED光色/LED color:	R/Y/B/G/W/WW/RGB
色彩效果/Colour effect:	全彩、单色/full colour, monochrome
防护等级/Protection grade:	IP65
环境温度/Environment temperature:	-30℃~+50℃
发光角度/Light angle:	15° /30° /45° /60° /90° /120°



线条尺寸图/Line size chart

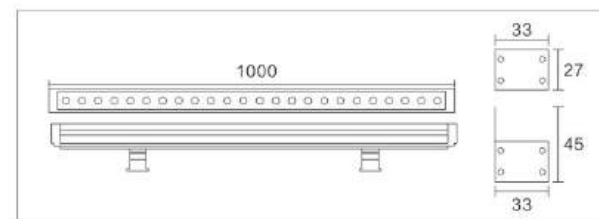

产品细节图/Product detail map



应用场景/Application scenario



表面处理: 抗紫外线聚酯粉, 户外等级喷涂
Surface treatment: anti-ultraviolet polyester powder, spray outdoor level

灯具材质: 铝合金灯体, 表面4mm钢化玻璃面盖, IP65防水, 不锈钢螺丝
Lamp material: aluminum alloy lamp body, surface 4mm toughened glass cover, IP65 waterproof, stainless steel screw

应用场所: 建筑群外墙、广告牌、绿化景观、大楼、酒吧、舞厅等洗墙照明
Application places: Buildings, billboards, landscaping, buildings, bars, dance halls, etc Wash the wall lighting



XQD-WM05

详细参数/SPECIFICATION

光源/Light source:	著名品牌LED光源/famous brand LED light source
常规功率/Conventional power:	24W/36W
灯具尺寸/Lamp size:	L1000xW41xH48mm
工作电压/Voltage:	DC24V/AC220V
灯具寿命/Lamp life:	> 30000H
LED光色/LED color:	R/Y/B/G/W/WW/RGB
色彩效果/Colour effect:	全彩、单色/full colour, monochrome
防护等级/Protection grade:	IP65
环境温度/Environment temperature:	-30℃~+50℃
发光角度/Light angle:	15° /30° /45° /60° /90° /120°



线条尺寸图/Line size chart

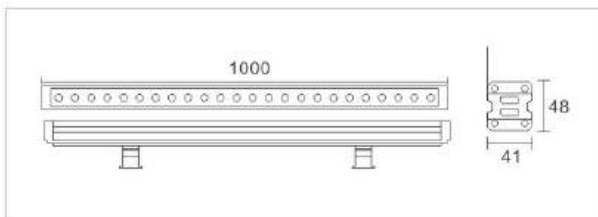

产品细节图/Product detail map



应用场景/Application scenario



表面处理: 抗紫外线聚酯粉, 户外等级喷涂
Surface treatment: anti-ultraviolet polyester powder, spray outdoor level

灯具材质: 铝合金灯体, 表面4mm钢化玻璃面盖, IP65防水, 不锈钢螺丝
Lamp material: aluminum alloy lamp body, surface 4mm toughened glass cover, IP65 waterproof, stainless steel screw

应用场所: 建筑群外墙、广告牌、绿化景观、大楼、酒吧、舞厅等洗墙照明
Application places: Buildings, billboards, landscaping, buildings, bars, dance halls, etc Wash the wall lighting



XQD-SX06

详细参数/SPECIFICATION

光源/Light source:	著名品牌LED光源/famous brand LED light source
常规功率/Conventional power:	24W/36W
灯具尺寸/Lamp size:	L1000xW28xH42mm
工作电压/Voltage:	DC24V/AC220V
灯具寿命/Lamp life:	> 30000H
LED光色/LED color:	R/Y/B/G/W/WW/RGB
色彩效果/Colour effect:	全彩、单色/full colour, monochrome
防护等级/Protection grade:	IP65
环境温度/Environment temperature:	-30℃~+50℃
发光角度/Light angle:	15° /30° /45° /60° /90° /120°



线条尺寸图/Line size chart

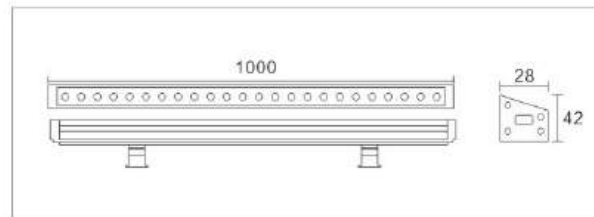

产品细节图/Product detail map



应用场景/Application scenario

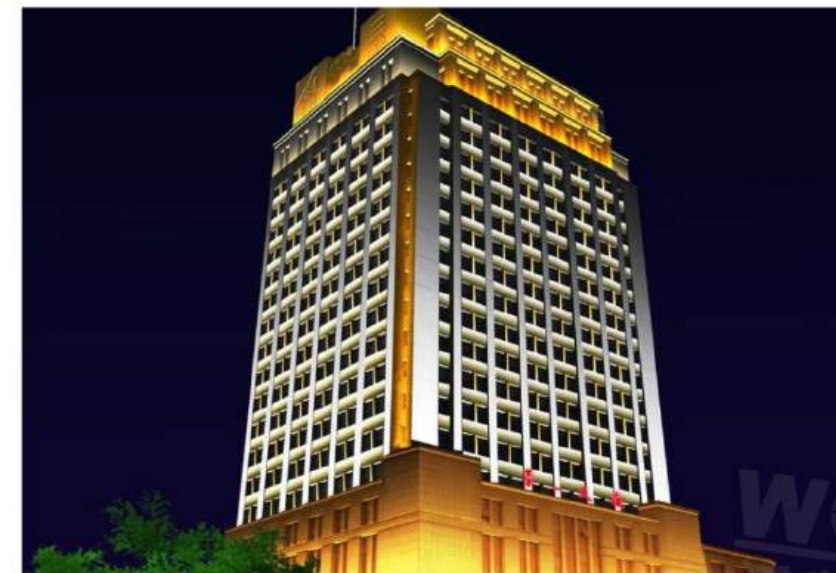

表面处理: 抗紫外线聚酯粉, 户外等级喷涂
Surface treatment: anti-ultraviolet polyester powder, spray outdoor level

灯具材质: 铝合金灯体, 表面4mm钢化玻璃面盖, IP65防水, 不锈钢螺丝
Lamp material: aluminum alloy lamp body, surface 4mm toughened glass cover, IP65 waterproof, stainless steel screw

应用场所: 建筑群外墙、广告牌、绿化景观、大楼、酒吧、舞厅等洗墙照明
Application places: Buildings, billboards, landscaping, buildings, bars, dance halls, etc Wash the wall lighting



XQD-WM07

详细参数/SPECIFICATION

光源/Light source:	著名品牌LED光源/famous brand LED light source
常规功率/Conventional power:	18-24W/24-36W
灯具尺寸/Lamp size:	L980xW36xH30mm/L980xW40xH30mm/ L980xW40xH52mm
工作电压/Voltage:	DC24V/AC220V
灯具寿命/Lamp life:	>30000H
LED光色/LED color:	R/Y/B/G/W/WW/RGB
色彩效果/Colour effect:	全彩、单色/full colour, monochrome
防护等级/Protection grade:	IP65
环境温度/Environment temperature:	-30℃~+50℃
发光角度/Light angle:	15° /30° /45° /60° /90° /120°



线条尺寸图/Line size chart

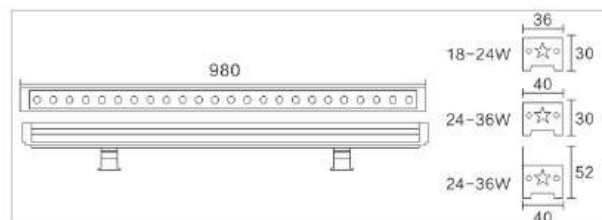

产品细节图/Product detail map



应用场景/Application scenario



表面处理: 抗紫外线聚酯粉, 户外等级喷涂
Surface treatment: anti-ultraviolet polyester powder, spray outdoor level

灯具材质: 铝合金灯体, 表面4mm钢化玻璃面盖, IP65防水, 不锈钢螺丝
Lamp material: aluminum alloy lamp body, surface 4mm toughened glass cover, IP65 waterproof, stainless steel screw

应用场所: 建筑群外墙、广告牌、绿化景观、大楼、酒吧、舞厅等洗墙照明
Application places: Buildings, billboards, landscaping, buildings, bars, dance halls, etc Wash the wall lighting



XQD-WM08

详细参数/SPECIFICATION

光源/Light source:	著名品牌LED光源/famous brand LED light source
常规功率/Conventional power:	18W/24W/36W
灯具尺寸/Lamp size:	L1000xW35xH35mm/L1000xW38xH38mm/ L1000xW41xH41mm
工作电压/Voltage:	DC24V/AC220V
灯具寿命/Lamp life:	>30000H
LED光色/LED color:	R/Y/B/G/W/WW/RGB
色彩效果/Colour effect:	全彩、单色/full colour, monochrome
防护等级/Protection grade:	IP65
环境温度/Environment temperature:	-30℃~+50℃
发光角度/Light angle:	15° /30° /45° /60° /90° /120°



线条尺寸图/Line size chart

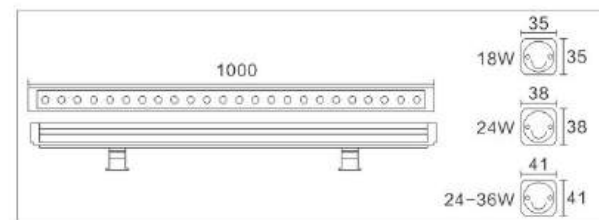

产品细节图/Product detail map



应用场景/Application scenario



表面处理: 抗紫外线聚酯粉, 户外等级喷涂
Surface treatment: anti-ultraviolet polyester powder, spray outdoor level

灯具材质: 铝合金灯体, 表面4mm钢化玻璃面盖, IP65防水, 不锈钢螺丝
Lamp material: aluminum alloy lamp body, surface 4mm toughened glass cover, IP65 waterproof, stainless steel screw

应用场所: 建筑群外墙、广告牌、绿化景观、大楼、酒吧、舞厅等洗墙照明
Application places: Buildings, billboards, landscaping, buildings, bars, dance halls, etc Wash the wall lighting



XQD-WM09

详细参数/SPECIFICATION

光源/Light source:	著名品牌LED光源/famous brand LED light source
常规功率/Conventional power:	18-24W/24-36W
灯具尺寸/Lamp size:	L980xW35xH30mm/L980xW43xH35mm
工作电压/Voltage:	DC24V/AC220V
灯具寿命/Lamp life:	≥30000H
LED光色/LED color:	R/Y/B/G/W/WW/RGB
色彩效果/Colour effect:	全彩、单色/full colour, monochrome
防护等级/Protection grade:	IP65
环境温度/Environment temperature:	-30℃~+50℃
发光角度/Light angle:	15° /30° /45° /60° /90° /120°



线条尺寸图/Line size chart

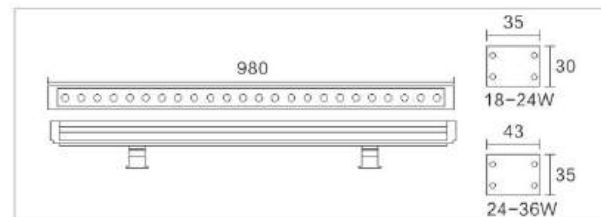

产品细节图/Product detail map



应用场景/Application scenario



表面处理: 抗紫外线聚酯粉, 户外等级喷涂
Surface treatment: anti-ultraviolet polyester powder, spray outdoor level

灯具材质: 铝合金灯体, 表面4mm钢化玻璃面盖, IP65防水, 不锈钢螺丝
Lamp material: aluminum alloy lamp body, surface 4mm toughened glass cover, IP65 waterproof, stainless steel screw

应用场所: 建筑群外墙、广告牌、绿化景观、大楼、酒吧、舞厅等洗墙照明
Application places: Buildings, billboards, landscaping, buildings, bars, dance halls, etc Wash the wall lighting



XQD-WM10

详细参数/SPECIFICATION

光源/Light source:	著名品牌LED光源/famous brand LED light source
常规功率/Conventional power:	48W/72W
灯具尺寸/Lamp size:	L990xW65xH30mm
工作电压/Voltage:	DC24V/AC220V
灯具寿命/Lamp life:	≥30000H
LED光色/LED color:	R/Y/B/G/W/WW/RGB
色彩效果/Colour effect:	全彩、单色/full colour, monochrome
防护等级/Protection grade:	IP65
环境温度/Environment temperature:	-30℃~+50℃
发光角度/Light angle:	15° /30° /45° /60° /90° /120°



线条尺寸图/Line size chart

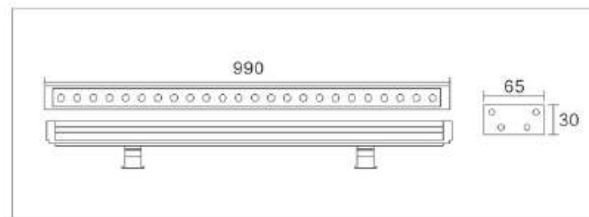

产品细节图/Product detail map



应用场景/Application scenario



表面处理: 抗紫外线聚酯粉, 户外等级喷涂
Surface treatment: anti-ultraviolet polyester powder, spray outdoor level

灯具材质: 铝合金灯体, 表面4mm钢化玻璃面盖, IP65防水, 不锈钢螺丝
Lamp material: aluminum alloy lamp body, surface 4mm toughened glass cover, IP65 waterproof, stainless steel screw

应用场所: 建筑群外墙、广告牌、绿化景观、大楼、酒吧、舞厅等洗墙照明
Application places: Buildings, billboards, landscaping, buildings, bars, dance halls, etc Wash the wall lighting



XQD-SX11

详细参数/SPECIFICATION

光源/Light source:	著名品牌LED光源/famous brand LED light source
常规功率/Conventional power:	48W
灯具尺寸/Lamp size:	L1000xW50xH60mm
工作电压/Voltage:	DC24V/AC220V
灯具寿命/Lamp life:	≥30000H
LED光色/LED color:	R/Y/B/G/W/WW/RGB
色彩效果/Colour effect:	全彩、单色/full colour, monochrome
防护等级/Protection grade:	IP65
环境温度/Environment temperature:	-30℃~+50℃
发光角度/Light angle:	15° /30° /45° /60° /90° /120°



线条尺寸图/Line size chart

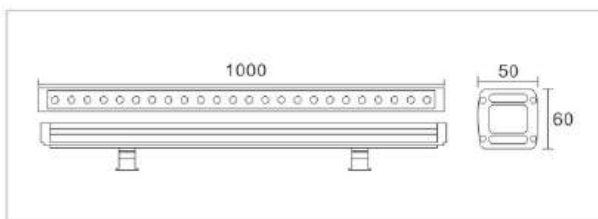

产品细节图/Product detail map



应用场景/Application scenario



表面处理: 抗紫外线聚酯粉, 户外等级喷涂
Surface treatment: anti-ultraviolet polyester powder, spray outdoor level

灯具材质: 铝合金灯体, 表面4mm钢化玻璃面盖, IP65防水, 不锈钢螺丝
Lamp material: aluminum alloy lamp body, surface 4mm toughened glass cover, IP65 waterproof, stainless steel screw

应用场所: 建筑群外墙、广告牌、绿化景观、大楼、酒吧、舞厅等洗墙照明
Application places: Buildings, billboards, landscaping, buildings, bars, dance halls, etc Wash the wall lighting



XQD-SX12

详细参数/SPECIFICATION

光源/Light source:	著名品牌LED光源/famous brand LED light source
常规功率/Conventional power:	36W/48W
灯具尺寸/Lamp size:	L1000xW45xH35mm
工作电压/Voltage:	DC24V/AC220V
灯具寿命/Lamp life:	≥30000H
LED光色/LED color:	R/Y/B/G/W/WW/RGB
色彩效果/Colour effect:	全彩、单色/full colour, monochrome
防护等级/Protection grade:	IP65
环境温度/Environment temperature:	-30℃~+50℃
发光角度/Light angle:	15° /30° /45° /60° /90° /120°



线条尺寸图/Line size chart

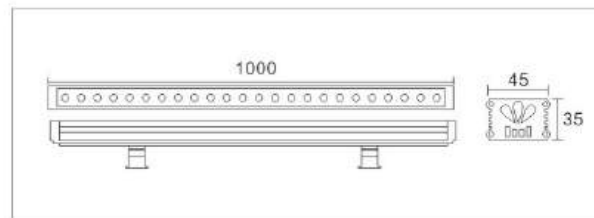

产品细节图/Product detail map



应用场景/Application scenario

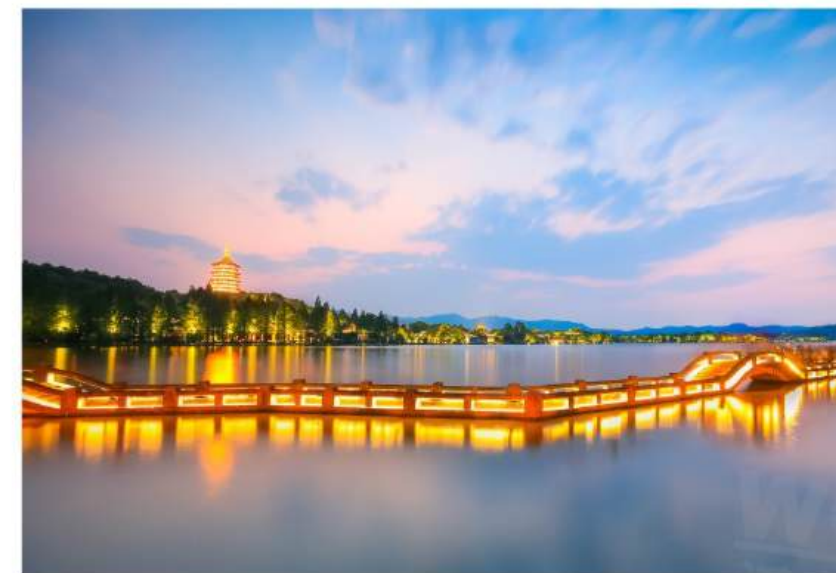

表面处理: 抗紫外线聚酯粉, 户外等级喷涂
Surface treatment: anti-ultraviolet polyester powder, spray outdoor level

灯具材质: 铝合金灯体, 表面4mm钢化玻璃面盖, IP65防水, 不锈钢螺丝
Lamp material: aluminum alloy lamp body, surface 4mm toughened glass cover, IP65 waterproof, stainless steel screw

应用场所: 建筑群外墙、广告牌、绿化景观、大楼、酒吧、舞厅等洗墙照明
Application places: Buildings, billboards, landscaping, buildings, bars, dance halls, etc Wash the wall lighting



XQD-SX13

详细参数/SPECIFICATION

光源/Light source:	著名品牌LED光源/famous brand LED light source
常规功率/Conventional power:	24W
灯具尺寸/Lamp size:	L1000xW39xH33mm
工作电压/Voltage:	DC24V/AC220V
灯具寿命/Lamp life:	≥30000H
LED光色/LED color:	R/Y/B/G/W/WW/RGB
色彩效果/Colour effect:	全彩、单色/full colour, monochrome
防护等级/Protection grade:	IP65
环境温度/Environment temperature:	-30℃~+50℃
发光角度/Light angle:	15° /30° /45° /60° /90° /120°



线条尺寸图/Line size chart

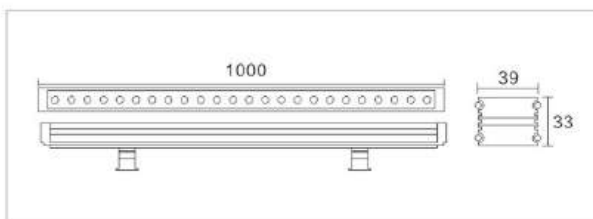

产品细节图/Product detail map



应用场景/Application scenario



表面处理: 抗紫外线聚酯粉, 户外等级喷涂
Surface treatment: anti-ultraviolet polyester powder, spray outdoor level

灯具材质: 铝合金灯体, 表面4mm钢化玻璃面盖, IP65防水, 不锈钢螺丝
Lamp material: aluminum alloy lamp body, surface 4mm toughened glass cover, IP65 waterproof, stainless steel screw

应用场所: 建筑群外墙、广告牌、绿化景观、大楼、酒吧、舞厅等洗墙照明
Application places: Buildings, billboards, landscaping, buildings, bars, dance halls, etc Wash the wall lighting



XQD-WC14

详细参数/SPECIFICATION

光源/Light source:	著名品牌LED光源/famous brand LED light source
常规功率/Conventional power:	18W/24W/36W
灯具尺寸/Lamp size:	L1000xW40xH30mm/L1000xW40xH32mm
工作电压/Voltage:	DC24V/AC220V
灯具寿命/Lamp life:	≥30000H
LED光色/LED color:	R/Y/B/G/W/WW/RGB
色彩效果/Colour effect:	全彩、单色/full colour, monochrome
防护等级/Protection grade:	IP65
环境温度/Environment temperature:	-30℃~+50℃
发光角度/Light angle:	15° /30° /45° /60° /90° /120°



线条尺寸图/Line size chart

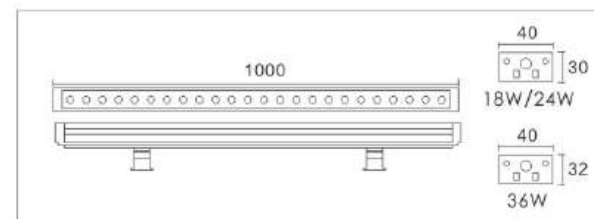

产品细节图/Product detail map



应用场景/Application scenario



表面处理: 抗紫外线聚酯粉, 户外等级喷涂
Surface treatment: anti-ultraviolet polyester powder, spray outdoor level

灯具材质: 铝合金灯体, 表面4mm钢化玻璃面盖, IP65防水, 不锈钢螺丝
Lamp material: aluminum alloy lamp body, surface 4mm toughened glass cover, IP65 waterproof, stainless steel screw

应用场所: 建筑群外墙、广告牌、绿化景观、大楼、酒吧、舞厅等洗墙照明
Application places: Buildings, billboards, landscaping, buildings, bars, dance halls, etc Wash the wall lighting



XQD-GG15

详细参数/SPECIFICATION

光源/Light source:	著名品牌LED光源/famous brand LED light source
常规功率/Conventional power:	18W/24W/36W
工作电压/Voltage:	DC24V/AC220V
灯具寿命/Lamp life:	>30000H
LED光色/LED color:	R/Y/B/G/W/WW/RGB
色彩效果/Colour effect:	全彩、单色/full colour, monochrome
防护等级/Protection grade:	IP65
环境温度/Environment temperature:	-30℃~+50℃
发光角度/Light angle:	15° /30° /45° /60° /90° /120°

线条尺寸图/Line size chart

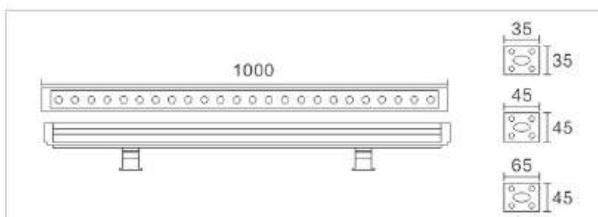

产品细节图/Product detail map



应用场景/Application scenario



应用场所: 建筑群外墙、广告牌、绿化景观、大楼、酒吧、舞厅等洗墙照明
Application places: Buildings, billboards, landscaping, buildings, bars, dance halls, etc Wash the wall lighting



XQD-CH16

详细参数/SPECIFICATION

光源/Light source:	著名品牌LED光源/famous brand LED light source
常规功率/Conventional power:	24-36W
灯具尺寸/Lamp size:	L1002xW45xH26mm
工作电压/Voltage:	DC24V/AC220V
灯具寿命/Lamp life:	>30000H
LED光色/LED color:	R/Y/B/G/W/WW/RGB
色彩效果/Colour effect:	全彩、单色/full colour, monochrome
防护等级/Protection grade:	IP65
环境温度/Environment temperature:	-30℃~+50℃
发光角度/Light angle:	15° /30° /45° /60° /90° /120°

线条尺寸图/Line size chart

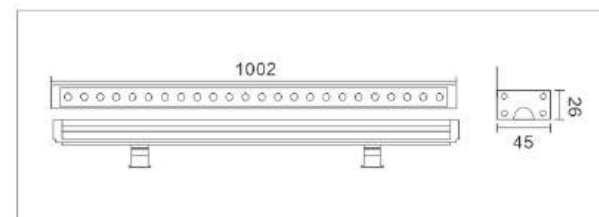

产品细节图/Product detail map



应用场景/Application scenario

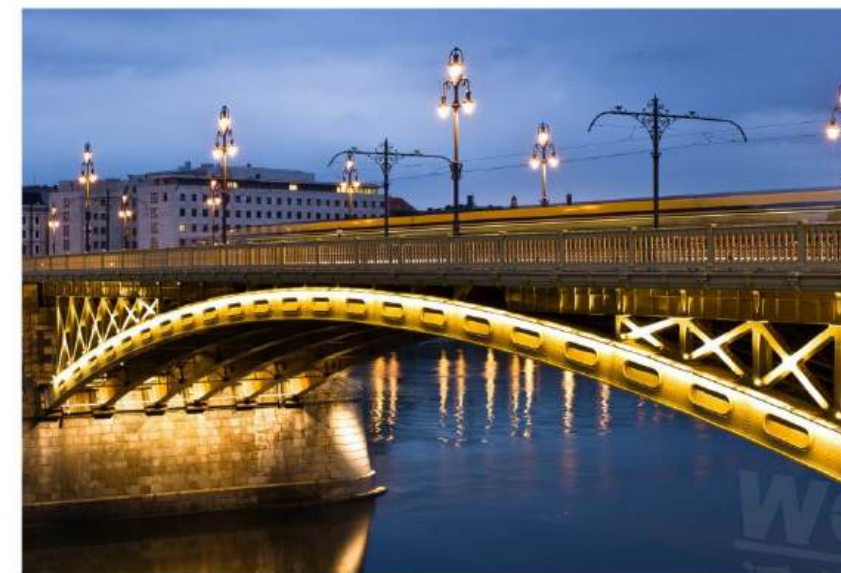

表面处理: 抗紫外线聚酯粉, 户外等级喷涂
Surface treatment: anti-ultraviolet polyester powder, spray outdoor level

灯具材质: 铝合金灯体, 表面4mm钢化玻璃面盖, IP65防水, 不锈钢螺丝
Lamp material: aluminum alloy lamp body, surface 4mm toughened glass cover, IP65 waterproof, stainless steel screw

应用场所: 建筑群外墙、广告牌、绿化景观、大楼、酒吧、舞厅等洗墙照明
Application places: Buildings, billboards, landscaping, buildings, bars, dance halls, etc Wash the wall lighting



XQD-CH17

详细参数/SPECIFICATION

光源/Light source:	著名品牌LED光源/famous brand LED light source
常规功率/Conventional power:	48-72W
灯具尺寸/Lamp size:	L974xW75xH50mm
工作电压/Voltage:	DC24V/AC220V
灯具寿命/Lamp life:	>30000H
LED光色/LED color:	R/Y/B/G/W/WW/RGB
色彩效果/Colour effect:	全彩、单色/full colour, monochrome
防护等级/Protection grade:	IP65
环境温度/Environment temperature:	-30℃~+50℃
发光角度/Light angle:	15° /30° /45° /60° /90° /120°



线条尺寸图/Line size chart

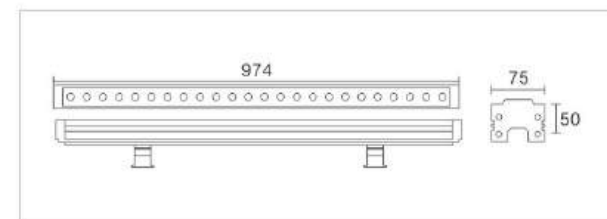

产品细节图/Product detail map



应用场景/Application scenario



表面处理: 抗紫外线聚酯粉, 户外等级喷涂
Surface treatment: anti-ultraviolet polyester powder, spray outdoor level

灯具材质: 铝合金灯体, IP65防水, 不锈钢螺丝
Lamp material: aluminum alloy lamp body, IP65 waterproof, stainless steel screw

应用场所: 建筑群外墙、广告牌、绿化景观、大楼、酒吧、舞厅等洗墙照明
Application places: Buildings, billboards, landscaping, buildings, bars, dance halls, etc Wash the wall lighting



XQD-LL18

详细参数/SPECIFICATION

光源/Light source:	著名品牌LED光源/famous brand LED light source
常规功率/Conventional power:	18W/36W
灯具尺寸/Lamp size:	L1000xW36xH24mm/L1000xW45xH30mm
工作电压/Voltage:	DC24V/AC220V
灯具寿命/Lamp life:	>30000H
LED光色/LED color:	R/Y/B/G/W/WW/RGB
色彩效果/Colour effect:	全彩、单色/full colour, monochrome
防护等级/Protection grade:	IP65
环境温度/Environment temperature:	-30℃~+50℃
发光角度/Light angle:	15° /30° /45°



线条尺寸图/Line size chart

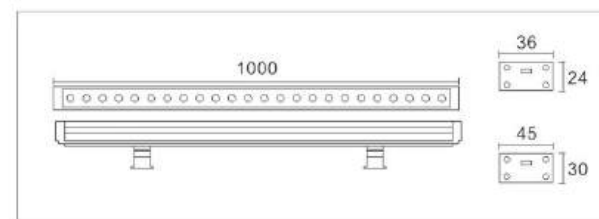

产品细节图/Product detail map



应用场所: 建筑群外墙、广告牌、绿化景观、大楼、酒吧、舞厅等洗墙照明
Application places: Buildings, billboards, landscaping, buildings, bars, dance halls, etc Wash the wall lighting

应用场景/Application scenario





XQD-LL19

详细参数/SPECIFICATION

光源/Light source:	著名品牌LED光源/famous brand LED light source
常规功率/Conventional power:	18W/24W/36W
灯具尺寸/Lamp size:	L1000xW36xH50mm
工作电压/Voltage:	DC24V/AC220V
灯具寿命/Lamp life:	≥30000H
LED光色/LED color:	R/Y/B/G/W/WW/RGB
色彩效果/Colour effect:	全彩、单色/full colour, monochrome
防护等级/Protection grade:	IP65
环境温度/Environment temperature:	-30℃~+50℃
发光角度/Light angle:	15° /30° /45°

线条尺寸图/Line size chart

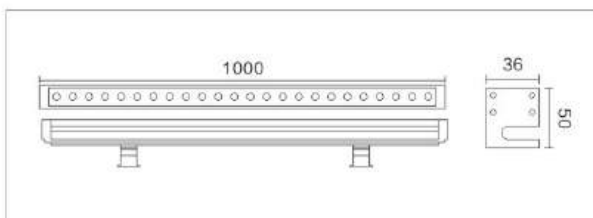

产品细节图/Product detail map



应用场景/Application scenario



表面处理: 抗紫外线聚酯粉, 户外等级喷涂
Surface treatment: anti-ultraviolet polyester powder, spray outdoor level

灯具材质: 铝合金灯体, 表面4mm钢化玻璃面盖, IP65防水, 不锈钢螺丝
Lamp material: aluminum alloy lamp body, surface 4mm toughened glass cover, IP65 waterproof, stainless steel screw

应用场所: 建筑群外墙、广告牌、绿化景观、大楼、酒吧、舞厅等洗墙照明
Application places: Buildings, billboards, landscaping, buildings, bars, dance halls, etc Wash the wall lighting



XQD-020

详细参数/SPECIFICATION

光源/Light source:	著名品牌LED光源/famous brand LED light source
常规功率/Conventional power:	36W/48W/60W
灯具尺寸/Lamp size:	L1000xW80xH85mm
工作电压/Voltage:	DC24V/AC220V
灯具寿命/Lamp life:	≥30000H
LED光色/LED color:	R/Y/B/G/W/WW/RGB
色彩效果/Colour effect:	全彩、单色/full colour, monochrome
防护等级/Protection grade:	IP65
环境温度/Environment temperature:	-30℃~+50℃
发光角度/Light angle:	15° /30° /45° /60° /90° /120°

线条尺寸图/Line size chart

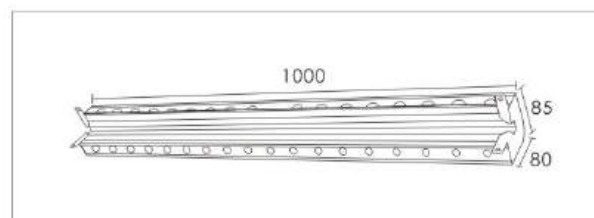

应用场景/Application scenario



表面处理: 抗紫外线聚酯粉, 户外等级喷涂
Surface treatment: anti-ultraviolet polyester powder, spray outdoor level

灯具材质: 铝合金灯体, 表面4mm钢化玻璃面盖, IP65防水, 不锈钢螺丝
Lamp material: aluminum alloy lamp body, surface 4mm toughened glass cover, IP65 waterproof, stainless steel screw

应用场所: 建筑群外墙、广告牌、绿化景观、大楼、酒吧、舞厅等洗墙照明
Application places: Buildings, billboards, landscaping, buildings, bars, dance halls, etc Wash the wall lighting

LED WASH WALL LAMP SERIES
LED洗墙灯系列



XQD-021

详细参数/SPECIFICATION

光源Light source:
著名品牌LED光源
常规功率Conventional power:
18W/24W
灯具尺寸/Lamp size:
L1000xW42xH30mm
工作电压/Voltage:
DC24V/AC220V
灯具寿命/Lamp life:
>30000H
LED光色/LED color:
R/Y/B/G/W/WW/RGB
色彩效果/Colour effect:
全彩、单色/full colour, monochrome
防护等级/Protection grade:
IP65
环境温度/Environment temperature:
-30℃~+50℃
发光角度/Light angle:
5° /15° /30° /60° /90° /120°

线条尺寸图/Line size chart

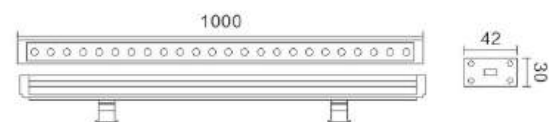

XQD-022

详细参数/SPECIFICATION

光源Light source:
著名品牌LED光源
常规功率Conventional power:
12W/18W/24W
灯具尺寸/Lamp size:
L1000xW40xH30mm
工作电压/Voltage:
DC24V/AC220V
灯具寿命/Lamp life:
>30000H
LED光色/LED color:
R/Y/B/G/W/WW/RGB
色彩效果/Colour effect:
全彩、单色/full colour, monochrome
防护等级/Protection grade:
IP65
环境温度/Environment temperature:
-30℃~+50℃
发光角度/Light angle:
5° /15° /30° /60° /90°

线条尺寸图/Line size chart

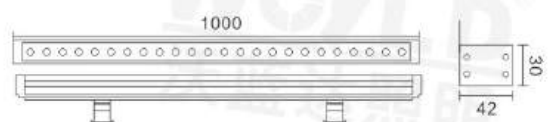

XQD-023

详细参数/SPECIFICATION

光源Light source:
著名品牌LED光源
常规功率Conventional power:
18W/24W/36W
灯具尺寸/Lamp size:
L1000xW46xH28mm
工作电压/Voltage:
DC24V/AC220V
灯具寿命/Lamp life:
>30000H
LED光色/LED color:
R/Y/B/G/W/WW/RGB
色彩效果/Colour effect:
全彩、单色/full colour, monochrome
防护等级/Protection grade:
IP65
环境温度/Environment temperature:
-30℃~+50℃
发光角度/Light angle:
5° /15° /30° /60° /90°

线条尺寸图/Line size chart

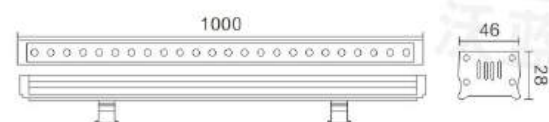

XQD-024

详细参数/SPECIFICATION

光源Light source:
著名品牌LED光源
常规功率Conventional power:
18W/24W
灯具尺寸/Lamp size:
L1000xW40xH37mm
工作电压/Voltage:
DC24V/AC220V
灯具寿命/Lamp life:
>30000H
LED光色/LED color:
R/Y/B/G/W/WW/RGB
色彩效果/Colour effect:
全彩、单色/full colour, monochrome
防护等级/Protection grade:
IP65
环境温度/Environment temperature:
-30℃~+50℃
发光角度/Light angle:
5° /15° /30° /45° /60° /90° /120°

线条尺寸图/Line size chart

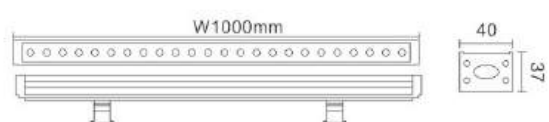

LED WASH WALL LAMP SERIES
LED洗墙灯系列



XQD-025

详细参数/SPECIFICATION

光源Light source:
著名品牌LED光源
常规功率Conventional power:
18W/24W
灯具尺寸/Lamp size:
L1000xW43xH26mm
工作电压/Voltage:
DC24V/AC220V
灯具寿命/Lamp life:
>30000H
LED光色/LED color:
R/Y/B/G/W/WW/RGB
色彩效果/Colour effect:
全彩、单色/full colour, monochrome
防护等级/Protection grade:
IP65
环境温度/Environment temperature:
-30℃~+50℃
发光角度/Light angle:
5° /15° /30° /60° /90° /120°

线条尺寸图/Line size chart

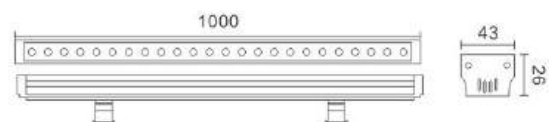

XQD-026

详细参数/SPECIFICATION

光源Light source:
著名品牌LED光源
常规功率Conventional power:
18W/24W
灯具尺寸/Lamp size:
L1000xW40xH25mm
工作电压/Voltage:
DC24V/AC220V
灯具寿命/Lamp life:
>30000H
LED光色/LED color:
R/Y/B/G/W/WW/RGB
色彩效果/Colour effect:
全彩、单色/full colour, monochrome
防护等级/Protection grade:
IP65
环境温度/Environment temperature:
-30℃~+50℃
发光角度/Light angle:
5° /15° /30° /60° /90° /120°

线条尺寸图/Line size chart

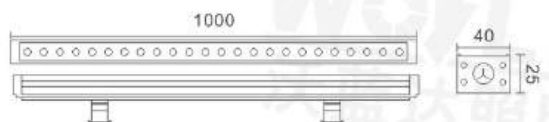

XQD-BT27

详细参数/SPECIFICATION

光源Light source:
著名品牌LED光源
常规功率Conventional power:
18W/24W
灯具尺寸/Lamp size:
L1000xW50xH35mm
工作电压/Voltage:
DC24V/AC220V
灯具寿命/Lamp life:
>30000H
LED光色/LED color:
R/Y/B/G/W/WW/RGB
色彩效果/Colour effect:
全彩、单色/full colour, monochrome
防护等级/Protection grade:
IP65
环境温度/Environment temperature:
-30℃~+50℃
发光角度/Light angle:
5° /15° /30° /60° /90° /120°

线条尺寸图/Line size chart

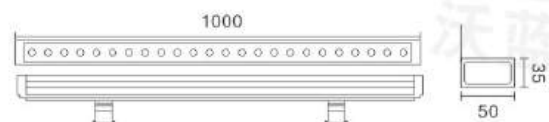

XQD-028

详细参数/SPECIFICATION

光源Light source:
著名品牌LED光源
常规功率Conventional power:
24W/36W/48W/54W/72W
灯具尺寸/Lamp size:
L1000xW90xH80mm
工作电压/Voltage:
DC24V/AC220V
灯具寿命/Lamp life:
>30000H
LED光色/LED color:
R/Y/B/G/W/WW/RGB
色彩效果/Colour effect:
全彩、单色/full colour, monochrome
防护等级/Protection grade:
IP65
环境温度/Environment temperature:
-30℃~+50℃
发光角度/Light angle:
5° /15° /30° /60° /90° /120°

线条尺寸图/Line size chart

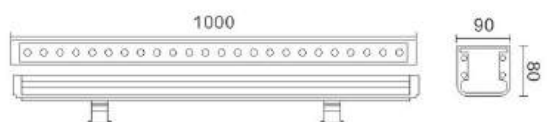

LED WASH WALL LAMP SERIES
LED洗墙灯系列



XQD-WL29

详细参数/SPECIFICATION

光源Light source:
著名品牌LED光源
常规功率Conventional power:
18W/24W
灯具尺寸/Lamp size:
L1000xW40xH28mm
工作电压/Voltage:
DC24V/AC220V
灯具寿命/Lamp life:
>30000H
LED光色/LED color:
R/Y/B/G/W/WW/RGB
色彩效果/Colour effect:
全彩、单色/full colour, monochrome
防护等级/Protection grade:
IP65
环境温度/Environment temperature:
-30℃~+50℃
发光角度/Light angle:
15°/30°/45°/60°/90°/120°

线条尺寸图/Line size chart

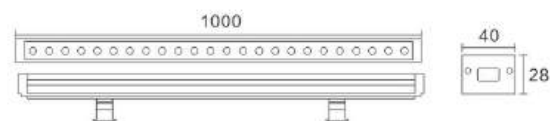

XQD-WL30

详细参数/SPECIFICATION

光源Light source:
著名品牌LED光源
常规功率Conventional power:
18W/24W
灯具尺寸/Lamp size:
L1000xW36xH25mm
工作电压/Voltage:
DC24V/AC220V
灯具寿命/Lamp life:
>30000H
LED光色/LED color:
R/Y/B/G/W/WW/RGB
色彩效果/Colour effect:
全彩、单色/full colour, monochrome
防护等级/Protection grade:
IP65
环境温度/Environment temperature:
-30℃~+50℃
发光角度/Light angle:
15°/30°/45°/60°/90°/120°

线条尺寸图/Line size chart

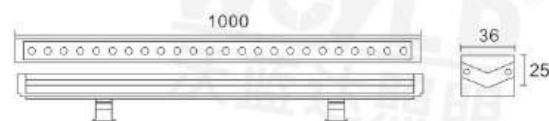

XQD-SX31

详细参数/SPECIFICATION

光源Light source:
著名品牌LED光源
常规功率Conventional power:
18W
灯具尺寸/Lamp size:
L1000xW35xH50mm
工作电压/Voltage:
DC24V/AC220V
灯具寿命/Lamp life:
>30000H
LED光色/LED color:
R/Y/B/G/W/WW/RGB
色彩效果/Colour effect:
全彩、单色/full colour, monochrome
防护等级/Protection grade:
IP65
环境温度/Environment temperature:
-30℃~+50℃
发光角度/Light angle:
15°/30°/45°/60°/90°/120°

线条尺寸图/Line size chart

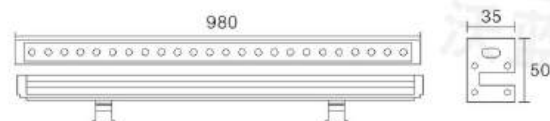

XQD-SH32

详细参数/SPECIFICATION

光源Light source:
著名品牌LED光源
常规功率Conventional power:
18W/24W/36W/48W
灯具尺寸/Lamp size:
L1000xW45xH60mm
工作电压/Voltage:
DC24V/AC220V
灯具寿命/Lamp life:
>30000H
LED光色/LED color:
R/Y/B/G/W/WW/RGB
色彩效果/Colour effect:
全彩、单色/full colour, monochrome
防护等级/Protection grade:
IP65
环境温度/Environment temperature:
-30℃~+50℃
发光角度/Light angle:
5°/15°/30°/60°/90°

线条尺寸图/Line size chart

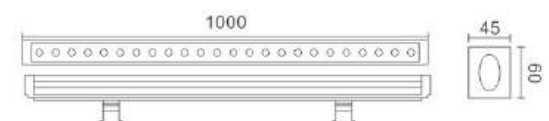

LED WASH WALL LAMP SERIES
LED洗墙灯系列



XQD-CH33

详细参数/SPECIFICATION

光源Light source:
著名品牌LED光源
常规功率Conventional power:
18-36W
灯具尺寸/Lamp size:
L1000xW37xH35mm
工作电压/Voltage:
DC24V/AC220V
灯具寿命/Lamp life:
>30000H
LED光色/LED color:
R/Y/B/G/W/WW/RGB
色彩效果/Colour effect:
全彩、单色/full colour, monochrome
防护等级/Protection grade:
IP65
环境温度/Environment temperature:
-30℃~+50℃
发光角度/Light angle:
15°/30°/45°/60°/90°/120°

线条尺寸图/Line size chart

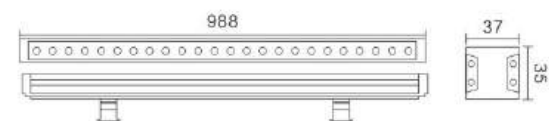

XQD-CH34

详细参数/SPECIFICATION

光源Light source:
著名品牌LED光源
常规功率Conventional power:
18W/24W/36W
灯具尺寸/Lamp size:
L984xW38xH32mm/L984xW45xH32mm
工作电压/Voltage:
DC24V/AC220V
灯具寿命/Lamp life:
>30000H
LED光色/LED color:
R/Y/B/G/W/WW/RGB
色彩效果/Colour effect:
全彩、单色/full colour, monochrome
防护等级/Protection grade:
IP65
环境温度/Environment temperature:
-30℃~+50℃
发光角度/Light angle:
15°/30°/45°/60°/90°/120°

线条尺寸图/Line size chart

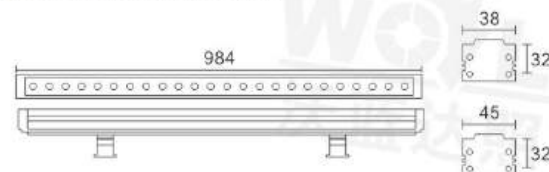

XQD-LL35

详细参数/SPECIFICATION

光源Light source:
著名品牌LED光源
常规功率Conventional power:
18W/24W/36W/48W
灯具尺寸/Lamp size:
L1000xW36xH27mm
工作电压/Voltage:
DC24V/AC220V
灯具寿命/Lamp life:
>30000H
LED光色/LED color:
R/Y/B/G/W/WW/RGB
色彩效果/Colour effect:
全彩、单色/full colour, monochrome
防护等级/Protection grade:
IP65
环境温度/Environment temperature:
-30℃~+50℃
发光角度/Light angle:
15°/30°/45°

线条尺寸图/Line size chart

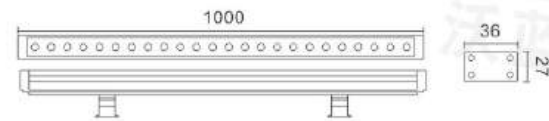

XQD-036

详细参数/SPECIFICATION

光源Light source:
著名品牌LED光源
常规功率Conventional power:
18W/24W/36W
灯具尺寸/Lamp size:
L1000xW45xH80mm
工作电压/Voltage:
DC24V/AC220V
灯具寿命/Lamp life:
>30000H
LED光色/LED color:
R/Y/B/G/W/WW/RGB
色彩效果/Colour effect:
全彩、单色/full colour, monochrome
防护等级/Protection grade:
IP65
环境温度/Environment temperature:
-30℃~+50℃
发光角度/Light angle:
5°/15°/30°/60°/90°

线条尺寸图/Line size chart

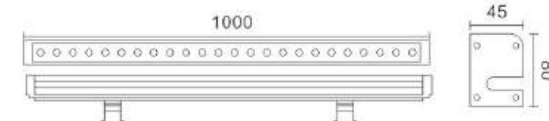



产品特点

- 灯具外壳均采用优质铝材，表面阳极氧化处理，灯体美观精致，散热性能优良；
- 灯体采用钢化玻璃及硅胶密封，内部环氧树脂灌胶，确保灯具卓越的防水性能；
- 低耗高效进口光源，光通量高、显色性强、使用寿命可达到5万小时；
- 内置恒流AC85V-AC265V宽电压驱动，确保灯具在不同国家、区域或电压不稳时可正常工作；
- 控制方式：单色常亮效果（红、绿、蓝、黄、白、暖白）；内控同步RGB七彩变化；外控同步RGB七彩变化；国际标准DMX512协议控制系统；

适用范围

广泛应用于单体建筑、历史建筑群外墙、广告牌、绿化景观、大楼等轮廓装饰照明。

Product features

- Pieces of lamps and lanterns shell adopts the high quality aluminum, the surface anodic oxidation treatment, the lamp body beautiful and delicate, excellent heat dissipation performance;
- Lamp body adopts toughened glass and silicon seal, internal epoxy resin glue, to ensure superior waterproof performance of lamps and lanterns;
- Low energy efficient import light source, high luminous flux and color rendering, service life can reach 50000 hours;
- Built-in constant-current AC85V pieces - AC265V wide voltage drive, ensure lamps and lanterns in different national, regional or voltage instability when working;
- Control mode: monochrome Chang Liang effect (red, green, blue, yellow, white, warm white); internal control synchronous RGB 7 colour change; External control synchronous RGB 7 colour change; International standard DMX512 protocol control system;

Scope of application

Widely used in the monomer architecture, historical buildings exterior wall, billboards, landscape, building contour decorative lighting, etc.



XTD-WL01

详细参数/SPECIFICATION

光源/Light source:	著名品牌LED光源/famous brand LED light source
常规功率/Conventional power:	12W
灯具尺寸/Lamp size:	L1000xW30xH30mm
工作电压/Voltage:	DC24V
灯具寿命/Lamp life:	≥30000H
LED光色/LED color:	R/Y/B/G/W/WW/RGB
色彩效果/Colour effect:	全彩、单色/full colour, monochrome
防护等级/Protection grade:	IP65
环境温度/Environment temperature:	-30℃~+50℃
发光角度/Light angle:	60° /120°



线条尺寸图/Line size chart

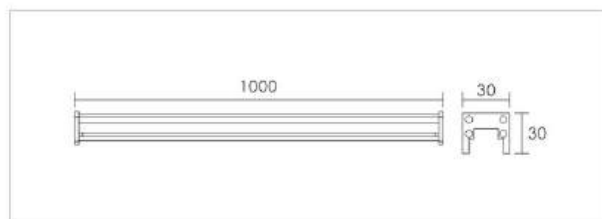

产品细节图/Product detail map



应用场景/Application scenario



表面处理: 表面经阳极氧化、户外等级喷涂处理
Surface treatment: The surface is sprayed by anodic oxidation and outdoor grade

灯具材质: 采用优质航空铝材
Lamp material: Use high quality aviation aluminum to form

应用场所: 建筑群外墙、广告牌、绿化景观、大楼、酒吧、舞厅等外墙照明
Application places: Buildings, billboards, landscaping, buildings, bars, dance halls, etc exterior lighting



XTD-WL02

详细参数/SPECIFICATION

光源/Light source:	著名品牌LED光源/famous brand LED light source
常规功率/Conventional power:	12W
灯具尺寸/Lamp size:	L1000xW30xH30mm
工作电压/Voltage:	DC24V
灯具寿命/Lamp life:	≥30000H
LED光色/LED color:	R/Y/B/G/W/WW/RGB
色彩效果/Colour effect:	全彩、单色/full colour, monochrome
防护等级/Protection grade:	IP65
环境温度/Environment temperature:	-30℃~+50℃
发光角度/Light angle:	60° /120°



线条尺寸图/Line size chart

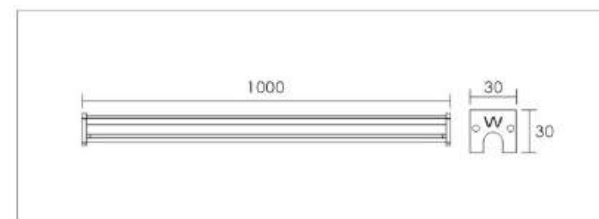

产品细节图/Product detail map



应用场景/Application scenario



表面处理: 表面经阳极氧化、户外等级喷涂处理
Surface treatment: The surface is sprayed by anodic oxidation and outdoor grade

灯具材质: 采用优质航空铝材、钢化玻璃面盖
Lamp material: Use high quality aviation aluminum to form, Tempered glass cover

应用场所: 建筑群外墙、广告牌、绿化景观、大楼、酒吧、舞厅等外墙照明
Application places: Buildings, billboards, landscaping, buildings, bars, dance halls, etc exterior lighting



XTD-WL03

详细参数/SPECIFICATION

光源/Light source:	著名品牌LED光源/famous brand LED light source
常规功率/Conventional power:	12W
灯具尺寸/Lamp size:	L1000xW28xH32mm
工作电压/Voltage:	DC24V
灯具寿命/Lamp life:	>30000H
LED光色/LED color:	R/Y/B/G/W/WW/RGB
色彩效果/Colour effect:	全彩、单色/full colour, monochrome
防护等级/Protection grade:	IP65
环境温度/Environment temperature:	-30℃~+50℃
发光角度/Light angle:	60° /120°



线条尺寸图/Line size chart

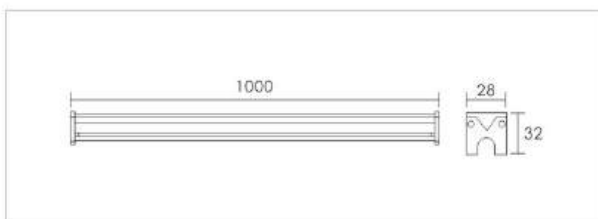

产品细节图/Product detail map



应用场景/Application scenario



表面处理: 表面经阳极氧化、户外等级喷涂处理
Surface treatment: The surface is sprayed by anodic oxidation and outdoor grade

灯具材质: 采用优质航空铝材、钢化玻璃面盖
Lamp material: Use high quality aviation aluminum to form, Tempered glass cover

应用场所: 建筑群外墙、广告牌、绿化景观、大楼、酒吧、舞厅等外墙照明
Application places: Buildings, billboards, landscaping, buildings, bars, dance halls, etc exterior lighting



XTD-WL04

详细参数/SPECIFICATION

光源/Light source:	著名品牌LED光源/famous brand LED light source
常规功率/Conventional power:	12W
灯具尺寸/Lamp size:	L1000xW30xH28mm
工作电压/Voltage:	DC24V
灯具寿命/Lamp life:	>30000H
LED光色/LED color:	R/Y/B/G/W/WW/RGB
色彩效果/Colour effect:	全彩、单色/full colour, monochrome
防护等级/Protection grade:	IP65
环境温度/Environment temperature:	-30℃~+50℃
发光角度/Light angle:	60° /120°



线条尺寸图/Line size chart

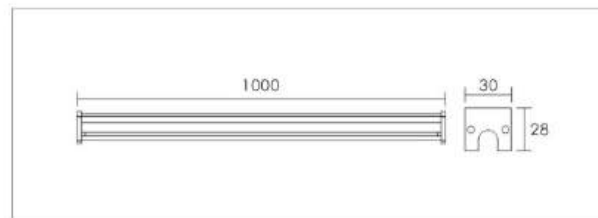

产品细节图/Product detail map



应用场景/Application scenario



表面处理: 表面经阳极氧化、户外等级喷涂处理
Surface treatment: The surface is sprayed by anodic oxidation and outdoor grade

灯具材质: 采用优质航空铝材、钢化玻璃面盖
Lamp material: Use high quality aviation aluminum to form, Tempered glass cover

应用场所: 建筑群外墙、广告牌、绿化景观、大楼、酒吧、舞厅等外墙照明
Application places: Buildings, billboards, landscaping, buildings, bars, dance halls, etc exterior lighting



XTD-WC05

详细参数/SPECIFICATION

光源/Light source:	著名品牌LED光源/famous brand LED light source
常规功率/Conventional power:	12W
灯具尺寸/Lamp size:	L1000xW23xH35mm/L1000xW23xH50mm
工作电压/Voltage:	DC24V
灯具寿命/Lamp life:	>30000H
LED光色/LED color:	R/Y/B/G/W/WW/RGB
色彩效果/Colour effect:	全彩、单色/full colour, monochrome
防护等级/Protection grade:	IP65
环境温度/Environment temperature:	-30℃~+50℃
发光角度/Light angle:	60° /120°



线条尺寸图/Line size chart

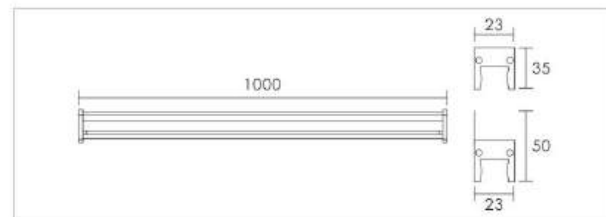

产品细节图/Product detail map



应用场景/Application scenario



表面处理: 表面经阳极氧化、户外等级喷涂处理
Surface treatment: The surface is sprayed by anodic oxidation and outdoor grade

灯具材质: 采用优质航空铝材
Lamp material: Use high quality aviation aluminum to form

应用场所: 建筑群外墙、广告牌、绿化景观、大楼、酒吧、舞厅等外墙照明
Application places: Buildings, billboards, landscaping, buildings, bars, dance halls, etc exterior lighting



XTD-WC06

详细参数/SPECIFICATION

光源/Light source:	著名品牌LED光源/famous brand LED light source
常规功率/Conventional power:	12W
灯具尺寸/Lamp size:	L1000xW23xH35mm/L1000xW23xH50mm
工作电压/Voltage:	DC24V
灯具寿命/Lamp life:	>30000H
LED光色/LED color:	R/Y/B/G/W/WW/RGB
色彩效果/Colour effect:	全彩、单色/full colour, monochrome
防护等级/Protection grade:	IP65
环境温度/Environment temperature:	-30℃~+50℃
发光角度/Light angle:	60° /120°



线条尺寸图/Line size chart

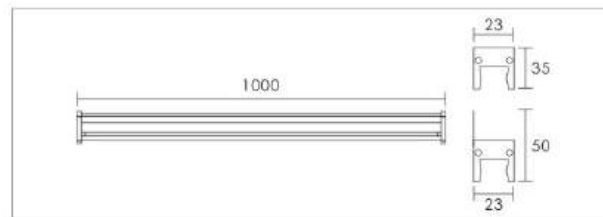

产品细节图/Product detail map



应用场景/Application scenario

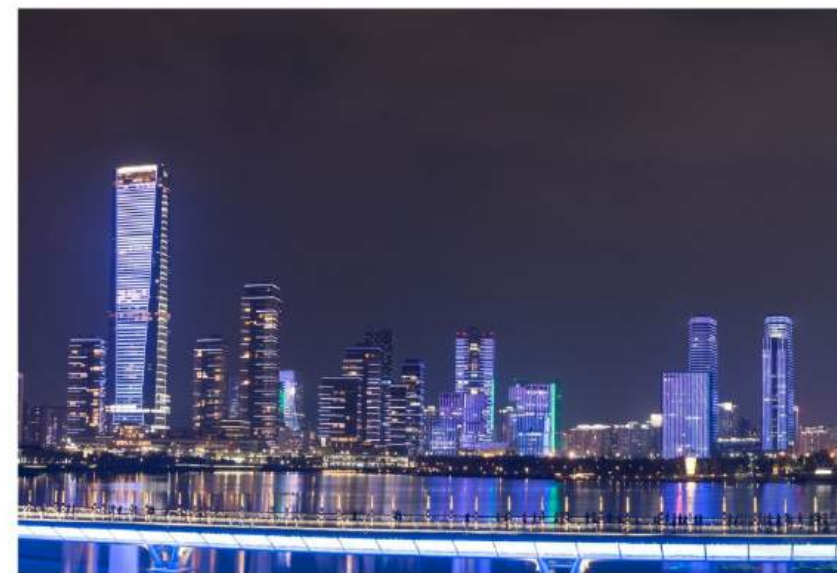

表面处理: 表面经阳极氧化、户外等级喷涂处理
Surface treatment: The surface is sprayed by anodic oxidation and outdoor grade

灯具材质: 采用优质航空铝材
Lamp material: Use high quality aviation aluminum to form

应用场所: 建筑群外墙、广告牌、绿化景观、大楼、酒吧、舞厅等外墙照明
Application places: Buildings, billboards, landscaping, buildings, bars, dance halls, etc exterior lighting



XTD-SX07

详细参数/SPECIFICATION

光源/Light source:	著名品牌LED光源/famous brand LED light source
常规功率/Conventional power:	12W
灯具尺寸/Lamp size:	L1000xW28xH41mm
工作电压/Voltage:	DC24V
灯具寿命/Lamp life:	>30000H
LED光色/LED color:	R/Y/B/G/W/WW/RGB
色彩效果/Colour effect:	全彩、单色/full colour, monochrome
防护等级/Protection grade:	IP65
环境温度/Environment temperature:	-30℃~+50℃
发光角度/Light angle:	60° /120°



线条尺寸图/Line size chart

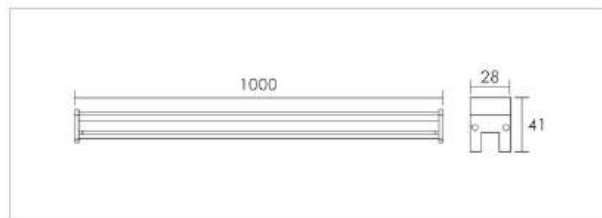

产品细节图/Product detail map



应用场景/Application scenario



表面处理: 表面经阳极氧化、户外等级喷涂处理
Surface treatment: The surface is sprayed by anodic oxidation and outdoor grade

灯具材质: 采用优质航空铝材, 亚克力面罩
Lamp material: Use high quality aviation aluminum to form, Acrylic mask

应用场所: 建筑群外墙、广告牌、绿化景观、大楼、酒吧、舞厅等外墙照明
Application places: Buildings, billboards, landscaping, buildings, bars, dance halls, etc exterior lighting



XTD-GG08

详细参数/SPECIFICATION

光源/Light source:	著名品牌LED光源/famous brand LED light source
常规功率/Conventional power:	10-12W
灯具尺寸/Lamp size:	L1000xW24xH21mm/L1000xW30xH30mm
工作电压/Voltage:	DC24V
灯具寿命/Lamp life:	>30000H
LED光色/LED color:	R/Y/B/G/W/WW/RGB
色彩效果/Colour effect:	全彩、单色/full colour, monochrome
防护等级/Protection grade:	IP65
环境温度/Environment temperature:	-30℃~+50℃
发光角度/Light angle:	60° /120°



线条尺寸图/Line size chart

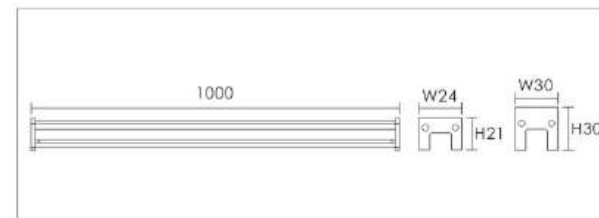

产品细节图/Product detail map

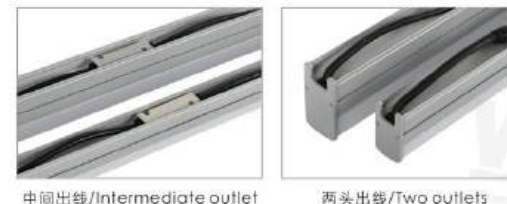

表面处理: 表面经阳极氧化、户外等级喷涂处理
Surface treatment: The surface is sprayed by anodic oxidation and outdoor grade

灯具材质: 采用优质航空铝材
Lamp material: Use high quality aviation aluminum to form

应用场景/Application scenario





XTD-GG09

详细参数/SPECIFICATION

光源/Light source:	著名品牌LED光源/famous brand LED light source
常规功率/Conventional power:	10-12W
灯具尺寸/Lamp size:	L1000xW24xH30mm/L1000xW30xH35mm
工作电压/Voltage:	DC24V
灯具寿命/Lamp life:	>30000H
LED光色/LED color:	R/Y/B/G/W/WW/RGB
色彩效果/Colour effect:	全彩、单色/full colour, monochrome
防护等级/Protection grade:	IP65
环境温度/Environment temperature:	-30℃~+50℃
发光角度/Light angle:	60° /120°



线条尺寸图/Line size chart

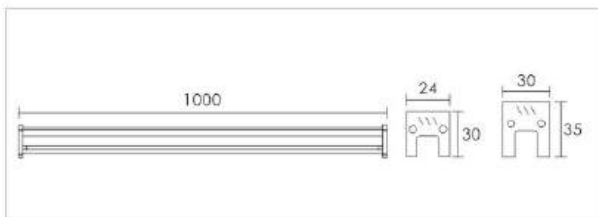

产品细节图/Product detail map



应用场景/Application scenario



中间出线/Intermediate outlet 两头出线/Two outlets

表面处理: 表面经阳极氧化、户外等级喷涂处理
Surface treatment: The surface is sprayed by anodic oxidation and outdoor grade
灯具材质: 采用优质航空铝材、钢化玻璃面盖
Lamp material: Use high quality aviation aluminum to form, Tempered glass cover



XTD-GG10

详细参数/SPECIFICATION

光源/Light source:	著名品牌LED光源/famous brand LED light source
常规功率/Conventional power:	10-12W
灯具尺寸/Lamp size:	L1000xW26xH47mm/L1000xW32xH60mm
工作电压/Voltage:	DC24V
灯具寿命/Lamp life:	>30000H
LED光色/LED color:	R/Y/B/G/W/WW/RGB
色彩效果/Colour effect:	全彩、单色/full colour, monochrome
防护等级/Protection grade:	IP65
环境温度/Environment temperature:	-30℃~+50℃
发光角度/Light angle:	60° /120°



线条尺寸图/Line size chart

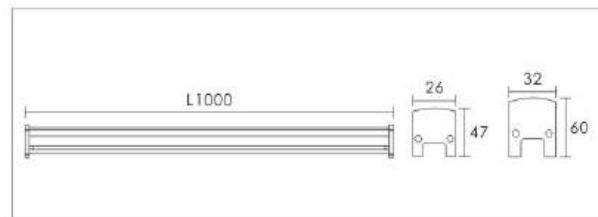

产品细节图/Product detail map



中间出线/Intermediate outlet 两头出线/Two outlets

表面处理: 表面经阳极氧化、户外等级喷涂处理
Surface treatment: The surface is sprayed by anodic oxidation and outdoor grade
灯具材质: 采用优质航空铝材、亚克力面罩
Lamp material: Use high quality aviation aluminum to form, Acrylic mask

应用场景/Application scenario





XTD-LL11

详细参数/SPECIFICATION

光源/Light source:	著名品牌LED光源/famous brand LED light source
常规功率/Conventional power:	10-14W
工作电压/Voltage:	DC24V
灯具寿命/Lamp life:	≥30000H
LED光色/LED color:	R/Y/B/G/W/WW/RGB
色彩效果/Colour effect:	全彩、单色/full colour, monochrome
防护等级/Protection grade:	IP65
环境温度/Environment temperature:	-30℃~+50℃
发光角度/Light angle:	60° /120°



线条尺寸图/Line size chart

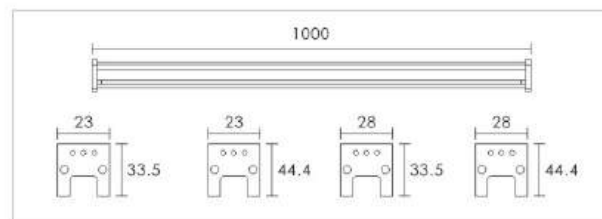

产品细节图/Product detail map



应用场景/Application scenario



应用场所: 建筑群外墙、广告牌、绿化景观、大楼、酒吧、舞厅等外墙照明
Application places: Buildings, billboards, landscaping, buildings, bars, dance halls, etc exterior lighting



XTD-LL12

详细参数/SPECIFICATION

光源/Light source:	著名品牌LED光源/famous brand LED light source
常规功率/Conventional power:	12W/14W
灯具尺寸/Lamp size:	L1000xW45xH40mm
工作电压/Voltage:	DC24V
灯具寿命/Lamp life:	≥30000H
LED光色/LED color:	R/Y/B/G/W/WW/RGB
色彩效果/Colour effect:	全彩、单色/full colour, monochrome
防护等级/Protection grade:	IP65
环境温度/Environment temperature:	-30℃~+50℃
发光角度/Light angle:	60° /120°



线条尺寸图/Line size chart

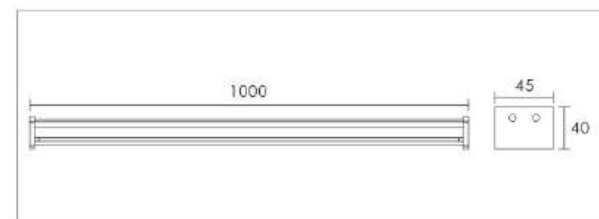

产品细节图/Product detail map

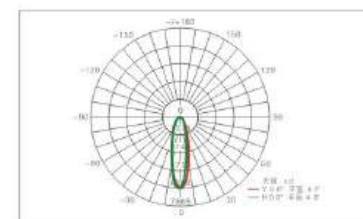

应用场景/Application scenario



表面处理: 表面经阳极氧化、户外等级喷涂处理
Surface treatment: The surface is sprayed by anodic oxidation and outdoor grade

灯具材质: 采用优质航空铝材、钢化玻璃面盖
Lamp material: Use high quality aviation aluminum to form. Tempered glass cover

应用场所: 建筑群外墙、广告牌、绿化景观、大楼、酒吧、舞厅等外墙照明
Application places: Buildings, billboards, landscaping, buildings, bars, dance halls, etc exterior lighting

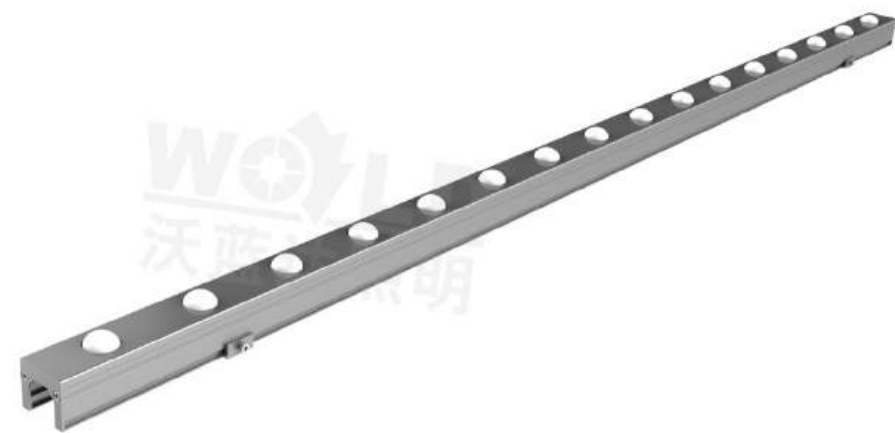

XTD-LL13

详细参数/SPECIFICATION

光源/Light source:	著名品牌LED光源/famous brand LED light source
常规功率/Conventional power:	12W
灯具尺寸/Lamp size:	L1000xW30xH27mm
工作电压/Voltage:	DC24V
灯具寿命/Lamp life:	≥30000H
LED光色/LED color:	R/Y/B/G/W/WW/RGB
色彩效果/Colour effect:	全彩、单色/full colour, monochrome
防护等级/Protection grade:	IP65
环境温度/Environment temperature:	-30℃~+50℃
发光角度/Light angle:	60° /120°

线条尺寸图/Line size chart

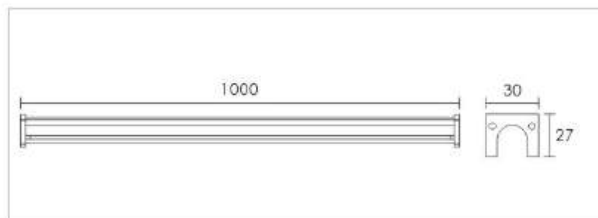

产品细节图/Product detail map

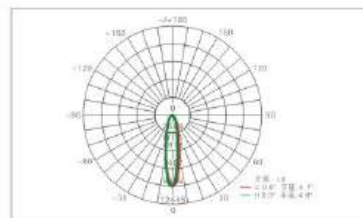

应用场景/Application scenario



表面处理: 表面经阳极氧化、户外等级喷涂处理
Surface treatment: The surface is sprayed by anodic oxidation and outdoor grade

灯具材质: 采用优质航空铝材
Lamp material: Use high quality aviation aluminum to form

应用场所: 建筑群外墙、广告牌、绿化景观、大楼、酒吧、舞厅等外墙照明
Application places: Buildings, billboards, landscaping, buildings, bars, dance halls, etc exterior lighting



XTD-CH14

详细参数/SPECIFICATION

光源/Light source:	著名品牌LED光源/famous brand LED light source
常规功率/Conventional power:	12W
灯具尺寸/Lamp size:	L974xW30xH26mm
工作电压/Voltage:	DC24V
灯具寿命/Lamp life:	≥30000H
LED光色/LED color:	R/Y/B/G/W/WW/RGB
色彩效果/Colour effect:	全彩、单色/full colour, monochrome
防护等级/Protection grade:	IP65
环境温度/Environment temperature:	-30℃~+50℃
发光角度/Light angle:	60° /120°

线条尺寸图/Line size chart



产品细节图/Product detail map



应用场景/Application scenario



表面处理: 表面经阳极氧化、户外等级喷涂处理
Surface treatment: The surface is sprayed by anodic oxidation and outdoor grade

灯具材质: 采用优质航空铝材
Lamp material: Use high quality aviation aluminum to form

应用场所: 建筑群外墙、广告牌、绿化景观、大楼、酒吧、舞厅等外墙照明
Application places: Buildings, billboards, landscaping, buildings, bars, dance halls, etc exterior lighting



XTD-CH15

详细参数/SPECIFICATION

光源/Light source:	著名品牌LED光源/famous brand LED light source
常规功率/Conventional power:	12W
灯具尺寸/Lamp size:	L982xW29xH21mm
工作电压/Voltage:	DC24V
灯具寿命/Lamp life:	>30000H
LED光色/LED color:	R/Y/B/G/W/WW/RGB
色彩效果/Colour effect:	全彩、单色/full colour, monochrome
防护等级/Protection grade:	IP65
环境温度/Environment temperature:	-30℃~+50℃
发光角度/Light angle:	60° /120°



线条尺寸图/Line size chart



产品细节图/Product detail map



应用场景/Application scenario



表面处理: 表面经阳极氧化、户外等级喷涂处理
Surface treatment: The surface is sprayed by anodic oxidation and outdoor grade

灯具材质: 采用优质航空铝材、亚克力面罩
Lamp material: Use high quality aviation aluminum to form, Acrylic mask

应用场所: 建筑群外墙、广告牌、绿化景观、大楼、酒吧、舞厅等外墙照明
Application places: Buildings, billboards, landscaping, buildings, bars, dance halls, etc exterior lighting



XTD-CH16

详细参数/SPECIFICATION

光源/Light source:	著名品牌LED光源/famous brand LED light source
常规功率/Conventional power:	12W
灯具尺寸/Lamp size:	L980xW20xH32.5mm
工作电压/Voltage:	DC24V
灯具寿命/Lamp life:	>30000H
LED光色/LED color:	R/Y/B/G/W/WW/RGB
色彩效果/Colour effect:	全彩、单色/full colour, monochrome
防护等级/Protection grade:	IP65
环境温度/Environment temperature:	-30℃~+50℃
发光角度/Light angle:	120°

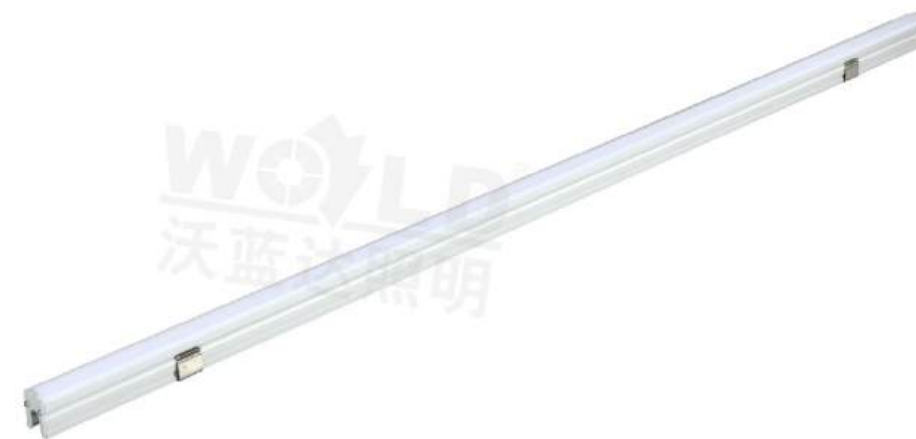

线条尺寸图/Line size chart

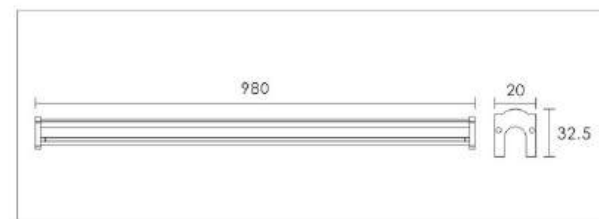

产品细节图/Product detail map



应用场景/Application scenario



表面处理: 表面经阳极氧化、户外等级喷涂处理
Surface treatment: The surface is sprayed by anodic oxidation and outdoor grade

灯具材质: 采用优质航空铝材、亚克力面罩
Lamp material: Use high quality aviation aluminum to form, Acrylic mask

应用场所: 建筑群外墙、广告牌、绿化景观、大楼、酒吧、舞厅等外墙照明
Application places: Buildings, billboards, landscaping, buildings, bars, dance halls, etc exterior lighting

LED LINELLAE LIGHT SERIES
LED线条灯系列



XTD-CH17
详细参数/SPECIFICATION
光源Light source:
著名品牌LED光源
常规功率Conventional power:
12W
灯具尺寸/Lamp size:
L980xW20xH38mm
工作电压/Voltage:
DC24V
灯具寿命/Lamp life:
>30000H
LED光色/LED color:
R/Y/B/G/W/WW/RGB
色彩效果/Colour effect:
全彩、单色/full colour, monochrome
防护等级/Protection grade:
IP65
环境温度/Environment temperature:
-30℃~+50℃
发光角度/Light angle:
60° /120°

线条尺寸图/Line size chart

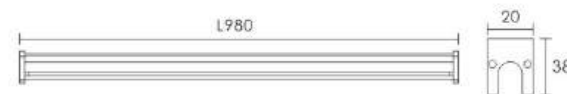

XTD-018
详细参数/SPECIFICATION
光源Light source:
著名品牌LED光源
常规功率Conventional power:
10-12W
灯具尺寸/Lamp size:
L1000xW23xH28mm
工作电压/Voltage:
DC24V
灯具寿命/Lamp life:
>30000H
LED光色/LED color:
R/Y/B/G/W/WW/RGB
色彩效果/Colour effect:
全彩、单色/full colour, monochrome
防护等级/Protection grade:
IP65
环境温度/Environment temperature:
-30℃~+50℃
发光角度/Light angle:
30° /60° /120°

线条尺寸图/Line size chart

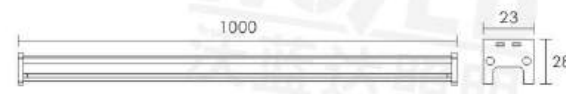

LED LINELLAE LIGHT SERIES
LED线条灯系列



XTD-GG21
详细参数/SPECIFICATION
光源Light source:
著名品牌LED光源
常规功率Conventional power:
10-12W
灯具尺寸/Lamp size:
L1000xW24xH42mm/L1000xW30xH45mm
工作电压/Voltage:
DC24V
灯具寿命/Lamp life:
>30000H
LED光色/LED color:
R/Y/B/G/W/WW/RGB
色彩效果/Colour effect:
全彩、单色/full colour, monochrome
防护等级/Protection grade:
IP65
环境温度/Environment temperature:
-30℃~+50℃
发光角度/Light angle:
60° /120°

线条尺寸图/Line size chart



XTD-CH22
详细参数/SPECIFICATION
光源Light source:
著名品牌LED光源
常规功率Conventional power:
10W
灯具尺寸/Lamp size:
L962xW30xH10mm
工作电压/Voltage:
DC24V
灯具寿命/Lamp life:
>30000H
LED光色/LED color:
R/Y/B/G/W/WW/RGB
色彩效果/Colour effect:
全彩、单色/full colour, monochrome
防护等级/Protection grade:
IP65
环境温度/Environment temperature:
-30℃~+50℃
发光角度/Light angle:
60° /120°

线条尺寸图/Line size chart

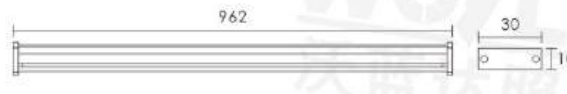

XTD-019
详细参数/SPECIFICATION
光源Light source:
著名品牌LED光源
常规功率Conventional power:
12-18W
灯具尺寸/Lamp size:
L1000xW23xH18mm
工作电压/Voltage:
DC24V
灯具寿命/Lamp life:
>30000H
LED光色/LED color:
R/Y/B/G/W/WW/RGB
色彩效果/Colour effect:
全彩、单色/full colour, monochrome
防护等级/Protection grade:
IP65
环境温度/Environment temperature:
-30℃~+50℃
发光角度/Light angle:
30° /60° /120°

线条尺寸图/Line size chart

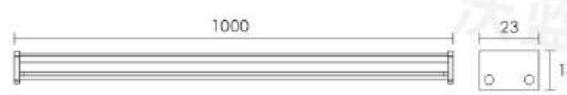

XTD-020
详细参数/SPECIFICATION
光源Light source:
著名品牌LED光源
常规功率Conventional power:
10-15W
灯具尺寸/Lamp size:
L1000xW28xH22mm
工作电压/Voltage:
DC24V
灯具寿命/Lamp life:
>30000H
LED光色/LED color:
R/Y/B/G/W/WW/RGB
色彩效果/Colour effect:
全彩、单色/full colour, monochrome
防护等级/Protection grade:
IP65
环境温度/Environment temperature:
-30℃~+50℃
发光角度/Light angle:
30° /60° /120°

线条尺寸图/Line size chart

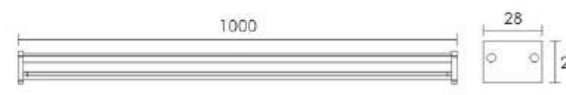

XTD-GG23
详细参数/SPECIFICATION
光源Light source:
著名品牌LED光源
常规功率Conventional power:
10-12W
灯具尺寸/Lamp size:
L1000xW26xH36mm/L1000xW32xH40mm
工作电压/Voltage:
DC24V
灯具寿命/Lamp life:
>30000H
LED光色/LED color:
R/Y/B/G/W/WW/RGB
色彩效果/Colour effect:
全彩、单色/full colour, monochrome
防护等级/Protection grade:
IP65
环境温度/Environment temperature:
-30℃~+50℃
发光角度/Light angle:
60° /120°

线条尺寸图/Line size chart



XTD-024
详细参数/SPECIFICATION
光源Light source:
著名品牌LED光源
常规功率Conventional power:
12-18W
灯具尺寸/Lamp size:
L1000xW30xH50mm
工作电压/Voltage:
DC24V
灯具寿命/Lamp life:
>30000H
LED光色/LED color:
R/Y/B/G/W/WW/RGB
色彩效果/Colour effect:
全彩、单色/full colour, monochrome
防护等级/Protection grade:
IP65
环境温度/Environment temperature:
-30℃~+50℃
发光角度/Light angle:
30° /60° /120°

线条尺寸图/Line size chart

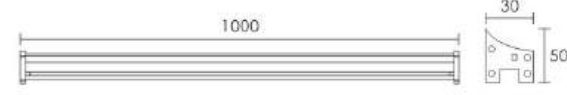



XSD-001

详细参数/SPECIFICATION

光源/Light source:	著名品牌LED光源/famous brand LED light source
单颗LED功率/Single star LED power:	SMD LED
常规功率/Conventional power:	18W
灯具尺寸/Lamp size:	L1000xW40xH25mm
工作电压/Voltage:	DC24V/AC220V
灯具寿命/Lamp life:	>20000H
LED光色/LED color:	R/Y/B/G/W/WW/RGB
防护等级/Protection grade:	IP67
环境温度/Environment temperature:	-35℃~+40℃
发光角度/Light angle:	120°

线条尺寸图/Line size chart

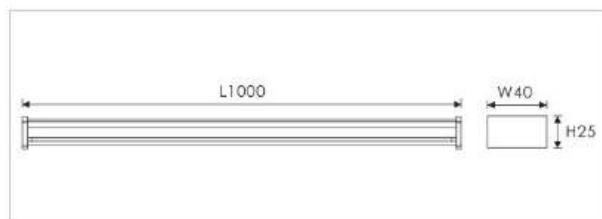

产品细节图/Product detail map



应用场景/Application scenario



表面处理: 抗紫外线聚酯粉, 户外等级喷涂
Surface treatment: anti-ultraviolet polyester powder, spray outdoor level

灯具材质: 防紫外亚克力灯罩, 灯体为拉伸铝
Lamp material: Prevent ultraviolet acrylic lampshade, lamp body for tensile aluminum

应用场所: 高档住宅、娱乐场所、会所、商场、机场、地铁、高架、立交桥、广告、酒店等照明
Application places: High-end residential, entertainment venues, clubs, shopping malls, airports, subways, viaducts, overpasses, advertising, hotels and other lighting.



XSD-002

详细参数/SPECIFICATION

光源/Light source:	著名品牌LED光源/famous brand LED light source
单颗LED功率/Single star LED power:	SMD LED
常规功率/Conventional power:	18W
灯具尺寸/Lamp size:	L1000xW60xH25mm
工作电压/Voltage:	DC24V/AC220V
灯具寿命/Lamp life:	>20000H
LED光色/LED color:	R/Y/B/G/W/WW/RGB
防护等级/Protection grade:	IP67
环境温度/Environment temperature:	-35℃~+40℃
发光角度/Light angle:	120°

线条尺寸图/Line size chart

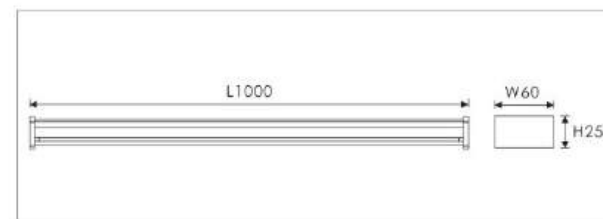

配光曲线图/Light distribution curve

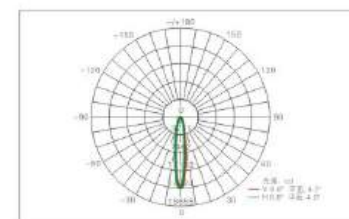

应用场景/Application scenario



表面处理: 抗紫外线聚酯粉, 户外等级喷涂
Surface treatment: anti-ultraviolet polyester powder, spray outdoor level

灯具材质: 防紫外亚克力灯罩, 灯体为拉伸铝
Lamp material: Prevent ultraviolet acrylic lampshade, lamp body for tensile aluminum

应用场所: 高档住宅、娱乐场所、会所、商场、机场、地铁、高架、立交桥、广告、酒店等照明
Application places: High-end residential, entertainment venues, clubs, shopping malls, airports, subways, viaducts, overpasses, advertising, hotels and other lighting.

LED GUARDRAIL TUBE SERIES LED护栏管系列

产品特点

- 光源采用超高亮度LED作为光源,有红、黄、蓝、绿、白、紫、青、七彩等颜色,通过晶片控制。
- 可实现渐变、跳变、色彩闪烁、随机交替、追逐等流动变化,色彩艳丽,光通量高。
- 灯罩采用耐高、低温,抗老化、防紫外线、防潮PC材质,有透明和乳白管两款,具有高透光,高抗击,高强度及抗紫外线特点。
- 铝合金底座结构,高分子数字对装,使用更安全,更防水,更耐用,外观线条流畅,美观亮丽。
- 两端采用ABS材料制作的端头及高温硅胶防水圈,具有很好的防水性能,线材采用四芯六芯防水护套线制作母对插件,安装方便。

适用范围

广泛应用于:立交桥、大厦轮廓、广场、商场、酒店大厦、娱乐场所、展厅、高架桥、广告牌背景、桥梁栏杆、交通道、河道、湖护栏、花园、建筑物轮廓、灯柱、城市夜景亮化工程,可产生彩虹般绚丽的效果,是美化城市的理想光源。

Product features

- Light source adopts high brightness LED as light source, there are red, yellow, blue, green, white, purple, green, colorful, such as color, through the chip control.
- Mixer can achieve gradient, jump, color flashing, random alternate, chasing the flow changes, colour is gorgeous, high luminous flux.
- Lampshade adopts the high and low temperature resistance, anti-aging, uv protection, moistureproof PC material, have transparent and white tube two, high pervious to light, high combat, high strength and resistance to ultraviolet radiation characteristics.
- Pieces of aluminum alloy base structure, polymer digital to install, use more secure, more waterproof, durable, look line is fluent, beautiful and bright.
- Pieces at both ends by the end of the ABS material and high temperature silicone waterproof circle, has a good waterproof performance, waterproof jacket wire with four core six core line production of male female for plug-ins, installation is convenient.

Scope of application

Are widely used in: overpass, building outline, squares, shopping malls, hotels, entertainment venues, exhibition hall, the viaduct, billboard background, bridge railing guardrail, traffic road, river, lake, Garden view, building outline, light, city lighting engineering, can produce the result that rainbow gorgeous, is an ideal light source to beauty the city.



绿色照明 节能环保 超长寿命 高显色性 温度极低

LED GUARDRAIL TUBE SERIES LED护栏管系列

HLG-001

详细参数/SPECIFICATION

光源/Light source:	著名品牌LED光源/famous brand LED light source
常规功率/Conventional power:	10-12W
灯具尺寸/Lamp size:	L1000xW23xH43mm
工作电压/Voltage:	DC24V
LED光色/LED color:	R/Y/B/G/W/WW/RGB
色彩效果/Colour effect:	全彩、单色/full colour, monochrome
控制方式/Control mode:	国际标准DMX512
防护等级/Protection grade:	IP65
环境温度/Environment temperature:	-30°C~+50°C
发光角度/Light angle:	120°



线条尺寸图/Line size chart

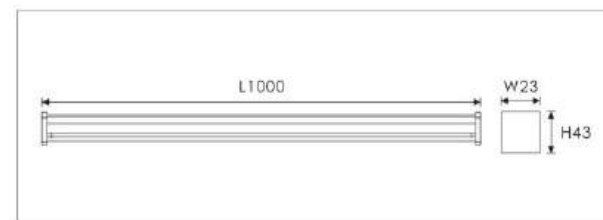

配光曲线图/Light distribution curve

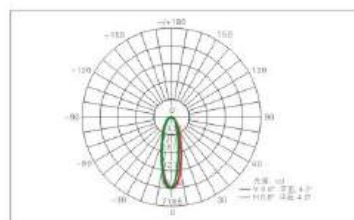

应用场景/Application scenario

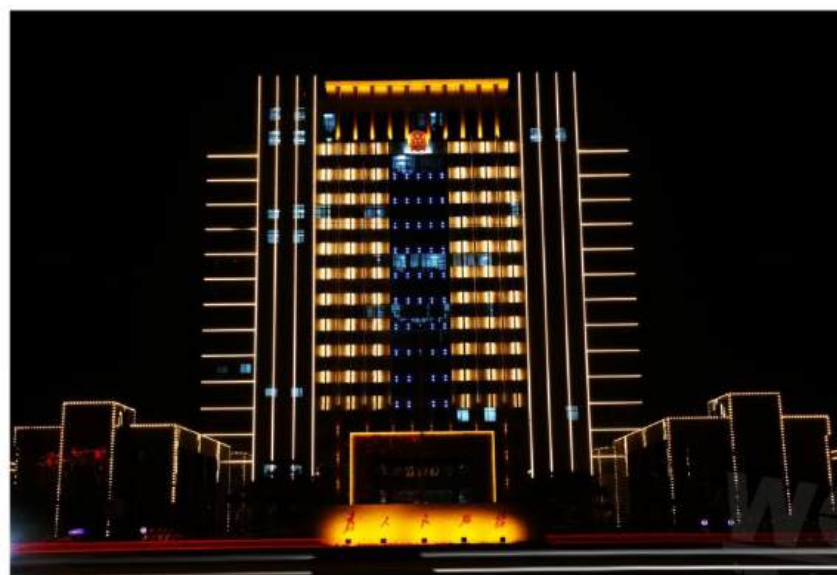

表面处理: 表面户外等级防水处理
Surface treatment: Surface outdoor grade waterproof treatment

灯具材质: 采用耐高、低温, 抗老化、防紫外线、防潮PC材质, 铝合金底座
Lamp material: Adopt PC material of high and low temperature resistance, aging resistance, uv resistance, moisture resistance, aluminum alloy base

应用场所: 立交桥、大厦轮廓、广场、酒店大厦、娱乐场所、展厅、高架桥、广告牌背景等照明
Application places: Overpass, building outline, square, hotel building, entertainment place, exhibition hall, viaduct, billboard background lighting



HLG-002

详细参数/SPECIFICATION

光源/Light source:	著名品牌LED光源/famous brand LED light source
常规功率/Conventional power:	10-15W
灯具尺寸/Lamp size:	L1000xW47xH50mm
工作电压/Voltage:	DC24V
LED光色/LED color:	R/Y/B/G/W/WW/RGB
色彩效果/Colour effect:	全彩、单色/full colour, monochrome
控制方式/Control mode:	国际标准DMX512
防护等级/Protection grade:	IP65
环境温度/Environment temperature:	-30°C~+50°C
发光角度/Light angle:	120°



线条尺寸图/Line size chart

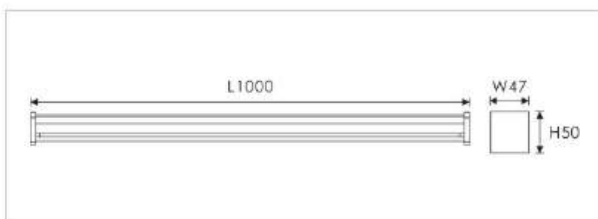

配光曲线图/Light distribution curve

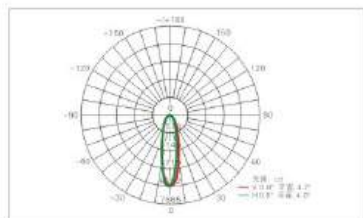

应用场景/Application scenario



表面处理: 表面户外等级防水处理
Surface treatment: Surface outdoor grade waterproof treatment

灯具材质: 采用耐高、低温, 抗老化、防紫外线、防潮PC材质, 铝合金底座
Lamp material: Adopt PC material of high and low temperature resistance, aging resistance, uv resistance, moisture resistance, aluminum alloy base

应用场所: 立交桥、大厦轮廓、广场、酒店大厦、娱乐场所、展厅、高架桥、广告牌背景等照明
Application places: Overpass, building outline, square, hotel building, entertainment place, exhibition hall, viaduct, billboard background lighting



HLG-003

详细参数/SPECIFICATION

光源/Light source:	著名品牌LED光源/famous brand LED light source
常规功率/Conventional power:	10-15W
灯具尺寸/Lamp size:	L1000xW50xH35mm
工作电压/Voltage:	DC24V
LED光色/LED color:	R/Y/B/G/W/WW/RGB
色彩效果/Colour effect:	全彩、单色/full colour, monochrome
控制方式/Control mode:	国际标准DMX512
防护等级/Protection grade:	IP65
环境温度/Environment temperature:	-30°C~+50°C
发光角度/Light angle:	120°



线条尺寸图/Line size chart

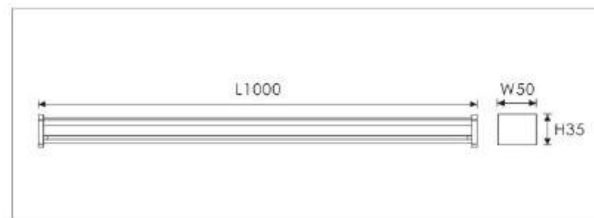

配光曲线图/Light distribution curve

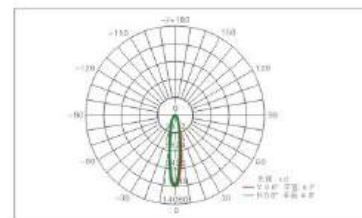

应用场景/Application scenario



表面处理: 表面户外等级防水处理
Surface treatment: Surface outdoor grade waterproof treatment

灯具材质: 采用耐高、低温, 抗老化、防紫外线、防潮PC材质, 铝合金底座
Lamp material: Adopt PC material of high and low temperature resistance, aging resistance, uv resistance, moisture resistance, aluminum alloy base

应用场所: 立交桥、大厦轮廓、广场、酒店大厦、娱乐场所、展厅、高架桥、广告牌背景等照明
Application places: Overpass, building outline, square, hotel building, entertainment place, exhibition hall, viaduct, billboard background lighting



WOYLD
沃蓝达照明



产品特点

- 灯具外壳采用优质铝合金、不锈钢及整体压铸灯体，造型别致，可调节方向及角度；
- 灯具采用钢化玻璃及橡胶、硅胶密封，内部环氧树脂灌封，具有良好的防水性能；
- 低耗高效进口光源，光通量高、显色性强、使用寿命可达5万小时；
- PMMA光学透镜，可选角度15° 30° 45° 60°；
- 内置恒流AC85V-AC265V宽电压驱动，确保灯具在不同国家、区域或电压不稳时可正常工作，另有低压AC24V驱动可供选择；
- 灯具控制方式：单色常亮效果（红、绿、蓝、黄、白、暖白）；内控同步RGB七彩变化；外控同步RGB七彩变化；国际标准DMX512协议控制系统；
- 防水等级：IP65。

适用范围

广泛应用于公园、广场、写字楼、酒吧、酒店及建筑外墙、楼体立柱、广场灯光、园林树木、道路等室外亮化。

Product features

- Lamp body is made of good quality aluminum alloy, stainless steel or die-cast aluminum with exquisite and unique design, it could be adjusted to different direction.
- Lamp is sealed by reinforced glass, rubber ring, silica gel and silicone to make sure water proof..
- Imported low consumption & high efficiency LEDs has high CRI and luminous flux, lifespan could reach fifty thousand hours.
- PMMA lens, 15 degree, 30 degree, 45 degree, 60 degree for your choice.
- Built-in LED driver with IC ensure stability of the light, it could work efficiently under AC100 to AC240V considering different countries, regions and/or in case unstable voltage. AC24V LED driver is also available
- Control: Continuous lighting effect for single color like red, green, blue, yellow, white and warm white, internal controlled synchronous seven changing RGB, external controlled synchronous seven changing RGB with international standard DMX512 control system.
- Protection level: Ip65.

Scope of application

Usage range: this series of products applicable to the park, Plaza, offices, bars, hotels and exterior wall, building body round column square lighting, landscape trees, roads and other outdoor lighting.

WOYLD
沃蓝达照明

使用说明书 Instruction manual

投光灯是一款突显建筑特色和艺术景观的完美实用的照明产品，灯具结构紧凑，造型美观。整灯构件均采用铝合金压铸成型，表面烤户外漆，具有良好的耐候性能。出光玻璃采用结构紧固防水设计，密封性能良好，玻璃和灯具平面平齐设计，不易积水积尘。灯具的结构有两个自由度可以调整，可以达到更为精确的投射角度，配以精确的二次光学设计，确保了建筑和艺术景观对光的最高要求，功能强大的内置DMX512控制系统支持自联机控制，可在脱机模式下通过手动灯具背面的按钮选择所需的场景渲染效果。

The floodlight is a perfect and practical lighting product that highlights the architectural features and artistic landscape. The lamps are compact in structure and beautiful in appearance. The whole lamp components are made of aluminum alloy die-casting and the surface is baked with outdoor paint. Has good weather resistance. The light-emitting glass adopts structural fastening and waterproof design, and has good sealing performance. The glass and the lamp are flush and flat, and it is not easy to accumulate water and dust. The structure of the luminaire has two freedoms the degree can be adjusted to achieve a more precise projection angle, with precise secondary optical design, ensuring the highest requirements for light in buildings and art landscapes. The powerful built-in DMX512 control system supports self-online control and can be offline. In the mode, select the desired scene rendering effect by the button on the back of the manual light fixture.

安装示意图 The installation drawing

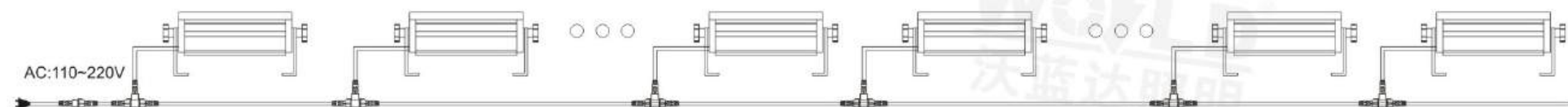

说明：每个回路上220V导线上可并接20台，确保金属外壳连接地线。
Note: 220V wire for each loop 20 can be, and then make sure the metal casing connects to the earth.

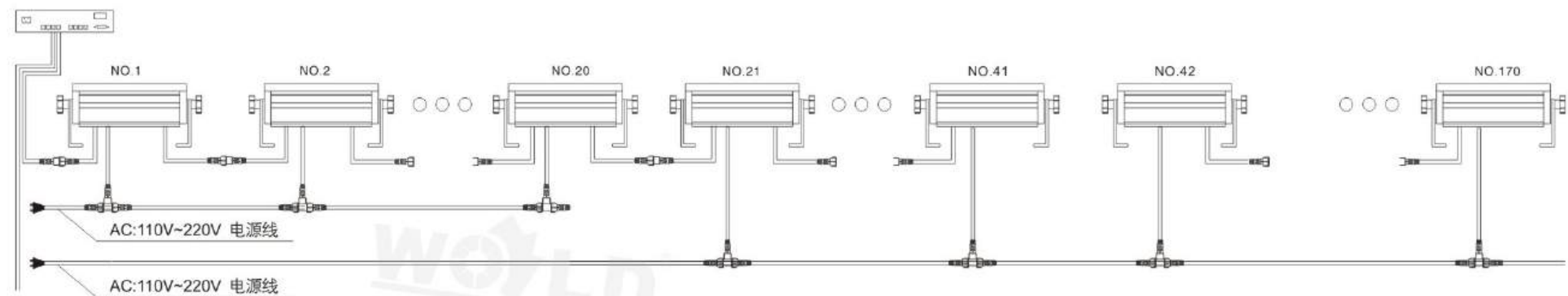

说明：DMX512-1600第一个输出端口可接170台大功率投光灯，每个回路上220V导线上可并接20台，确保金属外壳连接地线。
Note: DMX512-1600 can connect each output port 170 sets of high power lamps for light, 220V wire for each loop 20 can be, and then make sure the metal casing connects to the earth.

产品解析说明 Product analysis instructions

选材·解析



高品质铝材灯体

采用精工铝材，不生锈，不褪色，具有良好的抗腐蚀和抗裂能力。



高亮LED芯片

采用高亮芯片，发光面积大，显色好无光斑、无红外线紫外线，无辐射无频闪，更稳定，寿命更长。



光学透镜

采用亚克力光学透镜，光效强，射强远，光线柔和，有引光光效功能。



可调固定支架

采用不锈钢材质，高强度不易滑，安全稳定不易腐蚀生锈，防损坏，坚固经久耐用。



不锈钢螺丝

整灯采用不锈钢材质，硬度极强，不易滑丝，不腐蚀不生锈，防水性强，牢固稳定。



空气对流散热器

采用一体化加厚铝，工业级散热，空气强对流原理，多片式散热，导热性更佳，完美解决散热问题，保护光源使用寿命。



防水出线口

金属防水出线口设计，双重防水，不惧风雨。



国标全铜线

国标三芯全铜线材，导电强，功率高，线材柔软，不易折断，专业稳流，耐候性强，防雷击。



LED FLOOD LIGHT SERIES
LED投光灯系列



TGD-YY01

详细参数/SPECIFICATION

光源/Light source:	著名品牌LED光源/famous brand LED light source
常规功率/Conventional power:	9*2W/12*2W/18*2W/24*2W/36*2W/64*2W
工作电压/Voltage:	AC85-265V
灯具寿命/Lamp life:	>30000H
LED光色/LED color:	R/Y/B/G/W/WW/RGB
色彩效果/Colour effect:	全彩、单色/full colour, monochrome
控制方式/Control mode:	国际标准DMX512/International standard DMX512
防护等级/Protection grade:	IP65
环境温度/Environment temperature:	-30℃~+50℃
发光角度/Light angle:	15° /30° /45° /60° /90°

线条尺寸图/Line size chart | 产品细节图/Product detail map | 配光曲线图/Light distribution curve | 应用场景/Application scenario

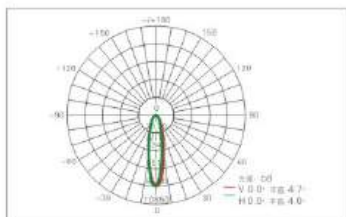

工作电压、LED光色、安装方式等可非标定制
Working voltage, LED light color, installation mode, etc, as non-standard custom

LED FLOOD LIGHT SERIES
LED投光灯系列



TGD-YY02

详细参数/SPECIFICATION

光源/Light source:	著名品牌LED光源/famous brand LED light source
常规功率/Conventional power:	18*2W/24*2W/36*2W/48*2W/72*2W/128*2W/27*2W/36*2W
工作电压/Voltage:	AC85-265V
灯具寿命/Lamp life:	>30000H
LED光色/LED color:	R/Y/B/G/W/WW/RGB
色彩效果/Colour effect:	全彩、单色/full colour, monochrome
控制方式/Control mode:	国际标准DMX512/International standard DMX512
防护等级/Protection grade:	IP65
环境温度/Environment temperature:	-30℃~+50℃
发光角度/Light angle:	15° /30° /45° /60° /90°

线条尺寸图/Line size chart | 产品细节图/Product detail map | 配光曲线图/Light distribution curve | 应用场景/Application scenario

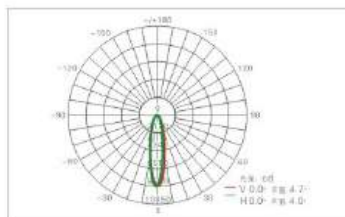
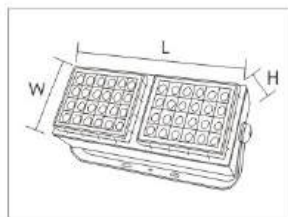



TGD-YY03

详细参数/SPECIFICATION

光源/Light source:	著名品牌LED光源/famous brand LED light source
常规功率/Conventional power:	54*2W/72*2W/108*2W/192*2W/108*2W/144*2W 216*2W/384*2W/162*2W/216*2W/324*2W/576*2W
工作电压/Voltage:	AC85-265V
灯具寿命/Lamp life:	>30000H
LED光色/LED color:	R/Y/B/G/W/WW/RGB
色彩效果/Colour effect:	全彩、单色/full colour, monochrome
控制方式/Control mode:	国际标准DMX512/International standard DMX512
防护等级/Protection grade:	IP65
环境温度/Environment temperature:	-30℃~+50℃
发光角度/Light angle:	15° /30° /45° /60° /90°



线条尺寸图/Line size chart

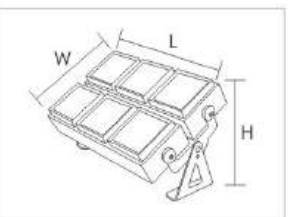

产品细节图/Product detail map

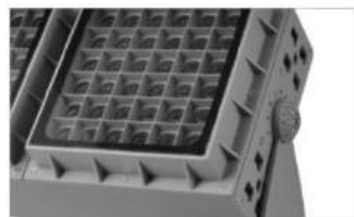

配光曲线图/Light distribution curve

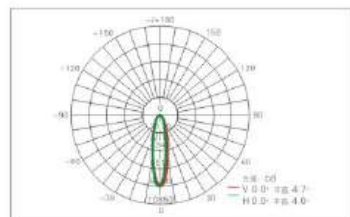

应用场景/Application scenario



TGD-YY04

详细参数/SPECIFICATION

光源/Light source:	著名品牌LED光源/famous brand LED light source
常规功率/Conventional power:	70W/16*4W/36*2W
工作电压/Voltage:	AC85-265V
灯具寿命/Lamp life:	>30000H
LED光色/LED color:	R/Y/B/G/W/WW/RGB
色彩效果/Colour effect:	全彩、单色/full colour, monochrome
控制方式/Control mode:	国际标准DMX512/International standard DMX512
防护等级/Protection grade:	IP65
环境温度/Environment temperature:	-30℃~+50℃
发光角度/Light angle:	3° /8° /12° /24° /36° /60° /120°



线条尺寸图/Line size chart

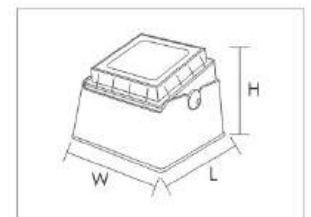

产品细节图/Product detail map



配光曲线图/Light distribution curve

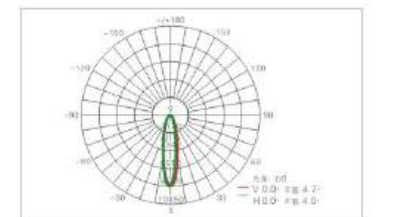

应用场景/Application scenario



工作电压、LED光色、安装方式等可非标定制
Working voltage, LED light color, installation mode, etc, as non-standard custom

LED FLOOD LIGHT SERIES
LED投光灯系列



TGD-YY05

详细参数/SPECIFICATION

光源/Light source:	著名品牌LED光源/famous brand LED light source
常规功率/Conventional power:	18*2W/24*2W/36*1.5W/72*1.5W
工作电压/Voltage:	AC85-265V
灯具寿命/Lamp life:	>30000H
LED光色/LED color:	R/Y/B/G/W/WW/RGB
色彩效果/Colour effect:	全彩、单色/full colour, monochrome
控制方式/Control mode:	国际标准DMX512/International standard DMX512
防护等级/Protection grade:	IP65
环境温度/Environment temperature:	-30℃~+50℃
发光角度/Light angle:	15° /30° /45° /60° /90°

线条尺寸图/Line size chart | 产品细节图/Product detail map | 配光曲线图/Light distribution curve | 应用场景/Application scenario



工作电压、LED光色、安装方式等可非标定制
Working voltage, LED light color, installation mode, etc, as non-standard custom

LED FLOOD LIGHT SERIES
LED投光灯系列



TGD-YY06

详细参数/SPECIFICATION

光源/Light source:	著名品牌LED光源/famous brand LED light source
常规功率/Conventional power:	9*2W/18*4W/24*2W/36*1.5W/72*1.5W
工作电压/Voltage:	AC85-265V
灯具寿命/Lamp life:	>30000H
LED光色/LED color:	R/Y/B/G/W/WW/RGB
色彩效果/Colour effect:	全彩、单色/full colour, monochrome
控制方式/Control mode:	国际标准DMX512/International standard DMX512
防护等级/Protection grade:	IP65
环境温度/Environment temperature:	-30℃~+50℃
发光角度/Light angle:	15° /30° /45° /60° /90°

线条尺寸图/Line size chart | 产品细节图/Product detail map | 配光曲线图/Light distribution curve | 应用场景/Application scenario



工作电压、LED光色、安装方式等可非标定制
Working voltage, LED light color, installation mode, etc, as non-standard custom



TGD-BT07

详细参数/SPECIFICATION

光源/Light source:	著名品牌LED光源/famous brand LED light source
常规功率/Conventional power:	12-24W/24-36W/36-54W
工作电压/Voltage:	AC85-265V
灯具寿命/Lamp life:	>30000H
LED光色/LED color:	R/Y/B/G/W/WW/RGB
色彩效果/Colour effect:	全彩、单色/full colour, monochrome
控制方式/Control mode:	国际标准DMX512/International standard DMX512
防护等级/Protection grade:	IP65
环境温度/Environment temperature:	-30℃~+50℃
发光角度/Light angle:	15° /30° /45° /60° /90°

线条尺寸图/Line size chart

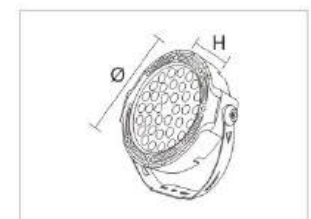

产品细节图/Product detail map



配光曲线图/Light distribution curve

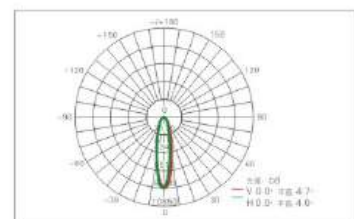

应用场景/Application scenario



12-24W
Ø240xH189.5mm
24-36W
Ø236xH230.5mm
36-54W
Ø296xH282mm

工作电压、LED光色、安装方式等可非标定制
Working voltage, LED light color, installation mode, etc, as non-standard custom



TGD-BT08

详细参数/SPECIFICATION

光源/Light source:	著名品牌LED光源/famous brand LED light source
常规功率/Conventional power:	6-12W/24-36W/36-54W
工作电压/Voltage:	AC85-265V
灯具寿命/Lamp life:	>30000H
LED光色/LED color:	R/Y/B/G/W/WW/RGB
色彩效果/Colour effect:	全彩、单色/full colour, monochrome
控制方式/Control mode:	国际标准DMX512/International standard DMX512
防护等级/Protection grade:	IP65
环境温度/Environment temperature:	-30℃~+50℃
发光角度/Light angle:	15° /30° /45° /60° /90°

线条尺寸图/Line size chart

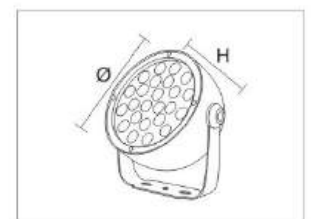

产品细节图/Product detail map



配光曲线图/Light distribution curve

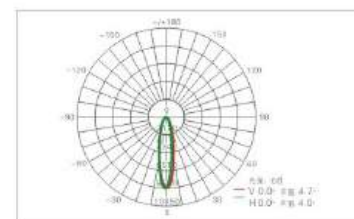

应用场景/Application scenario



6-12W
Ø115mm
24-36W
Ø200mm
36-54W
Ø230mm

工作电压、LED光色、安装方式等可非标定制
Working voltage, LED light color, installation mode, etc, as non-standard custom



TGD-BT09

详细参数/SPECIFICATION

光源/Light source:	著名品牌LED光源/famous brand LED light source
常规功率/Conventional power:	16x1.5W/24x1.5W/36x1.5W
工作电压/Voltage:	AC85-265V
灯具寿命/Lamp life:	>30000H
LED光色/LED color:	R/Y/B/G/W/WW/RGB
色彩效果/Colour effect:	全彩、单色/full colour, monochrome
控制方式/Control mode:	国际标准DMX512/International standard DMX512
防护等级/Protection grade:	IP65
环境温度/Environment temperature:	-30℃~+50℃
发光角度/Light angle:	15° /30° /45° /60° /90°

线条尺寸图/Line size chart

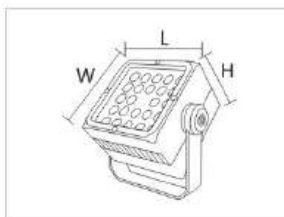

产品细节图/Product detail map



配光曲线图/Light distribution curve

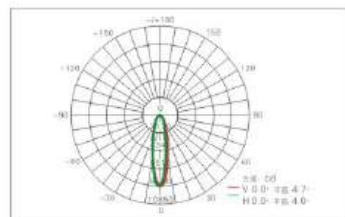

应用场景/Application scenario



16x1.5W L130xW130xH195mm	24-36W L150xW150xH213mm	36-54W L180xW180xH247.5mm

工作电压、LED光色、安装方式等可非标定制
Working voltage, LED light color, installation mode, etc, as non-standard custom



TGD-BT10

详细参数/SPECIFICATION

光源/Light source:	著名品牌LED光源/famous brand LED light source
常规功率/Conventional power:	24-36W/36-48W
工作电压/Voltage:	AC85-265V
灯具寿命/Lamp life:	>30000H
LED光色/LED color:	R/Y/B/G/W/WW/RGB
色彩效果/Colour effect:	全彩、单色/full colour, monochrome
控制方式/Control mode:	国际标准DMX512/International standard DMX512
防护等级/Protection grade:	IP65
环境温度/Environment temperature:	-30℃~+50℃
发光角度/Light angle:	15° /30° /45° /60° /90°

线条尺寸图/Line size chart

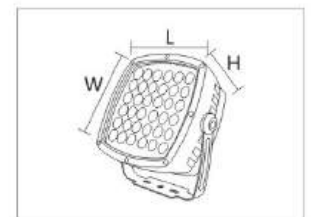

产品细节图/Product detail map



配光曲线图/Light distribution curve

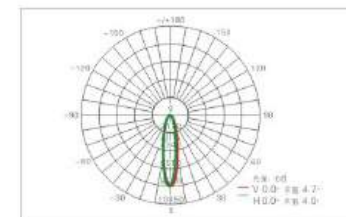

应用场景/Application scenario



24-36W L236xW257.5xH106.8mm	36-48W L262xW302.5xH98mm

工作电压、LED光色、安装方式等可非标定制
Working voltage, LED light color, installation mode, etc, as non-standard custom



TGD-BT11

详细参数/SPECIFICATION

光源/Light source:	著名品牌LED光源/famous brand LED light source
常规功率/Conventional power:	9-18W/16-32W/24-48W
工作电压/Voltage:	AC85-265V
灯具寿命/Lamp life:	>30000H
LED光色/LED color:	R/Y/B/G/W/WW/RGB
色彩效果/Colour effect:	全彩、单色/full colour, monochrome
控制方式/Control mode:	国际标准DMX512/International standard DMX512
防护等级/Protection grade:	IP65
环境温度/Environment temperature:	-30℃~+50℃
发光角度/Light angle:	15° /30° /45° /60° /90°

线条尺寸图/Line size chart



产品细节图/Product detail map



配光曲线图/Light distribution curve

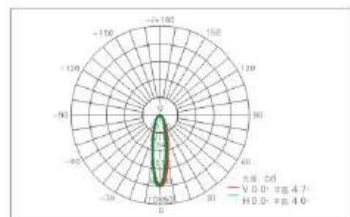

应用场景/Application scenario

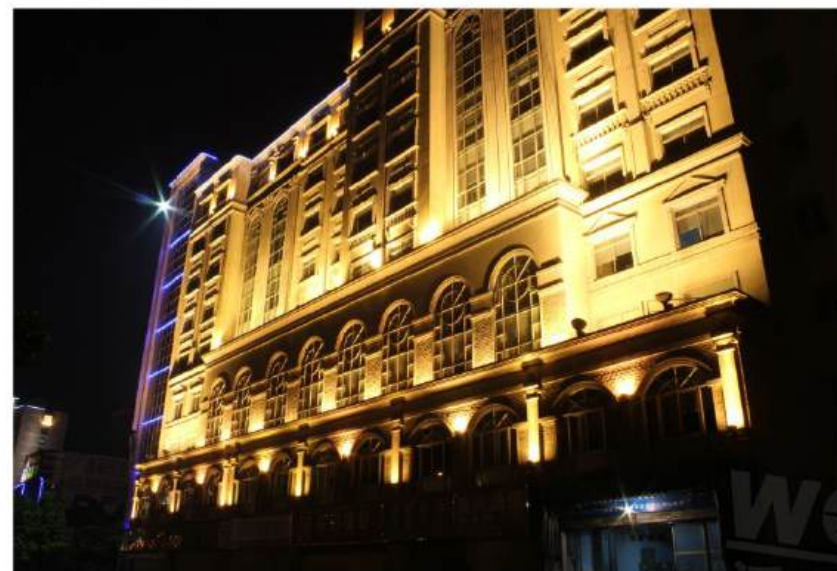

9-18W
L125xW140xH75mm



16-32W
L170xW180xH80mm



24-48W
L198xW225xH85mm

工作电压、LED光色、安装方式等可非标定制
Working voltage, LED light color, installation mode, etc, as non-standard custom



TGD-HL12

详细参数/SPECIFICATION

光源/Light source:	著名品牌LED光源/famous brand LED light source
常规功率/Conventional power:	18/24/36/54*1-3W 6/12/18/36*1-5W
工作电压/Voltage:	AC85-265V
灯具寿命/Lamp life:	>30000H
LED光色/LED color:	R/Y/B/G/W/WW/RGB
色彩效果/Colour effect:	全彩、单色/full colour, monochrome
控制方式/Control mode:	国际标准DMX512/International standard DMX512
防护等级/Protection grade:	IP65
环境温度/Environment temperature:	-30℃~+50℃
发光角度/Light angle:	5° /15° /30° /60°

线条尺寸图/Line size chart

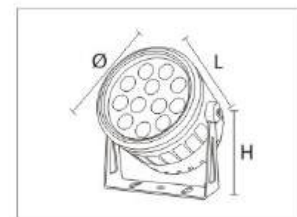

产品细节图/Product detail map



配光曲线图/Light distribution curve

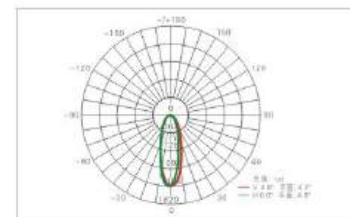

应用场景/Application scenario



18*1-3W 6*1-5W
Ø183xL155xH175mm



24*1-3W 12*1-5W
Ø219xL190xH209mm



36*1-3W 18*1-5W
Ø247xL220xH235mm



54*1-3W 36*1-5W
Ø280xL250xH263mm

工作电压、LED光色、安装方式等可非标定制
Working voltage, LED light color, installation mode, etc, as non-standard custom



TGD-HL13

详细参数/SPECIFICATION

光源/Light source:	著名品牌LED光源/famous brand LED light source
常规功率/Conventional power:	18*1-2W/9*1-3W/36*1-2W/16*1-3W/ 18*1-2W*2头/9*1-3W*3头
工作电压/Voltage:	AC85-265V
灯具寿命/Lamp life:	>30000H
LED光色/LED color:	R/Y/B/G/W/WW/RGB
色彩效果/Colour effect:	全彩、单色/full colour, monochrome
控制方式/Control mode:	国际标准DMX512/International standard DMX512
防护等级/Protection grade:	IP65
环境温度/Environment temperature:	-30℃~+50℃
发光角度/Light angle:	5° /15° /30° /60°

线条尺寸图/Line size chart

产品细节图/Product detail map

配光曲线图/Light distribution curve

应用场景/Application scenario

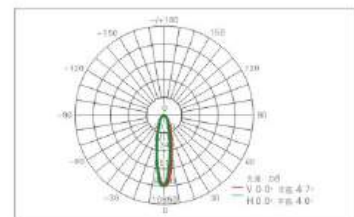

工作电压、LED光色、安装方式等可非标定制
Working voltage, LED light color, installation mode, etc, as non-standard custom



TGD-HL14

详细参数/SPECIFICATION

光源/Light source:	著名品牌LED光源/famous brand LED light source
常规功率/Conventional power:	16*1-3W/24*1-3W/36*1-3W/72*1-3W
工作电压/Voltage:	AC85-265V
灯具寿命/Lamp life:	>30000H
LED光色/LED color:	R/Y/B/G/W/WW/RGB
色彩效果/Colour effect:	全彩、单色/full colour, monochrome
控制方式/Control mode:	国际标准DMX512/International standard DMX512
防护等级/Protection grade:	IP65
环境温度/Environment temperature:	-30℃~+50℃
发光角度/Light angle:	5° /15° /30° /60°

线条尺寸图/Line size chart

产品细节图/Product detail map

配光曲线图/Light distribution curve

应用场景/Application scenario

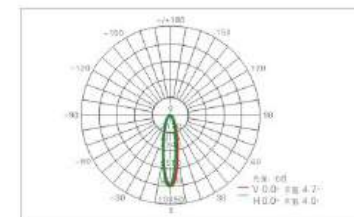
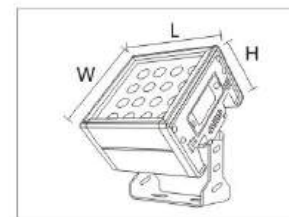

工作电压、LED光色、安装方式等可非标定制
Working voltage, LED light color, installation mode, etc, as non-standard custom

LED FLOOD LIGHT SERIES
LED投光灯系列



TGD-AD15

详细参数/SPECIFICATION

光源/Light source:	著名品牌LED光源/famous brand LED light source
常规功率/Conventional power:	12W/24W/36W
工作电压/Voltage:	AC85-265V
灯具寿命/Lamp life:	>30000H
LED光色/LED color:	R/Y/B/G/W/WW/RGB
色彩效果/Colour effect:	全彩、单色/full colour, monochrome
控制方式/Control mode:	国际标准DMX512/International standard DMX512
防护等级/Protection grade:	IP65
环境温度/Environment temperature:	-30℃~+50℃
发光角度/Light angle:	5° /15° /30° /45°

线条尺寸图/Line size chart



产品细节图/Product detail map



配光曲线图/Light distribution curve

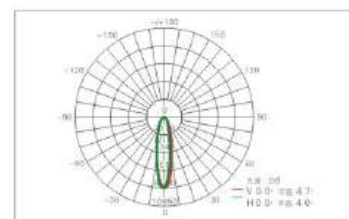

应用场景/Application scenario



工作电压、LED光色、安装方式等可非标定制
Working voltage, LED light color, installation mode, etc, as non-standard custom

LED FLOOD LIGHT SERIES
LED投光灯系列



TGD-LL16

详细参数/SPECIFICATION

光源/Light source:	著名品牌LED光源/famous brand LED light source
常规功率/Conventional power:	3x3W/9x2W/12x2W/24x2W/36x2W/10W/20W/30W
工作电压/Voltage:	AC85-265V
灯具寿命/Lamp life:	>30000H
LED光色/LED color:	R/Y/B/G/W/WW/RGB
色彩效果/Colour effect:	全彩、单色/full colour, monochrome
控制方式/Control mode:	国际标准DMX512/International standard DMX512
防护等级/Protection grade:	IP65
环境温度/Environment temperature:	-30℃~+50℃
发光角度/Light angle:	5° /15° /30° /45°

线条尺寸图/Line size chart



产品细节图/Product detail map



配光曲线图/Light distribution curve

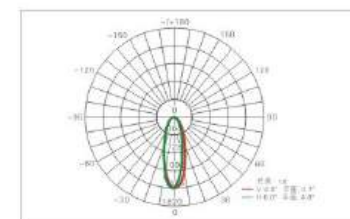

应用场景/Application scenario



工作电压、LED光色、安装方式等可非标定制
Working voltage, LED light color, installation mode, etc, as non-standard custom



TGD-AD17

详细参数/SPECIFICATION

光源/Light source:	著名品牌LED光源/famous brand LED light source
常规功率/Conventional power:	12W/12*2W / 24W/24*2W / 36W/36*2W
工作电压/Voltage:	AC85-265V
灯具寿命/Lamp life:	≥30000H
LED光色/LED color:	R/Y/B/G/W/WW/RGB
色彩效果/Colour effect:	全彩、单色/full colour, monochrome
控制方式/Control mode:	国际标准DMX512/International standard DMX512
防护等级/Protection grade:	IP65
环境温度/Environment temperature:	-30℃~+50℃
发光角度/Light angle:	5° /15° /30° /45° /60° /90°

线条尺寸图/Line size chart 产品细节图/Product detail map 配光曲线图/Light distribution curve 应用场景/Application scenario

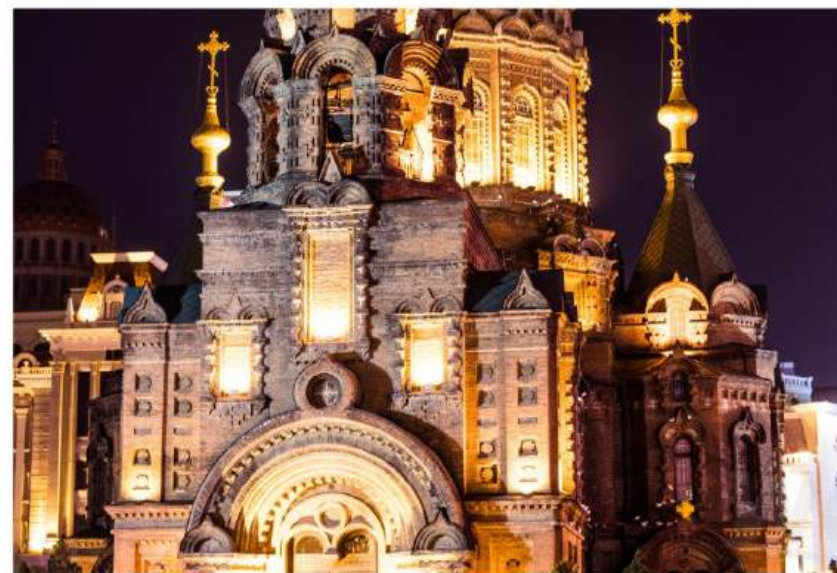
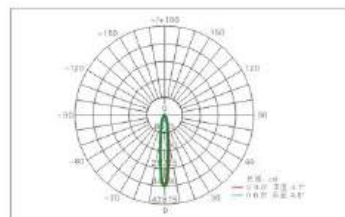

12W/12*2W
Ø140mm

24W/24*2W
Ø185mm

36W/36*2W
Ø215mm

工作电压、LED光色、安装方式等可非标定制
Working voltage, LED light color, installation mode, etc, as non-standard custom



TGD-AD18

详细参数/SPECIFICATION

光源/Light source:	著名品牌LED光源/famous brand LED light source
常规功率/Conventional power:	16W/16*2W / 24W/24*2W / 36W/36*2W
工作电压/Voltage:	AC85-265V
灯具寿命/Lamp life:	≥30000H
LED光色/LED color:	R/Y/B/G/W/WW/RGB
色彩效果/Colour effect:	全彩、单色/full colour, monochrome
控制方式/Control mode:	国际标准DMX512/International standard DMX512
防护等级/Protection grade:	IP65
环境温度/Environment temperature:	-30℃~+50℃
发光角度/Light angle:	5° /15° /30° /45° /60° /90°

线条尺寸图/Line size chart 产品细节图/Product detail map 配光曲线图/Light distribution curve 应用场景/Application scenario

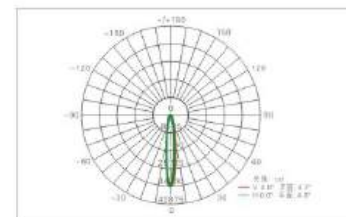
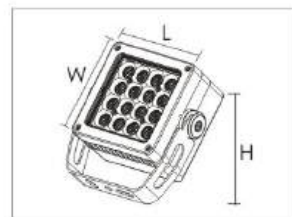

16W/16*2W
L150*W150*H205mm

24W/24*2W
L175*W175*H230mm

36W/36*2W
L200*W200*H250mm

工作电压、LED光色、安装方式等可非标定制
Working voltage, LED light color, installation mode, etc, as non-standard custom



TGD-LL19

详细参数/SPECIFICATION

光源/Light source:	著名品牌LED光源/famous brand LED light source
常规功率/Conventional power:	5x3W/15x1-1.5W/12x3W/24x1W/24x1-1.5W
工作电压/Voltage:	AC85-265V
灯具寿命/Lamp life:	≥30000H
LED光色/LED color:	R/Y/B/G/W/WW/RGB
色彩效果/Colour effect:	全彩、单色/full colour, monochrome
控制方式/Control mode:	国际标准DMX512/International standard DMX512
防护等级/Protection grade:	IP65
环境温度/Environment temperature:	-30℃~+50℃
发光角度/Light angle:	5° /15° /30° /45°

线条尺寸图/Line size chart

产品细节图/Product detail map

配光曲线图/Light distribution curve

应用场景/Application scenario

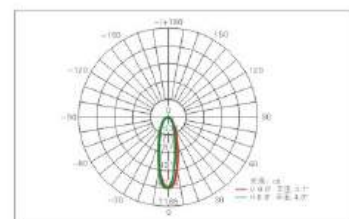

5X3W
Ø135xH119mm

15x1W/15x1.5W
Ø135xH119mm

12x3W
Ø190xH130mm

24x1W/24x1.5W
Ø190xH130mm

工作电压、LED光色、安装方式等可非标定制
Working voltage, LED light color, installation mode, etc, as non-standard custom



TGD-LL20

详细参数/SPECIFICATION

光源/Light source:	著名品牌LED光源/famous brand LED light source
常规功率/Conventional power:	16x3W/36x1-1.5W/28x3W/48x1-1.5W
工作电压/Voltage:	AC85-265V
灯具寿命/Lamp life:	≥30000H
LED光色/LED color:	R/Y/B/G/W/WW/RGB
色彩效果/Colour effect:	全彩、单色/full colour, monochrome
控制方式/Control mode:	国际标准DMX512/International standard DMX512
防护等级/Protection grade:	IP65
环境温度/Environment temperature:	-30℃~+50℃
发光角度/Light angle:	5° /15° /30° /45°

线条尺寸图/Line size chart

产品细节图/Product detail map

配光曲线图/Light distribution curve

应用场景/Application scenario

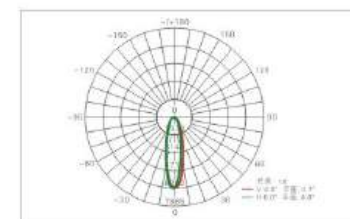
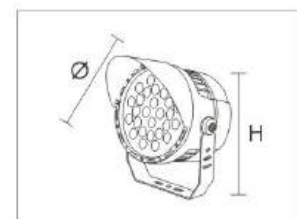

16x3W
Ø230xL157mm

36x1W/36x1.5W
Ø230xL157mm

28x3W
Ø290xH185mm

48x1W/48x1.5W
Ø290xH185mm

工作电压、LED光色、安装方式等可非标定制
Working voltage, LED light color, installation mode, etc, as non-standard custom



TGD-SH21



详细参数/SPECIFICATION

光源/Light source:	著名品牌LED光源/famous brand LED light source
常规功率/Conventional power:	36x2W/60x2W/120x2W
工作电压/Voltage:	AC85-265V
灯具寿命/Lamp life:	≥30000H
LED光色/LED color:	R/Y/B/G/W/WW/RGB
色彩效果/Colour effect:	全彩、单色/full colour, monochrome
控制方式/Control mode:	国际标准DMX512/International standard DMX512
防护等级/Protection grade:	IP65
环境温度/Environment temperature:	-30℃~+50℃
发光角度/Light angle:	8° /15° /30° /45°

线条尺寸图/Line size chart

产品细节图/Product detail map

配光曲线图/Light distribution curve

应用场景/Application scenario



工作电压、LED光色、安装方式等可非标定制
Working voltage, LED light color, installation mode, etc, as non-standard custom



TGD-XY22



详细参数/SPECIFICATION

光源/Light source:	著名品牌LED光源/famous brand LED light source
常规功率/Conventional power:	4x5W/5x5W/9x5W/16x5W/16x8W
工作电压/Voltage:	AC85-265V
灯具寿命/Lamp life:	≥30000H
LED光色/LED color:	R/Y/B/G/W/WW/RGB
色彩效果/Colour effect:	全彩、单色/full colour, monochrome
控制方式/Control mode:	国际标准DMX512/International standard DMX512
防护等级/Protection grade:	IP65
环境温度/Environment temperature:	-30℃~+50℃
发光角度/Light angle:	8° /15° /30° /45°

线条尺寸图/Line size chart

产品细节图/Product detail map

配光曲线图/Light distribution curve

应用场景/Application scenario



工作电压、LED光色、安装方式等可非标定制
Working voltage, LED light color, installation mode, etc, as non-standard custom





TGD-LL23

详细参数/SPECIFICATION

光源/Light source:	著名品牌LED光源/famous brand LED light source
常规功率/Conventional power:	2x24W/2x27W/3x24W/3x27W/4x24W/4x27W
工作电压/Voltage:	AC85-265V
灯具寿命/Lamp life:	≥30000H
LED光色/LED color:	R/Y/B/G/W/WW/RGB
色彩效果/Colour effect:	全彩、单色/full colour, monochrome
控制方式/Control mode:	国际标准DMX512/International standard DMX512
防护等级/Protection grade:	IP65
环境温度/Environment temperature:	-30℃~+50℃
发光角度/Light angle:	5° /15° /30° /45°

线条尺寸图/Line size chart



产品细节图/Product detail map



配光曲线图/Light distribution curve

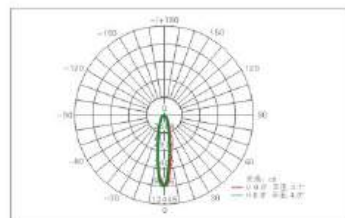

应用场景/Application scenario



TGD-LL24

详细参数/SPECIFICATION

光源/Light source:	著名品牌LED光源/famous brand LED light source
常规功率/Conventional power:	48W/100W(RGB), 60W/130W(RGB), 84W/150W(RGB), 108W/200W(RGB), 108Wx2/200Wx2(RGB)
工作电压/Voltage:	AC85-265V
灯具寿命/Lamp life:	≥30000H
LED光色/LED color:	R/Y/B/G/W/WW/RGB
色彩效果/Colour effect:	全彩、单色/full colour, monochrome
控制方式/Control mode:	国际标准DMX512/International standard DMX512
防护等级/Protection grade:	IP65
环境温度/Environment temperature:	-30℃~+50℃
发光角度/Light angle:	5° /15° /30° /45°

线条尺寸图/Line size chart

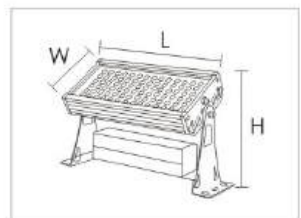

产品细节图/Product detail map



配光曲线图/Light distribution curve

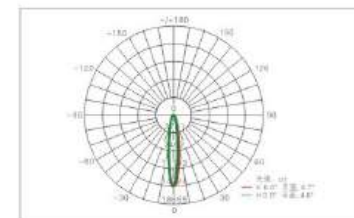

应用场景/Application scenario

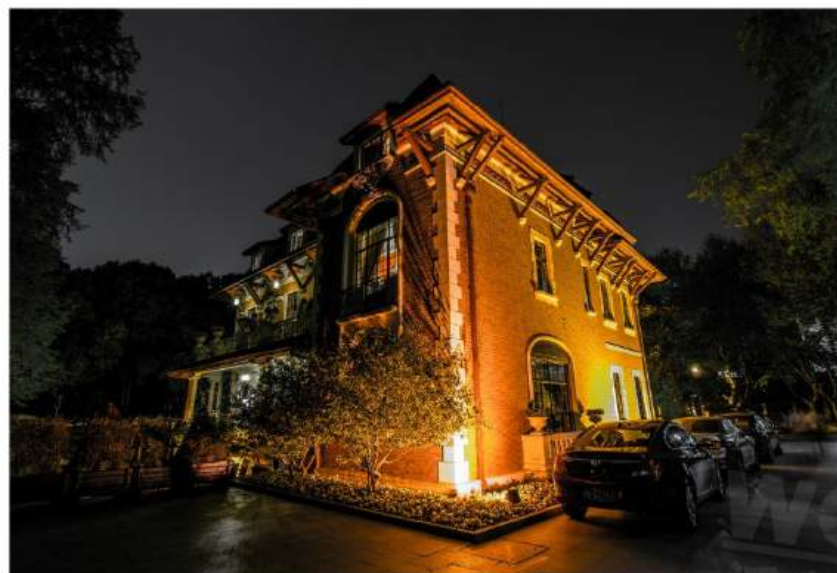



TGD-BT25



详细参数/SPECIFICATION

光源/Light source:	著名品牌LED光源/famous brand LED light source
常规功率/Conventional power:	12x1W/12x2W/24x1W/24x2W
工作电压/Voltage:	AC85-265V
灯具寿命/Lamp life:	≥30000H
LED光色/LED color:	R/Y/B/G/W/WW/RGB
色彩效果/Colour effect:	全彩、单色/full colour, monochrome
控制方式/Control mode:	国际标准DMX512/International standard DMX512
防护等级/Protection grade:	IP65
环境温度/Environment temperature:	-30℃~+50℃
发光角度/Light angle:	5° /15° /30° /45°

线条尺寸图/Line size chart

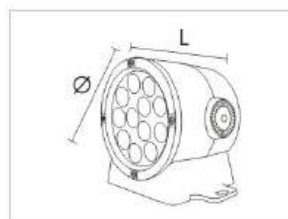

产品细节图/Product detail map



配光曲线图/Light distribution curve

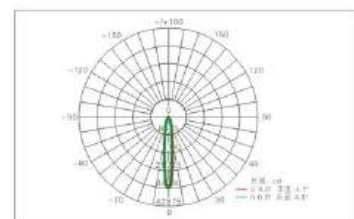

应用场景/Application scenario



工作电压、LED光色、安装方式等可非标定制
Working voltage, LED light color, installation mode, etc, as non-standard custom



TGD-YK26



详细参数/SPECIFICATION

光源/Light source:	著名品牌LED光源/famous brand LED light source
常规功率/Conventional power:	3W/6W/18W
工作电压/Voltage:	AC85-265V
灯具寿命/Lamp life:	≥30000H
LED光色/LED color:	R/Y/B/G/W/WW/RGB
色彩效果/Colour effect:	全彩、单色/full colour, monochrome
控制方式/Control mode:	国际标准DMX512/International standard DMX512
防护等级/Protection grade:	IP65
环境温度/Environment temperature:	-30℃~+50℃
发光角度/Light angle:	30° /60° /90° /120°

线条尺寸图/Line size chart

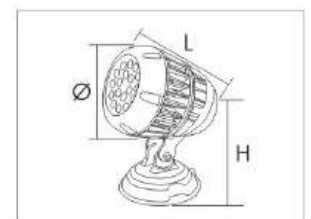

产品细节图/Product detail map



配光曲线图/Light distribution curve

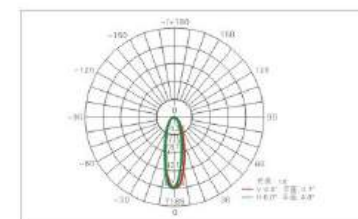

应用场景/Application scenario

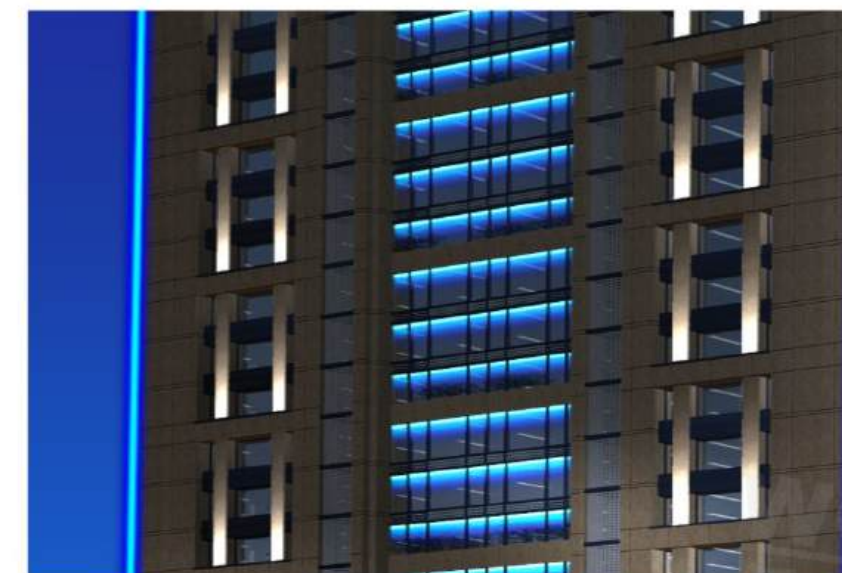

工作电压、LED光色、安装方式等可非标定制
Working voltage, LED light color, installation mode, etc, as non-standard custom



TGD-027

详细参数/SPECIFICATION

光源/Light source:	著名品牌LED光源/famous brand LED light source
常规功率/Conventional power:	12W/18W/24W/36W/72W
工作电压/Voltage:	AC85-265V
灯具寿命/Lamp life:	≥30000H
LED光色/LED color:	R/Y/B/G/W/WW/RGB
色彩效果/Colour effect:	全彩、单色/full colour, monochrome
控制方式/Control mode:	国际标准DMX512/International standard DMX512
防护等级/Protection grade:	IP65
环境温度/Environment temperature:	-30℃~+50℃
发光角度/Light angle:	30° /60° /90° /120°



线条尺寸图/Line size chart

产品细节图/Product detail map

配光曲线图/Light distribution curve

应用场景/Application scenario

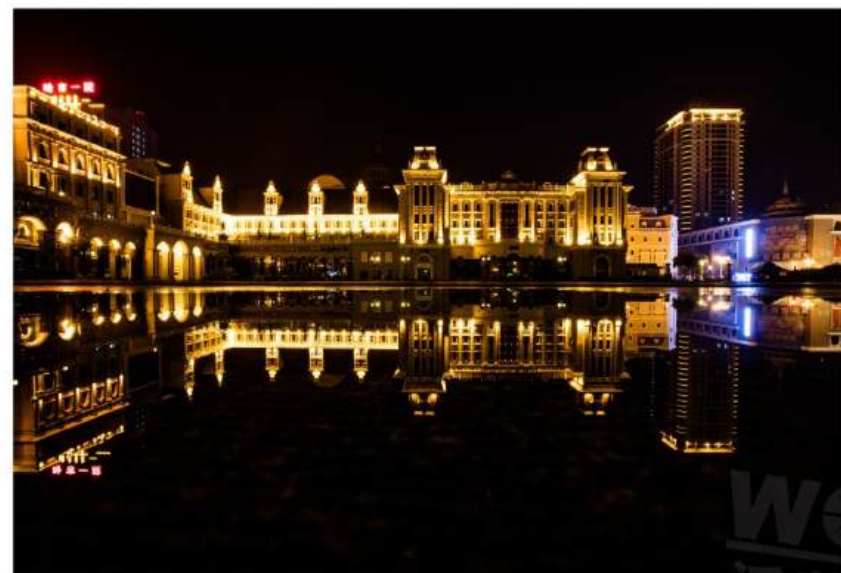
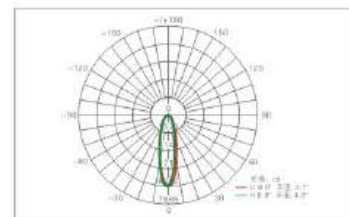
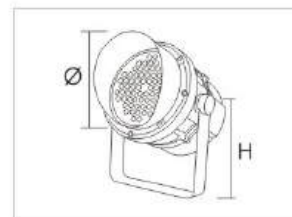

工作电压、LED光色、安装方式等可非标定制
Working voltage, LED light color, installation mode, etc., as non-standard custom



TGD-LL28

详细参数/SPECIFICATION

光源/Light source:	著名品牌LED光源/famous brand LED light source
常规功率/Conventional power:	3W/4W/9W/9x1.5/9x2W/9x3W//24x1W
工作电压/Voltage:	AC85-265V
灯具寿命/Lamp life:	≥30000H
LED光色/LED color:	R/Y/B/G/W/WW/RGB
色彩效果/Colour effect:	全彩、单色/full colour, monochrome
控制方式/Control mode:	国际标准DMX512/International standard DMX512
防护等级/Protection grade:	IP65
环境温度/Environment temperature:	-30℃~+50℃
发光角度/Light angle:	5° /15° /30° /45°



线条尺寸图/Line size chart

产品细节图/Product detail map

配光曲线图/Light distribution curve

应用场景/Application scenario

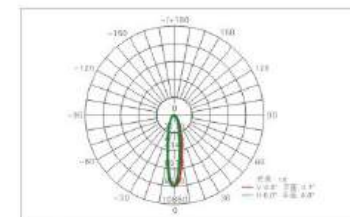

LED FLOOD LIGHT SERIES
LED投光灯系列



TGD-SH29



24W L168xW170xH190mm
36W L245xW170xH190mm
48W L325xW170xH190mm

详细参数/SPECIFICATION

光源Light source:	著名品牌LED光源/famous brand LED light source
常规功率Conventional power:	24W/36W/48W
工作电压/Voltage:	AC85-265V
灯具寿命/Lamp life:	≥30000H
LED光色/LED color:	R/Y/B/G/W/WW/RGB
色彩效果/Colour effect:	全彩、单色/full colour, monochrome
防护等级/Protection grade:	IP65
环境温度/Environment temperature:	-30℃~+50℃
发光角度/Light angle:	15° /30° /45° /60° /90° /120°

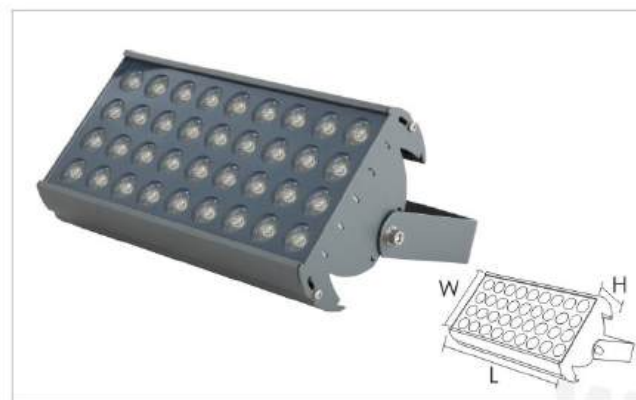

TGD-SH30



24W L165xW130xH60mm
36W L250xW130xH60mm
48W L320xW130xH60mm

详细参数/SPECIFICATION

光源Light source:	著名品牌LED光源/famous brand LED light source
常规功率Conventional power:	24W/36W/48W
工作电压/Voltage:	AC85-265V
灯具寿命/Lamp life:	≥30000H
LED光色/LED color:	R/Y/B/G/W/WW/RGB
色彩效果/Colour effect:	全彩、单色/full colour, monochrome
防护等级/Protection grade:	IP65
环境温度/Environment temperature:	-30℃~+50℃
发光角度/Light angle:	15° /30° /45° /60° /90° /120°



TGD-HL31



72°1-3W L300xW279mm
144°1-3W L563xW279mm

详细参数/SPECIFICATION

光源Light source:	著名品牌LED光源/famous brand LED light source
常规功率Conventional power:	72°1-3W/144°1-3W
工作电压/Voltage:	AC85-265V
灯具寿命/Lamp life:	≥30000H
LED光色/LED color:	R/Y/B/G/W/WW/RGB
色彩效果/Colour effect:	全彩、单色/full colour, monochrome
防护等级/Protection grade:	IP65
环境温度/Environment temperature:	-30℃~+50℃
发光角度/Light angle:	5° /15° /30° /45° /60° /90°

LED FLOOD LIGHT SERIES
LED投光灯系列



TGD-WC32



16W / 24W L130xW75xH180mm
36W L160xW82xH218mm
48W L185xW90xH247mm
96W L220xW95xH291mm

详细参数/SPECIFICATION

光源Light source:	著名品牌LED光源/famous brand LED light source
常规功率Conventional power:	16W/24W/36W/48W/96W
工作电压/Voltage:	AC85-265V
灯具寿命/Lamp life:	≥30000H
LED光色/LED color:	R/Y/B/G/W/WW/RGB
色彩效果/Colour effect:	全彩、单色/full colour, monochrome
防护等级/Protection grade:	IP65
环境温度/Environment temperature:	-30℃~+50℃
发光角度/Light angle:	15° /30° /45° /60° /90° /120°



TGD-WC33



80W/120W/150W RGBW L405xW124xH280mm
240W/300W RGBW L647xW140xH360mm
144W*2/160W RGBW*2 L554xW130xH500mm
240W*2/300W RGBW*2 L703xW140xH536mm

详细参数/SPECIFICATION

光源Light source:	著名品牌LED光源/famous brand LED light source
常规功率Conventional power:	80W/120W/150W(RGB)/240W/300W(RGB) 144W*2/160W(RGB)*2/240W*2/300W(RGB)*2
工作电压/Voltage:	AC85-265V
灯具寿命/Lamp life:	≥30000H
LED光色/LED color:	R/Y/B/G/W/WW/RGB
色彩效果/Colour effect:	全彩、单色/full colour, monochrome
防护等级/Protection grade:	IP65
环境温度/Environment temperature:	-30℃~+50℃
发光角度/Light angle:	15° /30° /45° /60° /90° /120°



TGD-WC34



3°1瓦 /3°3瓦 /3°4瓦 Ø85*W96*H115MM
15瓦 /24瓦 Ø130*W136*H169MM
54瓦 /72瓦 Ø210*W216*H268MM
72瓦 /96瓦 Ø230*W230*H281mm

详细参数/SPECIFICATION

光源Light source:	著名品牌LED光源/famous brand LED light source
常规功率Conventional power:	3W/3°1W/3°3W/15W/24W/54W/72W/96W
工作电压/Voltage:	AC85-265V
灯具寿命/Lamp life:	≥30000H
LED光色/LED color:	R/Y/B/G/W/WW/RGB
色彩效果/Colour effect:	全彩、单色/full colour, monochrome
防护等级/Protection grade:	IP65
环境温度/Environment temperature:	-30℃~+50℃
发光角度/Light angle:	15° /30° /45° /60° /90° /120°

LED FLOOD LIGHT SERIES LED投光灯系列



TGD-035



TGD-YY36



TGD-037



20x1W L135xW175xH110mm
24x1W L130xW165xH135mm
40x1W L160xW210xH140mm

详细参数/SPECIFICATION

光源Light source:	著名品牌LED光源/famous brand LED light source
常规功率Conventional power:	20W/24W/40W
工作电压/Voltage:	AC85-265V
灯具寿命/Lamp life:	≥30000H
LED光色/LED color:	R/Y/B/G/W/WW/RGB
色彩效果/Colour effect:	全彩、单色/full colour, monochrome
防护等级/Protection grade:	IP65
环境温度/Environment temperature:	-30℃~+50℃
发光角度/Light angle:	30° /60° /90° /120°



35W L145xW145xH205mm
16*2W L125xW125xH185mm
25*1.5W L145xW145xH205mm
36*1.5W L185xW185xH245mm

详细参数/SPECIFICATION

光源Light source:	著名品牌LED光源/famous brand LED light source
常规功率Conventional power:	35W/16*2W/25*1.5W/36*1.5W
工作电压/Voltage:	AC85-265V
灯具寿命/Lamp life:	≥30000H
LED光色/LED color:	R/Y/B/G/W/WW/RGB
色彩效果/Colour effect:	全彩、单色/full colour, monochrome
防护等级/Protection grade:	IP65
环境温度/Environment temperature:	-30℃~+50℃
发光角度/Light angle:	12° /24° /36°



10W L100xW100xH90mm
20W L130xW130xH105mm
30W L170xW170xH130mm
50W L210xW210xH130mm

详细参数/SPECIFICATION

光源Light source:	著名品牌LED光源/famous brand LED light source
常规功率Conventional power:	10W/20W/30W/50W
工作电压/Voltage:	AC85-265V
灯具寿命/Lamp life:	≥30000H
LED光色/LED color:	R/Y/B/G/W/WW/RGB
色彩效果/Colour effect:	全彩、单色/full colour, monochrome
防护等级/Protection grade:	IP65
环境温度/Environment temperature:	-30℃~+50℃
发光角度/Light angle:	15° /30° /45° /60° /90° /120°



LED FLOOD LIGHT SERIES LED投光灯系列



TGD-LL38



TGD-CH39



TGD-040



36W/60W(RGB) L200xW150xH168mm
48W/90W(RGB) L284xW150xH168mm
72W/120W(RGB) L368xW150xH168mm

详细参数/SPECIFICATION

光源Light source:	著名品牌LED光源/famous brand LED light source
常规功率Conventional power:	36W/60W(RGB), 48W/90W(RGB), 72W/120W(RGB)
工作电压/Voltage:	AC85-265V
灯具寿命/Lamp life:	≥30000H
LED光色/LED color:	R/Y/B/G/W/WW/RGB
色彩效果/Colour effect:	全彩、单色/full colour, monochrome
防护等级/Protection grade:	IP65
环境温度/Environment temperature:	-30℃~+50℃
发光角度/Light angle:	15° /30° /45° /60° /90° /120°



9-12W L110xW110xH42mm
{9-12W}x2 L110xW220xH42mm
{9-12W}x4 L220xW220xH42mm

详细参数/SPECIFICATION

光源Light source:	著名品牌LED光源/famous brand LED light source
常规功率Conventional power:	9-12W/{9-12W}x2/{9-12W}x4
工作电压/Voltage:	AC85-265V
灯具寿命/Lamp life:	≥30000H
LED光色/LED color:	R/Y/B/G/W/WW/RGB
色彩效果/Colour effect:	全彩、单色/full colour, monochrome
防护等级/Protection grade:	IP65
环境温度/Environment temperature:	-30℃~+50℃
发光角度/Light angle:	15° /30° /45° /60° /90° /120°



36W*2 L280xW148xH80mm*2
48W*2 L360xW148xH80mm*2

详细参数/SPECIFICATION

光源Light source:	著名品牌LED光源/famous brand LED light source
常规功率Conventional power:	36x2W/48x2W
工作电压/Voltage:	AC85-265V
灯具寿命/Lamp life:	≥30000H
LED光色/LED color:	R/Y/B/G/W/WW/RGB
色彩效果/Colour effect:	全彩、单色/full colour, monochrome
防护等级/Protection grade:	IP65
环境温度/Environment temperature:	-30℃~+50℃
发光角度/Light angle:	15° /30° /45° /60° /90° /120°

LED FLOOD LIGHT SERIES
LED投光灯系列



TGD-YY41



25W L125xW125xH185mm
35W L145xW145xH205mm
50W L185xW185xH245mm

详细参数/SPECIFICATION

光源Light source:	著名品牌LED光源/famous brand LED light source
常规功率Conventional power:	25W/35W/50W
工作电压/Voltage:	AC85-265V
灯具寿命/Lamp life:	≥30000H
LED光色/LED color:	R/Y/B/G/W/WW/RGB
色彩效果/Colour effect:	全彩、单色/full colour, monochrome
防护等级/Protection grade:	IP65
环境温度/Environment temperature:	-30℃~+50℃
发光角度/Light angle:	15° /23° /36° /45°



TGD-042



9x1W/9x2W Ø130xH180mm
18x1W Ø160xH200mm
36x1W Ø190xH230mm
54x1W Ø230xH260mm

详细参数/SPECIFICATION

光源Light source:	著名品牌LED光源/famous brand LED light source
常规功率Conventional power:	9W/18W/36W/54W
工作电压/Voltage:	AC85-265V
灯具寿命/Lamp life:	≥30000H
LED光色/LED color:	R/Y/B/G/W/WW/RGB
色彩效果/Colour effect:	全彩、单色/full colour, monochrome
防护等级/Protection grade:	IP65
环境温度/Environment temperature:	-30℃~+50℃
发光角度/Light angle:	15° /30° /45° /60° /90° /120°



TGD-BT43



16x1W/16x2W L125xW125mm
24x1W/24x2W L190xW190mm
16x1W/16x2W L125xW125mm
24x1W/24x2W L190xW190mm

详细参数/SPECIFICATION

光源Light source:	著名品牌LED光源/famous brand LED light source
常规功率Conventional power:	16x1W/16x2W/24x1W/24x2W
工作电压/Voltage:	AC85-265V
灯具寿命/Lamp life:	≥30000H
LED光色/LED color:	R/Y/B/G/W/WW/RGB
色彩效果/Colour effect:	全彩、单色/full colour, monochrome
防护等级/Protection grade:	IP65
环境温度/Environment temperature:	-30℃~+50℃
发光角度/Light angle:	5° /15° /30° /45°



LED FLOOD LIGHT SERIES
LED投光灯系列



TGD-044



5W Ø65xL103xH110mm
10W Ø85xL145xH145mm

详细参数/SPECIFICATION

光源Light source:	著名品牌LED光源/famous brand LED light source
常规功率Conventional power:	5W/10W
工作电压/Voltage:	AC85-265V
灯具寿命/Lamp life:	≥30000H
LED光色/LED color:	R/Y/B/G/W/WW/RGB
色彩效果/Colour effect:	全彩、单色/full colour, monochrome
防护等级/Protection grade:	IP65
环境温度/Environment temperature:	-30℃~+50℃
发光角度/Light angle:	3°



TGD-045



详细参数/SPECIFICATION

光源Light source:	著名品牌LED光源/famous brand LED light source
常规功率Conventional power:	10W/18W/24W
工作电压/Voltage:	AC85-265V
灯具寿命/Lamp life:	≥30000H
LED光色/LED color:	R/Y/B/G/W/WW/RGB
色彩效果/Colour effect:	全彩、单色/full colour, monochrome
防护等级/Protection grade:	IP65
环境温度/Environment temperature:	-30℃~+50℃
发光角度/Light angle:	5° /10°



TGD-046



5W Ø140xL85xH225mm
10W Ø180xL90xH260mm

详细参数/SPECIFICATION

光源Light source:	著名品牌LED光源/famous brand LED light source
常规功率Conventional power:	5W/10W
工作电压/Voltage:	AC85-265V
灯具寿命/Lamp life:	≥30000H
LED光色/LED color:	R/Y/B/G/W/WW/RGB
色彩效果/Colour effect:	全彩、单色/full colour, monochrome
防护等级/Protection grade:	IP65
环境温度/Environment temperature:	-30℃~+50℃
发光角度/Light angle:	5° /10°

LED FLOOD LIGHT SERIES
LED投光灯系列



TGD-XH47



详细参数/SPECIFICATION

光源Light source:	著名品牌LED光源/famous brand LED light source
常规功率Conventional power:	30W/50W/120W/200W
工作电压/Voltage:	AC85-265V
灯具寿命/Lamp life:	>30000H
LED光色/LED color:	R/Y/B/G/W/WW/RGB
色彩效果/Colour effect:	全彩、单色/full colour, monochrome
防护等级/Protection grade:	IP65
环境温度/Environment temperature:	-30°C~+50°C
发光角度/Light angle:	120°



TGD-048



详细参数/SPECIFICATION

光源Light source:	著名品牌LED光源/famous brand LED light source
常规功率Conventional power:	24W/36W/54W
工作电压/Voltage:	AC85-265V
灯具寿命/Lamp life:	>30000H
LED光色/LED color:	R/Y/B/G/W/WW/RGB
色彩效果/Colour effect:	全彩、单色/full colour, monochrome
防护等级/Protection grade:	IP65
环境温度/Environment temperature:	-30°C~+50°C
发光角度/Light angle:	30° /60° /90° /120°



TGD-QB49



详细参数/SPECIFICATION

光源Light source:	著名品牌LED光源/famous brand LED light source
常规功率Conventional power:	9W/12W/18W/36W
工作电压/Voltage:	AC85-265V
灯具寿命/Lamp life:	>30000H
LED光色/LED color:	R/Y/B/G/W/WW/RGB
色彩效果/Colour effect:	全彩、单色/full colour, monochrome
防护等级/Protection grade:	IP65
环境温度/Environment temperature:	-30°C~+50°C
发光角度/Light angle:	30° /60° /90° /120°



LED FLOOD LIGHT SERIES
LED投光灯系列



TGD-XY50



详细参数/SPECIFICATION

光源Light source:	著名品牌LED光源/famous brand LED light source
常规功率Conventional power:	12W/18W/36W/60W/72W
工作电压/Voltage:	AC85-265V
灯具寿命/Lamp life:	>30000H
LED光色/LED color:	R/Y/B/G/W/WW/RGB
色彩效果/Colour effect:	全彩、单色/full colour, monochrome
防护等级/Protection grade:	IP65
环境温度/Environment temperature:	-30°C~+50°C
发光角度/Light angle:	8° /15° /30° /45°



TGD-051



详细参数/SPECIFICATION

光源Light source:	著名品牌LED光源/famous brand LED light source
常规功率Conventional power:	3W/5W/6W/9W/12W/18W
工作电压/Voltage:	AC85-265V
灯具寿命/Lamp life:	>30000H
LED光色/LED color:	R/Y/B/G/W/WW/RGB
色彩效果/Colour effect:	全彩、单色/full colour, monochrome
防护等级/Protection grade:	IP65
环境温度/Environment temperature:	-30°C~+50°C
发光角度/Light angle:	30° /60° /90° /120°



TGD-052



详细参数/SPECIFICATION

光源Light source:	著名品牌LED光源/famous brand LED light source
常规功率Conventional power:	5W/9W/24W/36W
工作电压/Voltage:	AC85-265V
灯具寿命/Lamp life:	>30000H
LED光色/LED color:	R/Y/B/G/W/WW/RGB
色彩效果/Colour effect:	全彩、单色/full colour, monochrome
防护等级/Protection grade:	IP65
环境温度/Environment temperature:	-30°C~+50°C
发光角度/Light angle:	30° /60° /90° /120°

LED FLOOD LIGHT SERIES
LED投光灯系列



TGD-053

详细参数/SPECIFICATION

光源Light source:
著名品牌LED光源
常规功率Conventional power:
6x2W

工作电压/Voltage:
AC85-265V

灯具寿命/Lamp life:
>30000H

LED光色/LED color:
R/Y/B/G/W/WW/RGB

色彩效果/Colour effect:
全彩、单色/full colour, monochrome

防护等级/Protection grade:
IP65

环境温度/Environment temperature:
-30°C~+50°C

灯具材质/Lamp material:
铝材+钢化玻璃/AL+TG

线条尺寸图/Line size chart

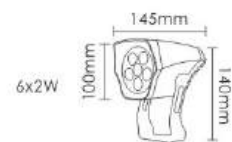

TGD-054

详细参数/SPECIFICATION

光源Light source:
著名品牌LED光源
常规功率Conventional power:
8x2W

工作电压/Voltage:
AC85-265V

灯具寿命/Lamp life:
>30000H

LED光色/LED color:
R/Y/B/G/W/WW/RGB

色彩效果/Colour effect:
全彩、单色/full colour, monochrome

防护等级/Protection grade:
IP65

环境温度/Environment temperature:
-30°C~+50°C

灯具材质/Lamp material:
铝材+钢化玻璃/AL+TG

线条尺寸图/Line size chart

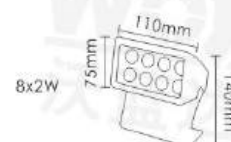

LED FLOOD LIGHT SERIES
LED投光灯系列



TGD-057

详细参数/SPECIFICATION

光源Light source:
著名品牌LED光源
常规功率Conventional power:
1-9W

工作电压/Voltage:
AC85-265V

灯具寿命/Lamp life:
>30000H

LED光色/LED color:
R/Y/B/G/W/WW/RGB

色彩效果/Colour effect:
全彩、单色/full colour, monochrome

防护等级/Protection grade:
IP65

环境温度/Environment temperature:
-30°C~+50°C

灯具材质/Lamp material:
铝材+钢化玻璃/AL+TG

线条尺寸图/Line size chart

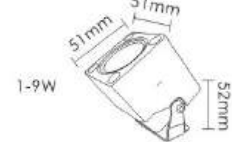

TGD-058

详细参数/SPECIFICATION

光源Light source:
著名品牌LED光源
常规功率Conventional power:
9W/18W

工作电压/Voltage:
AC85-265V

灯具寿命/Lamp life:
>30000H

LED光色/LED color:
R/Y/B/G/W/WW/RGB

色彩效果/Colour effect:
全彩、单色/full colour, monochrome

防护等级/Protection grade:
IP65

环境温度/Environment temperature:
-30°C~+50°C

灯具材质/Lamp material:
铝材+钢化玻璃/AL+TG

线条尺寸图/Line size chart



TGD-055

详细参数/SPECIFICATION

光源Light source:
著名品牌LED光源
常规功率Conventional power:
16W/24W/36W

工作电压/Voltage:
AC85-265V

灯具寿命/Lamp life:
>30000H

LED光色/LED color:
R/Y/B/G/W/WW/RGB

色彩效果/Colour effect:
全彩、单色/full colour, monochrome

防护等级/Protection grade:
IP65

环境温度/Environment temperature:
-30°C~+50°C

灯具材质/Lamp material:
铝材+钢化玻璃/AL+TG

线条尺寸图/Line size chart



TGD-056

详细参数/SPECIFICATION

光源Light source:
著名品牌LED光源
常规功率Conventional power:
6x3W/9x2W/18x2W

工作电压/Voltage:
AC85-265V

灯具寿命/Lamp life:
>30000H

LED光色/LED color:
R/Y/B/G/W/WW/RGB

色彩效果/Colour effect:
全彩、单色/full colour, monochrome

防护等级/Protection grade:
IP65

环境温度/Environment temperature:
-30°C~+50°C

灯具材质/Lamp material:
铝材+钢化玻璃/AL+TG

线条尺寸图/Line size chart



TGD-059

详细参数/SPECIFICATION

光源Light source:
著名品牌LED光源
常规功率Conventional power:
6*1-5W

工作电压/Voltage:
AC85-265V

灯具寿命/Lamp life:
>30000H

LED光色/LED color:
R/Y/B/G/W/WW/RGB

色彩效果/Colour effect:
全彩、单色/full colour, monochrome

防护等级/Protection grade:
IP65

环境温度/Environment temperature:
-30°C~+50°C

灯具材质/Lamp material:
铝材+钢化玻璃/AL+TG

线条尺寸图/Line size chart

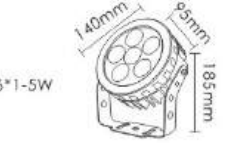

TGD-060

详细参数/SPECIFICATION

光源Light source:
著名品牌LED光源
常规功率Conventional power:
12W/24W

工作电压/Voltage:
AC85-265V

灯具寿命/Lamp life:
>30000H

LED光色/LED color:
R/Y/B/G/W/WW/RGB

色彩效果/Colour effect:
全彩、单色/full colour, monochrome

防护等级/Protection grade:
IP65

环境温度/Environment temperature:
-30°C~+50°C

灯具材质/Lamp material:
铝材+钢化玻璃/AL+TG

线条尺寸图/Line size chart

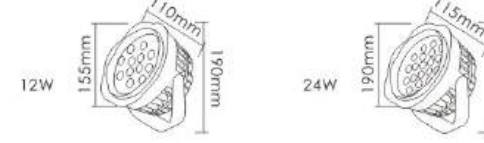

LED FLOOD LIGHT SERIES LED投光灯系列



TGD-061

详细参数/SPECIFICATION

光源Light source: 著名品牌LED光源
 常规功率Conventional power: 18W/24W/36W/54W
 工作电压/Voltage: AC85-265V
 灯具寿命/Lamp life: >30000H
 LED光色/LED color: R/Y/B/G/W/WW/RGB
 色彩效果/Colour effect: 全彩、单色/full colour, monochrome
 防护等级/Protection grade: IP65
 环境温度/Environment temperature: -30℃~+50℃
 灯具材质/Lamp material: 铝材+钢化玻璃/AL+TG

线条尺寸图/Line size chart



TGD-062

详细参数/SPECIFICATION

光源Light source: 著名品牌LED光源
 常规功率Conventional power: 9W/18W
 工作电压/Voltage: AC85-265V
 灯具寿命/Lamp life: >30000H
 LED光色/LED color: R/Y/B/G/W/WW/RGB
 色彩效果/Colour effect: 全彩、单色/full colour, monochrome
 防护等级/Protection grade: IP65
 环境温度/Environment temperature: -30℃~+50℃
 灯具材质/Lamp material: 铝材+钢化玻璃/AL+TG

线条尺寸图/Line size chart



TGD-063

详细参数/SPECIFICATION

光源Light source: 著名品牌LED光源
 常规功率Conventional power: 72W
 工作电压/Voltage: AC85-265V
 灯具寿命/Lamp life: >30000H
 LED光色/LED color: R/Y/B/G/W/WW/RGB
 色彩效果/Colour effect: 全彩、单色/full colour, monochrome
 防护等级/Protection grade: IP65
 环境温度/Environment temperature: -30℃~+50℃
 灯具材质/Lamp material: 铝材+钢化玻璃/AL+TG

线条尺寸图/Line size chart

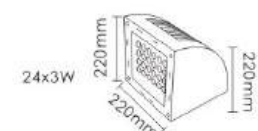

TGD-064

详细参数/SPECIFICATION

光源Light source: 著名品牌LED光源
 常规功率Conventional power: 18W
 工作电压/Voltage: AC85-265V
 灯具寿命/Lamp life: >30000H
 LED光色/LED color: R/Y/B/G/W/WW/RGB
 色彩效果/Colour effect: 全彩、单色/full colour, monochrome
 防护等级/Protection grade: IP65
 环境温度/Environment temperature: -30℃~+50℃
 灯具材质/Lamp material: 铝材+钢化玻璃/AL+TG

线条尺寸图/Line size chart

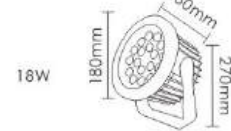

LED INSERT GROUND LAMP SERIES LED插地灯系列



CDD-001

详细参数/SPECIFICATION

光源/Light source: 著名品牌LED光源/famous brand LED light source
 常规功率/Conventional power: 5x2W/9x2W/12x2W/18x2W
 工作电压/Voltage: AC85-265V
 灯具寿命/Lamp life: >30000H
 LED光色/LED color: R/Y/B/G/W/WW/RGB
 色彩效果/Colour effect: 全彩、单色/full colour, monochrome
 控制方式/Control mode: 国际标准DMX512/international standard DMX512
 防护等级/Protection grade: IP65
 环境温度/Environment temperature: -30℃~+50℃
 发光角度/Light angle: 8° /15° /30° /45°

线条尺寸图/Line size chart



产品细节图/Product detail map



配光曲线图/Light distribution curve

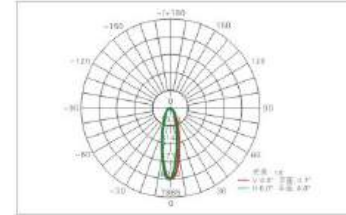

应用场景/Application scenario



工作电压、LED光色、安装方式等可非标定制
 Working voltage, LED light color, installation mode, etc, as non-standard custom

LED INSERT GROUND LAMP SERIES
LED插地灯系列



CDD-002

详细参数/SPECIFICATION

光源/Light source:	著名品牌LED光源/famous brand LED light source
常规功率/Conventional power:	3W/7W/9W/12W
工作电压/Voltage:	AC85-265V
灯具寿命/Lamp life:	≥30000H
LED光色/LED color:	R/Y/B/G/W/WW/RGB
色彩效果/Colour effect:	全彩、单色/full colour, monochrome
控制方式/Control mode:	国际标准DMX512/International standard DMX512
防护等级/Protection grade:	IP65
环境温度/Environment temperature:	-30℃~+50℃
发光角度/Light angle:	15° /30° /45° /60° /90° /120°

线条尺寸图/Line size chart 产品细节图/Product detail map 配光曲线图/Light distribution curve 应用场景/Application scenario

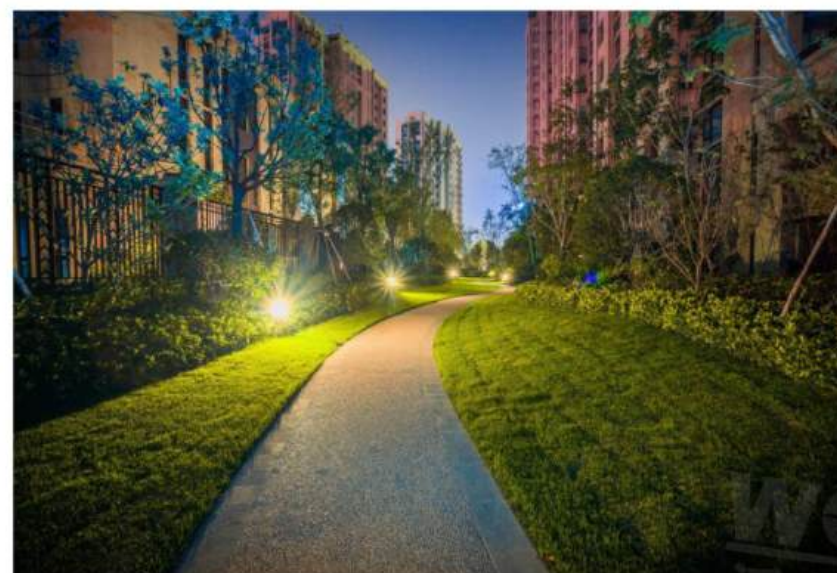

工作电压、LED光色、安装方式等可非标定制
Working voltage, LED light color, installation mode, etc, as non-standard custom

LED INSERT GROUND LAMP SERIES
LED插地灯系列



CDD-003

详细参数/SPECIFICATION

光源/Light source:	著名品牌LED光源/famous brand LED light source
常规功率/Conventional power:	3W/5W/6W/7W/9W/15W
工作电压/Voltage:	AC85-265V
灯具寿命/Lamp life:	≥30000H
LED光色/LED color:	R/Y/B/G/W/WW/RGB
色彩效果/Colour effect:	全彩、单色/full colour, monochrome
控制方式/Control mode:	国际标准DMX512/International standard DMX512
防护等级/Protection grade:	IP65
环境温度/Environment temperature:	-30℃~+50℃
发光角度/Light angle:	15° /30° /45° /60° /90° /120°

线条尺寸图/Line size chart 产品细节图/Product detail map 配光曲线图/Light distribution curve 应用场景/Application scenario



应用场所: 建筑物周围、台阶、人行道、屋顶花园、城市广场、车辆通道、小径、雕塑、矮小树林、河流防护栏等照射
Application places: Buildings, steps, sidewalks, roof gardens, city squares, vehicle corridors, trails, sculptures, small trees, river barriers, etc



产品特点

- LED直接与外壳紧密相接,通过全铝外壳散热翼与空气对流散热,灯壳采用铝合金,可以有效散热并保证了光源寿命,高强度钢化玻璃与灯体的完美结合,使得灯具可以在高湿度中使用;
- 灯体采用老化硅橡胶密封带,表面经阳极氧化和喷塑处理,耐腐蚀,整体灯具符合IP65标准,适合户外恶劣环境中使用,多种角度透镜选择,适用更广泛;
- 采用高纯度铝反射罩,有效提高了反射率,并确保了光通量输出。针对性地将LED发出地光控制在需要范围内,提高了灯具出光效果的均匀性和光能的利用率,凸现了LED灯具明显的节能优势;
- LED光源隧道灯不存在启动延迟问题,通电可立即正常工作,解决了传统灯具漫长的启动过程,实现了瞬时启动和再启动;

适用范围

广泛应用于公路、铁路、地铁、地下停车场、隧道以及其它地下通道的照明,车间、大型仓库,体育场馆及各类厂区、工程施工等场所大面积泛光照明,也可用于城市景观、广告牌、建筑立面等夜景照明。

Product features

- Pieces LED closely connect directly with the shell, through the whole aluminum shell heat dissipation wing and air convection, the lamp shell using aluminum alloy, can effective heat dissipation and guarantee the working life of the light source. High strength tempered glass with the perfect combination of the lamp body, make the lamps and lanterns can be used in high humidity;
- The lamp body adopts aging resistant silicon rubber sealing strip, anodic oxidation and coating on the surface, anticorrosive, the overall IP65 standard lamps and lanterns, used for outdoor environment, a variety of Angle lens selection, applies more widely;
- Mixer adopts high purity aluminum reflector, effectively improve the reflectivity, and ensure that the luminous flux output. Pointed to the LED a gigantic control within the scope of the need, improves the uniformity of light effects of lamps and lanterns and light energy utilization, highlights the LED lamps and lanterns is obvious energy-saving advantages;
- Pieces LED light tunnel light there is no startup delay problem, electricity can immediately work, solve the traditional lamps and lanterns is long to start the process. Realize the instantaneous startup and restart;

Scope of application

Widely used in highway, railway, subway, underground parking lots, tunnels and other underground tunnel lighting, workshop, large warehouse, sports venues and all kinds of places such as large area flood lighting factory, engineering construction, can also be used for city landscape, billboard, building facade illumination, etc.

选材·解析



光学透镜

采用全新技术PMMA光学透镜，透光率好，光线均匀，光效一致性好。



高亮LED芯片

采用高亮芯片，亮度高、低功耗、超高流明，在各种气候条件下仍能长时间稳定工作，寿命更长。



优质铝材灯体

采用优质铝材，表面喷涂阳极氧化处理，抗腐蚀性强，不易开裂，抗压能力好。



防水可调驱动

采用明纬驱动电源，带IC智能控制，确保电流稳定，开路、短路、过压、过流自动保护。



国标全铜线

采用优质国际三芯铜线，导电性更强，加厚绝缘环保材料，专业绕流、防雷击、阻燃等特性，线材柔软不易折断。



空气对流散热器

一体化加厚精工压铸纯铝，工业级散热，强对流设计，导热性更佳，完美解决散热问题，保护光源使用寿命。



可调固定支架

采用优质铝材，可180度调节，操作简单方便，满足更多安装需求。



不锈钢螺丝

采用不锈钢材质，高强度不易滑，不易腐蚀生锈，防损坏，不易脱落，加强灯体的稳定性。



SDD-DL01

详细参数/SPECIFICATION

光源/Light source:	著名品牌LED光源/famous brand LED light source
常规功率/Conventional power:	50W/100W/150W/200W/250W
工作电压/Voltage:	AC85-265V
灯具寿命/Lamp life:	≥30000H
LED光色/LED color:	W/WW
色彩效果/Colour effect:	单色/monochrome
灯具材质/Material:	铝材/AL
防护等级/Protection grade:	IP65
环境温度/Environment temperature:	-30℃~+50℃
发光角度/Light angle:	60°/90°



线条尺寸图/Line size chart

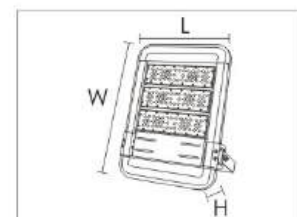

产品细节图/Product detail map



配光曲线图/Light distribution curve

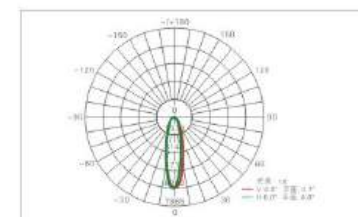

应用场景/Application scenario



应用场所: 铁路、地铁、地下停车场、隧道、体育场以及其他地下通道的照明。
Application places: Railways, subways, underground parking lots, tunnels, stadiums and other underground tunnels.



SDD-HZ02

详细参数/SPECIFICATION

光源/Light source:	著名品牌LED光源/famous brand LED light source
常规功率/Conventional power:	50W/100W/150W/200W/250W/300W
工作电压/Voltage:	AC85-265V
灯具寿命/Lamp life:	≥30000H
LED光色/LED color:	W/WW
色彩效果/Colour effect:	单色/monochrome
灯具材质/Material:	铝材/AL
防护等级/Protection grade:	IP65
环境温度/Environment temperature:	-30℃~+50℃
发光角度/Light angle:	60°/90°

线条尺寸图/Line size chart

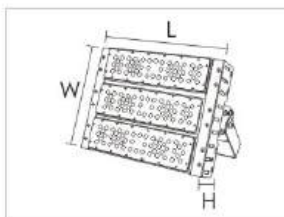

产品细节图/Product detail map



配光曲线图/Light distribution curve

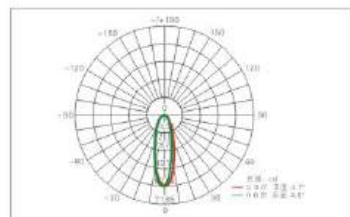

应用场景/Application scenario

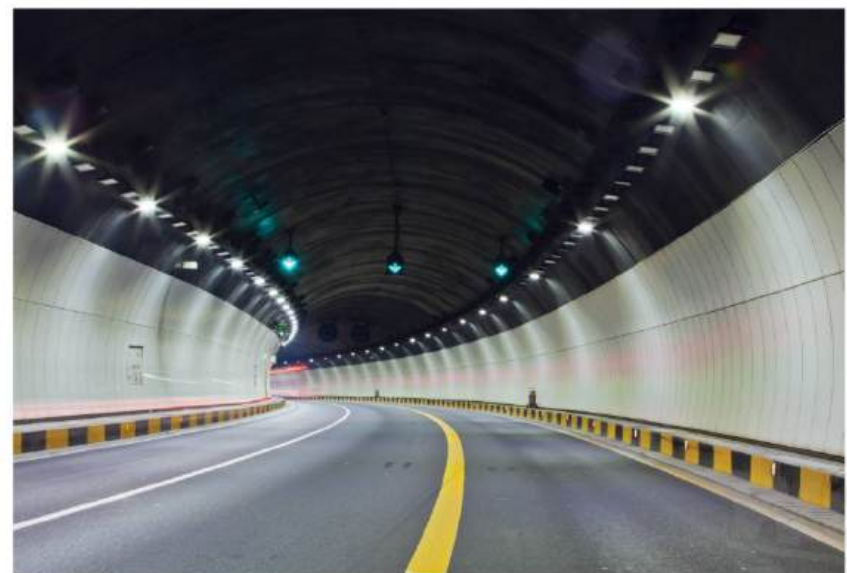

应用场所: 铁路、地铁、地下停车场、隧道、体育场以及其他地下通道的照明。
Application places: Railways, subways, underground parking lots, tunnels, stadiums and other underground tunnels.



SDD-DL03

详细参数/SPECIFICATION

光源/Light source:	著名品牌LED光源/famous brand LED light source
常规功率/Conventional power:	56W/112W/168W/224W/280W/336W
工作电压/Voltage:	AC85-265V
灯具寿命/Lamp life:	≥30000H
LED光色/LED color:	W/WW
色彩效果/Colour effect:	单色/monochrome
灯具材质/Material:	铝材/AL
防护等级/Protection grade:	IP65
环境温度/Environment temperature:	-30℃~+50℃
发光角度/Light angle:	60°/90°

线条尺寸图/Line size chart

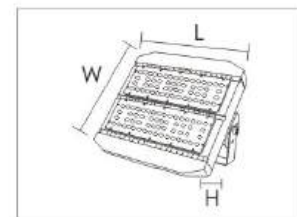

产品细节图/Product detail map



配光曲线图/Light distribution curve

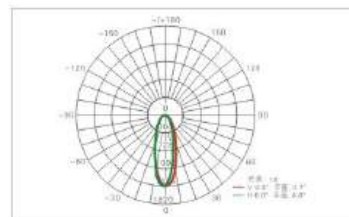

应用场景/Application scenario

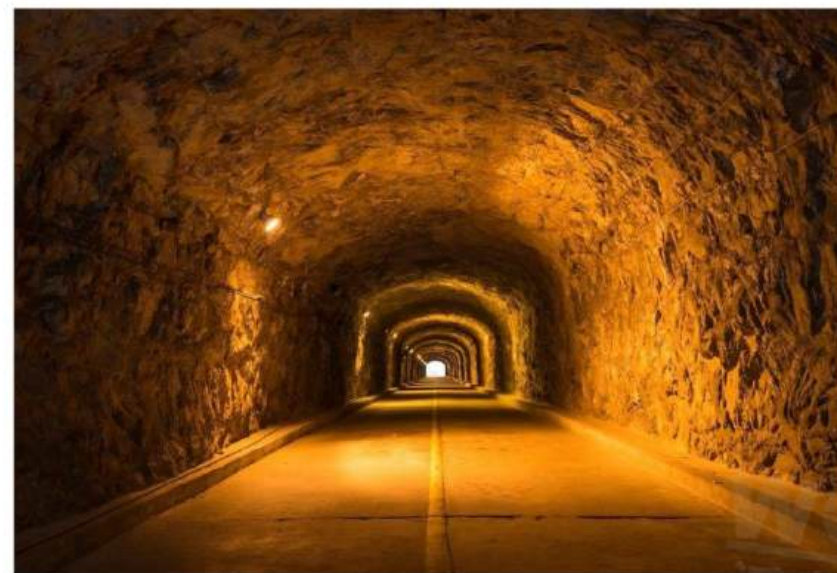

应用场所: 铁路、地铁、地下停车场、隧道、体育场以及其他地下通道的照明。
Application places: Railways, subways, underground parking lots, tunnels, stadiums and other underground tunnels.

LED TUNNEL LAMP SERIES
LED隧道灯系列



SDD-KR04



SDD-KR05



SDD-YH06



详细参数/SPECIFICATION

光源Light source:	著名品牌LED光源/famous brand LED light source
常规功率Conventional power:	50W/100W/150W
工作电压/Voltage:	AC85-265V
灯具寿命/Lamp life:	>30000H
LED光色/LED color:	W/WW
色彩效果/Colour effect:	单色/Monochrome
防护等级/Protection grade:	IP65
环境温度/Environment temperature:	-30°C~+50°C
发光角度/Light angle:	60° /90°

详细参数/SPECIFICATION

光源Light source:	著名品牌LED光源/famous brand LED light source
常规功率Conventional power:	50W/100W/150W
工作电压/Voltage:	AC85-265V
灯具寿命/Lamp life:	>30000H
LED光色/LED color:	W/WW
色彩效果/Colour effect:	单色/Monochrome
防护等级/Protection grade:	IP65
环境温度/Environment temperature:	-30°C~+50°C
发光角度/Light angle:	60° /90°

详细参数/SPECIFICATION

光源Light source:	著名品牌LED光源/famous brand LED light source
常规功率Conventional power:	50W/100W/150W/200W
工作电压/Voltage:	AC85-265V
灯具寿命/Lamp life:	>30000H
LED光色/LED color:	W/WW
色彩效果/Colour effect:	单色/Monochrome
防护等级/Protection grade:	IP65
环境温度/Environment temperature:	-30°C~+50°C
发光角度/Light angle:	60° /90°

LED TUNNEL LAMP SERIES
LED隧道灯系列



SDD-007



SDD-QT08



SDD-CP09



详细参数/SPECIFICATION

光源Light source:	著名品牌LED光源/famous brand LED light source
常规功率Conventional power:	30W/60W/90W/120W/150W
工作电压/Voltage:	AC85-265V
灯具寿命/Lamp life:	>30000H
LED光色/LED color:	W/WW
色彩效果/Colour effect:	单色/Monochrome
防护等级/Protection grade:	IP65
环境温度/Environment temperature:	-30°C~+50°C
发光角度/Light angle:	60° /90°

详细参数/SPECIFICATION

光源Light source:	著名品牌LED光源/famous brand LED light source
常规功率Conventional power:	50W/75W/100W/125W
工作电压/Voltage:	AC85-265V
灯具寿命/Lamp life:	>30000H
LED光色/LED color:	W/WW
色彩效果/Colour effect:	单色/Monochrome
防护等级/Protection grade:	IP65
环境温度/Environment temperature:	-30°C~+50°C
发光角度/Light angle:	60° /90°

详细参数/SPECIFICATION

光源Light source:	著名品牌LED光源/famous brand LED light source
常规功率Conventional power:	60W/90W/120W/180W
工作电压/Voltage:	AC85-265V
灯具寿命/Lamp life:	>30000H
LED光色/LED color:	W/WW
色彩效果/Colour effect:	单色/Monochrome
防护等级/Protection grade:	IP65
环境温度/Environment temperature:	-30°C~+50°C
发光角度/Light angle:	60° /90°

LED TUNNEL LAMP SERIES
LED隧道灯系列



SDD-010

详细参数/SPECIFICATION

光源Light source:
著名品牌LED光源
常规功率Conventional power:
100W/140W/200W
工作电压/Voltage:
AC85-265V
灯具寿命/Lamp life:
>30000H
LED光色/LED color:
W/WW
色彩效果/Colour effect:
单色/Monochrome
防护等级/Protection grade:
IP65
环境温度/Environment temperature:
-30℃~+50℃
灯具材质/Lamp material:
铝材+钢化玻璃/AL+TG

线条尺寸图/Line size chart

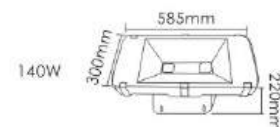

SDD-011

详细参数/SPECIFICATION

光源Light source:
著名品牌LED光源
常规功率Conventional power:
40W
工作电压/Voltage:
AC85-265V
灯具寿命/Lamp life:
>30000H
LED光色/LED color:
W/WW
色彩效果/Colour effect:
单色/Monochrome
防护等级/Protection grade:
IP65
环境温度/Environment temperature:
-30℃~+50℃
灯具材质/Lamp material:
铝材+钢化玻璃/AL+TG

线条尺寸图/Line size chart

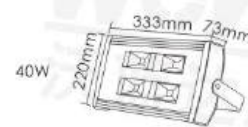

SDD-012

详细参数/SPECIFICATION

光源Light source:
著名品牌LED光源
常规功率Conventional power:
60W
工作电压/Voltage:
AC85-265V
灯具寿命/Lamp life:
>30000H
LED光色/LED color:
W/WW
色彩效果/Colour effect:
单色/Monochrome
防护等级/Protection grade:
IP65
环境温度/Environment temperature:
-30℃~+50℃
灯具材质/Lamp material:
铝材/AL

线条尺寸图/Line size chart

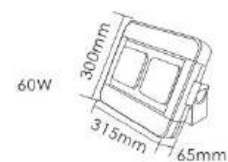

SDD-013

详细参数/SPECIFICATION

光源Light source:
著名品牌LED光源
常规功率Conventional power:
100W
工作电压/Voltage:
AC85-265V
灯具寿命/Lamp life:
>30000H
LED光色/LED color:
W/WW
色彩效果/Colour effect:
单色/Monochrome
防护等级/Protection grade:
IP65
环境温度/Environment temperature:
-30℃~+50℃
灯具材质/Lamp material:
铝材+钢化玻璃/AL+TG

线条尺寸图/Line size chart

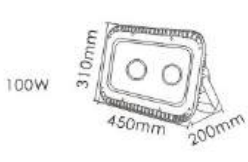

LED TUNNEL LAMP SERIES
LED隧道灯系列



SDD-014

详细参数/SPECIFICATION

光源Light source:
著名品牌LED光源
常规功率Conventional power:
150W
工作电压/Voltage:
AC85-265V
灯具寿命/Lamp life:
>30000H
LED光色/LED color:
W/WW
色彩效果/Colour effect:
单色/Monochrome
防护等级/Protection grade:
IP65
环境温度/Environment temperature:
-30℃~+50℃
灯具材质/Lamp material:
铝材/AL

线条尺寸图/Line size chart



SDD-015

详细参数/SPECIFICATION

光源Light source:
著名品牌LED光源
常规功率Conventional power:
120W
工作电压/Voltage:
AC85-265V
灯具寿命/Lamp life:
>30000H
LED光色/LED color:
W/WW
色彩效果/Colour effect:
单色/Monochrome
防护等级/Protection grade:
IP65
环境温度/Environment temperature:
-30℃~+50℃
灯具材质/Lamp material:
铝材/AL

线条尺寸图/Line size chart



SDD-016

详细参数/SPECIFICATION

光源Light source:
著名品牌LED光源
常规功率Conventional power:
84W
工作电压/Voltage:
AC85-265V
灯具寿命/Lamp life:
>30000H
LED光色/LED color:
W/WW
色彩效果/Colour effect:
单色/Monochrome
防护等级/Protection grade:
IP65
环境温度/Environment temperature:
-30℃~+50℃
灯具材质/Lamp material:
铝材+钢化玻璃/AL+TG

线条尺寸图/Line size chart

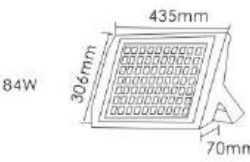

SDD-017

详细参数/SPECIFICATION

光源Light source:
著名品牌LED光源
常规功率Conventional power:
75W/90W/120W
工作电压/Voltage:
AC85-265V
灯具寿命/Lamp life:
>30000H
LED光色/LED color:
W/WW
色彩效果/Colour effect:
单色/Monochrome
防护等级/Protection grade:
IP65
环境温度/Environment temperature:
-30℃~+50℃
灯具材质/Lamp material:
铝材+钢化玻璃/AL+TG

线条尺寸图/Line size chart

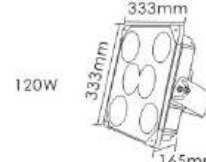



WOYLD
沃蓝达照明



产品特点

- 灯具外壳均采用优质铝材，表面喷漆或阳极氧化处理，灯体美观精致，散热性能优良，承受高强度机械冲击和震动，不易破碎；
- 采用低耗高效进口光源，光通量高、显色性强、光色柔和、无眩光、发热量低，无热辐射
- 灯体采用钢化玻璃及硅胶密封，内部环氧树脂灌胶，确保灯具卓越的防水性能；
- 绿色环保：不含汞、铅等有害金属元素，不含红、紫外线，无污染；
- 灯体内散热铝基板厚实，散热优良，确保灯具寿命更长久，可达到5万小时；
- 灯具采用PMMA光学级透镜，可选角度15° 30° 45° 60° 120°；
- 内置恒流AC85V-AC265V宽电压驱动，确保灯具在不同国家、区域或电压不稳时可正常工作。

适用范围

广泛应用于高速公路、主干道、支干道、支路、公园、广场、园林道路、步行街、停车场、街道、小区、工厂、学校、各种住宅小区、庭院等道路照明。

Product features

- Lamps shell adopts the high quality aluminum, the surface spray paint or anodic oxidation treatment, the lamp body beautiful and delicate, good heat dissipation performance and withstand high strength mechanical shock and vibration, not easy and broken;
- Mixer imported low energy efficient light source, high luminous flux, strong color, soft light, no glare, low calorific value, no thermal radiation
- Lamp body adopts toughened glass and silicon seal, internal epoxy resin glue, to ensure superior waterproof performance of lamps and lanterns;
- Pieces of green environmental protection: no mercury, lead and other harmful metal elements, including red, ultraviolet light, free from contamination
- Mixer lamp body heat dissipation aluminum plate thick, good heat dissipation, ensure lamps and lanterns of longer life, can reach 50000 hours;
- Lamps and lanterns of mixer adopt PMMA optical lens, optional Angle is 15° to 30° 45° to 60° , 120° ;
- Built-in constant-current AC85V pieces - AC265V wide voltage drive, ensure lamps and lanterns in different national, regional or voltage instability when working.

Scope of application

Widely used in highway, the main road, road, branch, park, square, garden road, pedestrian street, car parks, streets, communities, factories, schools, all kinds of residential area, garden road lighting, etc.

WOYLD
沃蓝达照明

WOYLD
沃蓝达
139

选材·解析

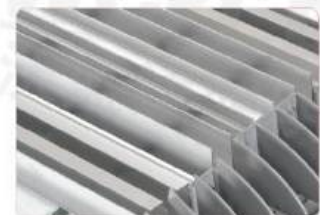

空气对流散热器

强对流设计一体化散热器，散热效果出众，有效保护灯珠温度，延长灯珠使用寿命。



光学透镜

采用新技术PMMA光学透镜，透光率好，光线均匀，光效一致性好。



高亮LED芯片

采用高亮芯片，亮度高，功耗低，超高流明，在各种气候条件下仍能长时间稳定工作，寿命更长。



高品质铝材灯体

采用优质铝材，表面喷涂阳极氧化处理，抗腐蚀性强，不易开裂，抗压能力好。



不锈钢螺丝

不锈钢材质，高强度不易滑，不易腐蚀生锈，防损坏，不易脱落，加强灯体的稳定性。



防水可调驱动

明纬驱动电源，带IC智能控制，确保电流稳定，开路、短路、过压、欠压、过载自动保护。



国标全铜线

优质国际三芯铜线，导电性更强，加厚绝缘环保材料，专业稳流、防雷击、阻燃等特性，线材柔软不易折断。



灯杆接口

标准60mm常用灯杆接口，适合更多环境使用，维修、更换更方便。



LD-YH01

详细参数/SPECIFICATION

光源/Light source:	著名品牌LED光源/famous brand LED light source
常规功率/Conventional power:	50W/100W/150W/200W/250W/300W
工作电压/Voltage:	AC85-265V
灯具寿命/Lamp life:	≥30000H
LED光色/LED color:	W/WW
色彩效果/Colour effect:	单色/Monochrome
灯具材质/Material:	铝材/AL
防护等级/Protection grade:	IP65
环境温度/Environment temperature:	-30℃~+50℃
发光角度/Light angle:	120°



线条尺寸图/Line size chart

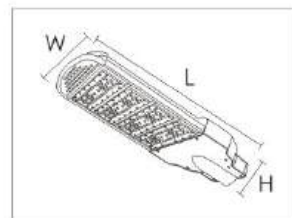

产品细节图/Product detail map



配光曲线图/Light distribution curve

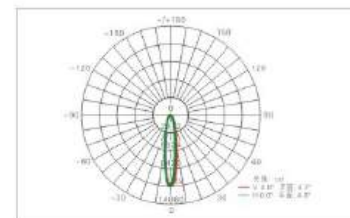

应用场景/Application scenario



应用场所: 高速公路、主干道、支干道、园林道路、各种住宅小区等道路照明。
Application places: Highways, main roads, highways, garden roads, various residential communities and other road lighting



LD-HZ02



详细参数/SPECIFICATION

光源/Light source:	著名品牌LED光源/famous brand LED light source
常规功率/Conventional power:	50W/100W/150W/200W/250W/300W
工作电压/Voltage:	AC85-265V
灯具寿命/Lamp life:	≥30000H
LED光色/LED color:	W/WW
色彩效果/Colour effect:	单色/Monochrome
灯具材质/Material:	铝材/AL
防护等级/Protection grade:	IP65
环境温度/Environment temperature:	-30℃~+50℃
发光角度/Light angle:	120°

线条尺寸图/Line size chart

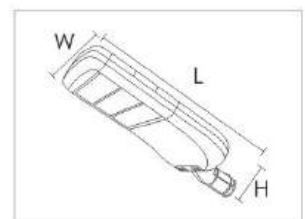

产品细节图/Product detail map



配光曲线图/Light distribution curve

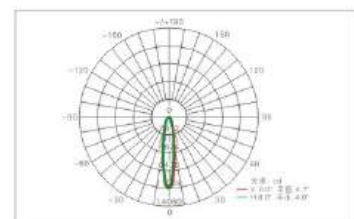

应用场景/Application scenario



50W L550xW340xH120mm 100W L630xW340xH120mm 150W L710xW340xH120mm 200W L790xW340xH120mm 250W L870xW340xH120mm 300W L950xW340xH120mm

应用场所: 高速公路、主干道、支干道、园林道路、各种住宅小区等道路照明。
Application places: Highways, main roads, highways, garden roads, various residential communities and other road lighting



LD-HZ03



详细参数/SPECIFICATION

光源/Light source:	著名品牌LED光源/famous brand LED light source
常规功率/Conventional power:	50W/100W/150W/200W/250W/300W
工作电压/Voltage:	AC85-265V
灯具寿命/Lamp life:	≥30000H
LED光色/LED color:	W/WW
色彩效果/Colour effect:	单色/Monochrome
灯具材质/Material:	铝材/AL
防护等级/Protection grade:	IP65
环境温度/Environment temperature:	-30℃~+50℃
发光角度/Light angle:	120°

线条尺寸图/Line size chart

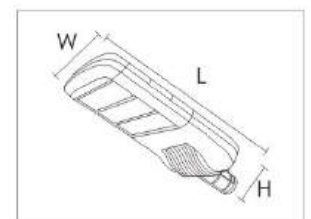

产品细节图/Product detail map



配光曲线图/Light distribution curve

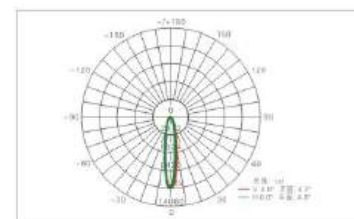

应用场景/Application scenario

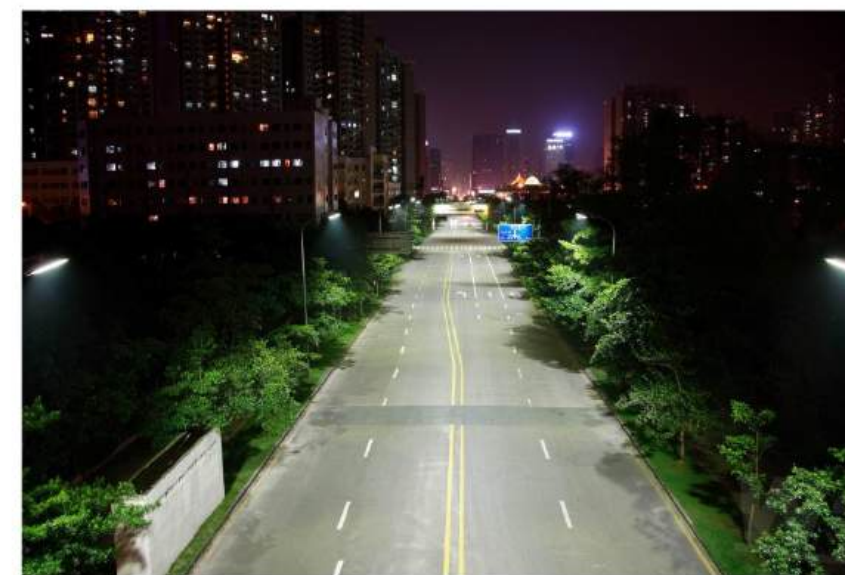

50W L495xW340xH120mm 100W L575xW340xH120mm 150W L655xW340xH120mm 200W L735xW340xH120mm 250W L815xW340xH120mm 300W L895xW340xH120mm

应用场所: 高速公路、主干道、支干道、园林道路、各种住宅小区等道路照明。
Application places: Highways, main roads, highways, garden roads, various residential communities and other road lighting



LD-DL04

详细参数/SPECIFICATION

光源/Light source:	著名品牌LED光源/famous brand LED light source
常规功率/Conventional power:	50W/100W/150W/200W/250W/300W
工作电压/Voltage:	AC85-265V
灯具寿命/Lamp life:	≥30000H
LED光色/LED color:	W/WW
色彩效果/Colour effect:	单色/Monochrome
灯具材质/Material:	铝材/AL
防护等级/Protection grade:	IP65
环境温度/Environment temperature:	-30℃~+50℃
发光角度/Light angle:	120°



线条尺寸图/Line size chart

产品细节图/Product detail map

配光曲线图/Light distribution curve

应用场景/Application scenario

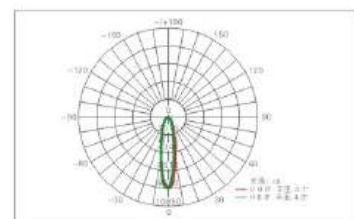
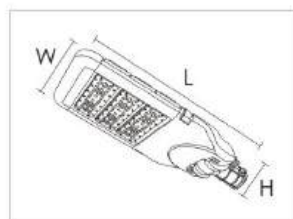

应用场所: 高速公路、主干道、支干道、园林道路、各种住宅小区等道路照明。
Application places: Highways, main roads, highways, garden roads, various residential communities and other road lighting



LD-005

详细参数/SPECIFICATION

光源/Light source:	著名品牌LED光源/famous brand LED light source
常规功率/Conventional power:	50W/100W/150W/200W/250W/300W
工作电压/Voltage:	AC85-265V
灯具寿命/Lamp life:	≥30000H
LED光色/LED color:	W/WW
色彩效果/Colour effect:	单色/Monochrome
灯具材质/Material:	铝材/AL
防护等级/Protection grade:	IP65
环境温度/Environment temperature:	-30℃~+50℃
发光角度/Light angle:	120°



线条尺寸图/Line size chart

产品细节图/Product detail map

配光曲线图/Light distribution curve

应用场景/Application scenario

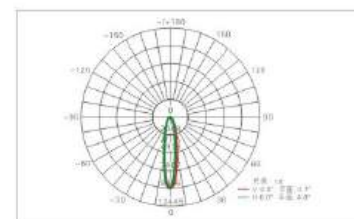
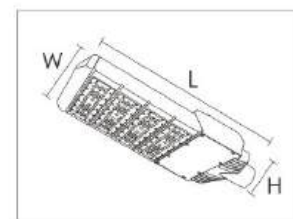

应用场所: 高速公路、主干道、支干道、园林道路、各种住宅小区等道路照明。
Application places: Highways, main roads, highways, garden roads, various residential communities and other road lighting



LD-DL06

详细参数/SPECIFICATION

光源/Light source:	著名品牌LED光源/famous brand LED light source
常规功率/Conventional power:	100W/150W/200W/250W/300W
工作电压/Voltage:	AC85-265V
灯具寿命/Lamp life:	≥30000H
LED光色/LED color:	W/WW
色彩效果/Colour effect:	单色/Monochrome
灯具材质/Material:	铝材/AL
防护等级/Protection grade:	IP65
环境温度/Environment temperature:	-30℃~+50℃
发光角度/Light angle:	120°



线条尺寸图/Line size chart

产品细节图/Product detail map

配光曲线图/Light distribution curve

应用场景/Application scenario

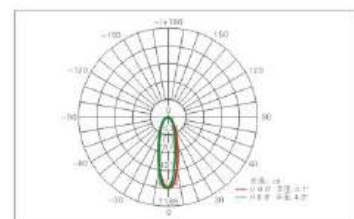
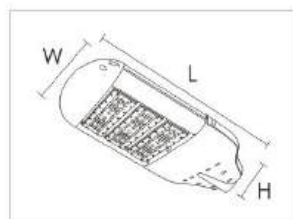

应用场所: 高速公路、主干道、支干道、园林道路、各种住宅小区等道路照明。
Application places: Highways, main roads, highways, garden roads, various residential communities and other road lighting



LD-DL07

详细参数/SPECIFICATION

光源/Light source:	著名品牌LED光源/famous brand LED light source
常规功率/Conventional power:	50W/100W/150W/200W/250W/300W
工作电压/Voltage:	AC85-265V
灯具寿命/Lamp life:	≥30000H
LED光色/LED color:	W/WW
色彩效果/Colour effect:	单色/Monochrome
灯具材质/Material:	铝材/AL
防护等级/Protection grade:	IP65
环境温度/Environment temperature:	-30℃~+50℃
发光角度/Light angle:	120°



线条尺寸图/Line size chart

产品细节图/Product detail map

配光曲线图/Light distribution curve

应用场景/Application scenario

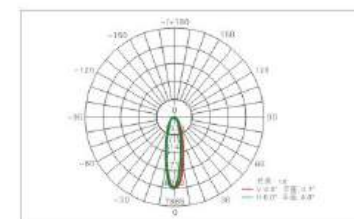
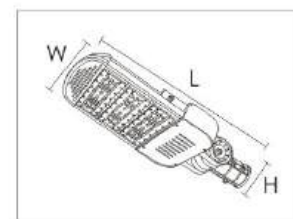

应用场所: 高速公路、主干道、支干道、园林道路、各种住宅小区等道路照明。
Application places: Highways, main roads, highways, garden roads, various residential communities and other road lighting



LD-DL08

详细参数/SPECIFICATION

光源/Light source:	著名品牌LED光源/famous brand LED light source
常规功率/Conventional power:	50W/100W/150W/200W/250W/300W/350W
工作电压/Voltage:	AC85-265V
灯具寿命/Lamp life:	≥30000H
LED光色/LED color:	W/WW
色彩效果/Colour effect:	单色/Monochrome
灯具材质/Material:	铝材/AL
防护等级/Protection grade:	IP65
环境温度/Environment temperature:	-30℃~+50℃
发光角度/Light angle:	120°



线条尺寸图/Line size chart

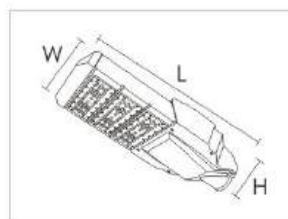

产品细节图/Product detail map



配光曲线图/Light distribution curve

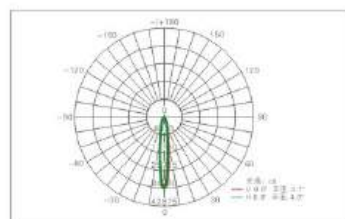

应用场景/Application scenario



应用场所: 高速公路、主干道、支干道、园林道路、各种住宅小区等道路照明。
Application places: Highways, main roads, highways, garden roads, various residential communities and other road lighting



LD-DL09

详细参数/SPECIFICATION

光源/Light source:	著名品牌LED光源/famous brand LED light source
常规功率/Conventional power:	56W/112W/168W/224W/280W/336W
工作电压/Voltage:	AC85-265V
灯具寿命/Lamp life:	≥30000H
LED光色/LED color:	W/WW
色彩效果/Colour effect:	单色/Monochrome
灯具材质/Material:	铝材/AL
防护等级/Protection grade:	IP65
环境温度/Environment temperature:	-30℃~+50℃
发光角度/Light angle:	120°



线条尺寸图/Line size chart

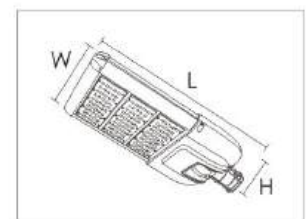

产品细节图/Product detail map



配光曲线图/Light distribution curve

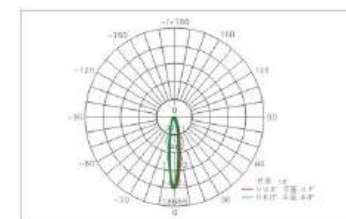

应用场景/Application scenario



应用场所: 高速公路、主干道、支干道、园林道路、各种住宅小区等道路照明。
Application places: Highways, main roads, highways, garden roads, various residential communities and other road lighting



LD-DL10

详细参数/SPECIFICATION

光源/Light source:	著名品牌LED光源/famous brand LED light source
常规功率/Conventional power:	100W/150W/200W/250W
工作电压/Voltage:	AC85-265V
灯具寿命/Lamp life:	≥30000H
LED光色/LED color:	W/WW
色彩效果/Colour effect:	单色/Monochrome
灯具材质/Material:	铝材/AL
防护等级/Protection grade:	IP65
环境温度/Environment temperature:	-30℃~+50℃
发光角度/Light angle:	120°



线条尺寸图/Line size chart

产品细节图/Product detail map

配光曲线图/Light distribution curve

应用场景/Application scenario

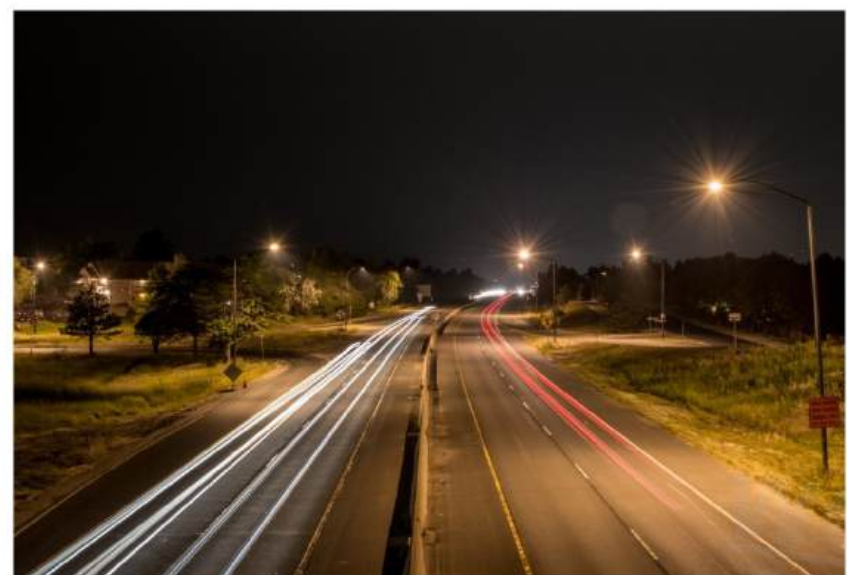
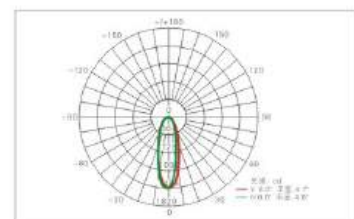
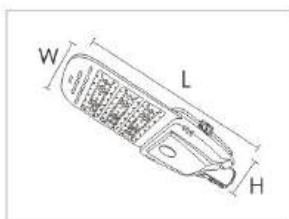

应用场所: 高速公路、主干道、支干道、园林道路、各种住宅小区等道路照明。
Application places: Highways, main roads, highways, garden roads, various residential communities and other road lighting



LD-DL11

详细参数/SPECIFICATION

光源/Light source:	著名品牌LED光源/famous brand LED light source
常规功率/Conventional power:	100W/150W/200W/250W/300W
工作电压/Voltage:	AC85-265V
灯具寿命/Lamp life:	≥30000H
LED光色/LED color:	W/WW
色彩效果/Colour effect:	单色/Monochrome
灯具材质/Material:	铝材/AL
防护等级/Protection grade:	IP65
环境温度/Environment temperature:	-30℃~+50℃
发光角度/Light angle:	120°



线条尺寸图/Line size chart

产品细节图/Product detail map

配光曲线图/Light distribution curve

应用场景/Application scenario

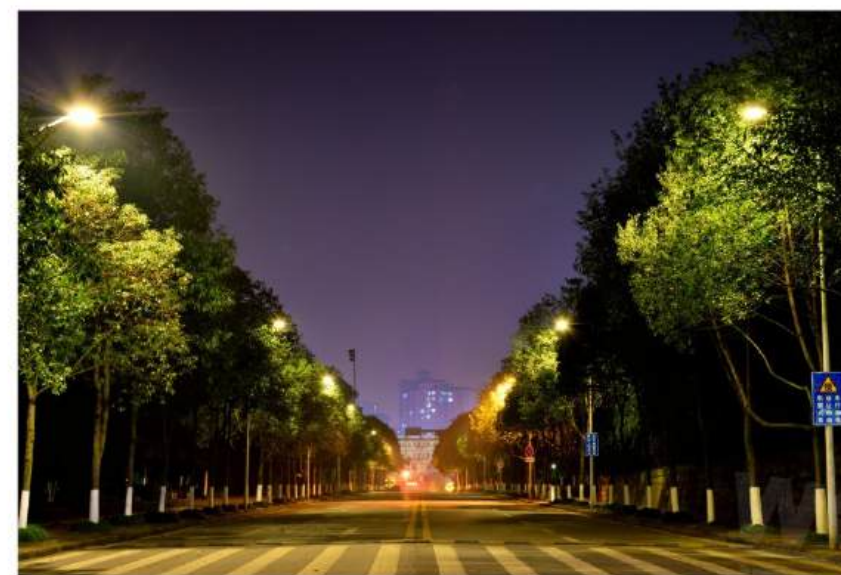
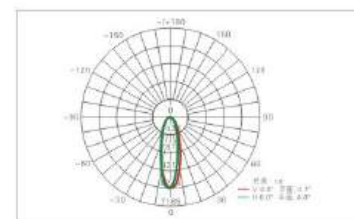
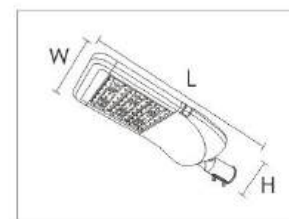

应用场所: 高速公路、主干道、支干道、园林道路、各种住宅小区等道路照明。
Application places: Highways, main roads, highways, garden roads, various residential communities and other road lighting



LD-YX12

详细参数/SPECIFICATION

光源/Light source:	著名品牌LED光源/famous brand LED light source
常规功率/Conventional power:	20W//40W/60W/80W/100W/120W/150W/200W
工作电压/Voltage:	AC85-265V
灯具寿命/Lamp life:	≥30000H
LED光色/LED color:	W/WW
色彩效果/Colour effect:	单色/Monochrome
灯具材质/Material:	铝材+钢化玻璃/AL+TG
防护等级/Protection grade:	IP65
环境温度/Environment temperature:	-30℃~+50℃
发光角度/Light angle:	30° /60° /90° /120°



线条尺寸图/Line size chart

产品细节图/Product detail map

配光曲线图/Light distribution curve

应用场景/Application scenario

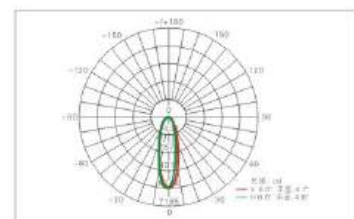
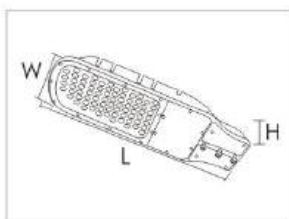

应用场所: 高速公路、主干道、支干道、园林道路、各种住宅小区等道路照明。
Application places: Highways, main roads, highways, garden roads, various residential communities and other road lighting



LD-XH13

详细参数/SPECIFICATION

光源/Light source:	著名品牌LED光源/famous brand LED light source
常规功率/Conventional power:	50W//100W/150W/200W/250W
工作电压/Voltage:	AC85-265V
灯具寿命/Lamp life:	≥30000H
LED光色/LED color:	W/WW
色彩效果/Colour effect:	单色/Monochrome
灯具材质/Material:	铝材/AL
防护等级/Protection grade:	IP65
环境温度/Environment temperature:	-30℃~+50℃
发光角度/Light angle:	90° /140°



线条尺寸图/Line size chart

产品细节图/Product detail map

配光曲线图/Light distribution curve

应用场景/Application scenario

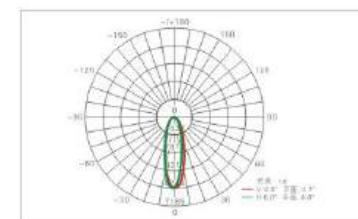
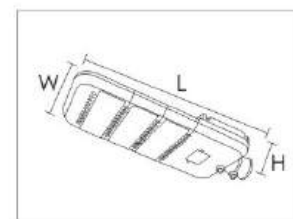

应用场所: 高速公路、主干道、支干道、园林道路、各种住宅小区等道路照明。
Application places: Highways, main roads, highways, garden roads, various residential communities and other road lighting

LED STREET LAMP SERIES
LED路灯系列



LD-KR14



LD-KR15

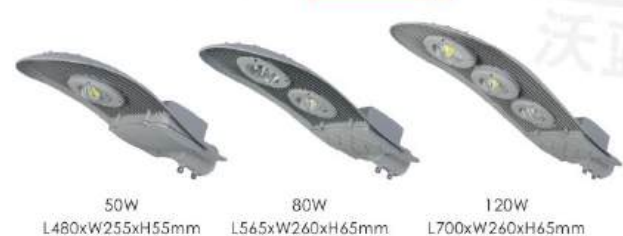

LD-YH16



详细参数/SPECIFICATION

光源Light source:	著名品牌LED光源/famous brand LED light source
常规功率Conventional power:	50W/100W/150W
工作电压/Voltage:	AC85-265V
灯具寿命/Lamp life:	>30000H
LED光色/LED color:	W/WW
色彩效果/Colour effect:	单色/Monochrome
防护等级/Protection grade:	IP65
环境温度/Environment temperature:	-30°C~+50°C
发光角度/Light angle:	120°

详细参数/SPECIFICATION

光源Light source:	著名品牌LED光源/famous brand LED light source
常规功率Conventional power:	50W/80W/120W
工作电压/Voltage:	AC85-265V
灯具寿命/Lamp life:	>30000H
LED光色/LED color:	W/WW
色彩效果/Colour effect:	单色/Monochrome
防护等级/Protection grade:	IP65
环境温度/Environment temperature:	-30°C~+50°C
发光角度/Light angle:	120°

详细参数/SPECIFICATION

光源Light source:	著名品牌LED光源/famous brand LED light source
常规功率Conventional power:	60W/100W/150W
工作电压/Voltage:	AC85-265V
灯具寿命/Lamp life:	>30000H
LED光色/LED color:	W/WW
色彩效果/Colour effect:	单色/Monochrome
防护等级/Protection grade:	IP65
环境温度/Environment temperature:	-30°C~+50°C
发光角度/Light angle:	120°

LED STREET LAMP SERIES
LED路灯系列



LD-DL17



LD-DL18



LD-DL19



详细参数/SPECIFICATION

光源Light source:	著名品牌LED光源/famous brand LED light source
常规功率Conventional power:	20W/30W/50W/60W/100W/120W/150W
工作电压/Voltage:	AC85-265V
灯具寿命/Lamp life:	>30000H
LED光色/LED color:	W/WW
色彩效果/Colour effect:	单色/Monochrome
防护等级/Protection grade:	IP65
环境温度/Environment temperature:	-30°C~+50°C
发光角度/Light angle:	120°

详细参数/SPECIFICATION

光源Light source:	著名品牌LED光源/famous brand LED light source
常规功率Conventional power:	20W/30W/50W/100W/150W
工作电压/Voltage:	AC85-265V
灯具寿命/Lamp life:	>30000H
LED光色/LED color:	W/WW
色彩效果/Colour effect:	单色/Monochrome
防护等级/Protection grade:	IP65
环境温度/Environment temperature:	-30°C~+50°C
发光角度/Light angle:	120°

详细参数/SPECIFICATION

光源Light source:	著名品牌LED光源/famous brand LED light source
常规功率Conventional power:	40W/60W/96W/150W/200W
工作电压/Voltage:	AC85-265V
灯具寿命/Lamp life:	>30000H
LED光色/LED color:	W/WW
色彩效果/Colour effect:	单色/Monochrome
防护等级/Protection grade:	IP65
环境温度/Environment temperature:	-30°C~+50°C
发光角度/Light angle:	120°

LED STREET LAMP SERIES
LED路灯系列



LD-020



100W L410xW300xH80mm
150W L490xW300xH80mm
200W L570xW300xH80mm
250W L650xW300xH80mm

详细参数/SPECIFICATION

光源Light source:	著名品牌LED光源/famous brand LED light source
常规功率Conventional power:	100W/150W/200W/250W/300W
工作电压/Voltage:	AC85-265V
灯具寿命/Lamp life:	≥30000H
LED光色/LED color:	W/WW
色彩效果/Colour effect:	单色/Monochrome
防护等级/Protection grade:	IP65
环境温度/Environment temperature:	-30℃~+50℃
发光角度/Light angle:	120°



LD-021



50W L480xW285xH93mm
100W L610xW285xH93mm
150W L740xW285xH93mm
200W L870xW285xH93mm

详细参数/SPECIFICATION

光源Light source:	著名品牌LED光源/famous brand LED light source
常规功率Conventional power:	50W/100W/150W/200W
工作电压/Voltage:	AC85-265V
灯具寿命/Lamp life:	≥30000H
LED光色/LED color:	W/WW
色彩效果/Colour effect:	单色/Monochrome
防护等级/Protection grade:	IP65
环境温度/Environment temperature:	-30℃~+50℃
发光角度/Light angle:	120°



LD-022



60W L470xW350mm
90W L560xW350mm
120W L650xW350mm
150W L740xW350mm

详细参数/SPECIFICATION

光源Light source:	著名品牌LED光源/famous brand LED light source
常规功率Conventional power:	30W/60W/90W/120W/150W
工作电压/Voltage:	AC85-265V
灯具寿命/Lamp life:	≥30000H
LED光色/LED color:	W/WW
色彩效果/Colour effect:	单色/Monochrome
防护等级/Protection grade:	IP65
环境温度/Environment temperature:	-30℃~+50℃
发光角度/Light angle:	30° /60° /90° /120°



LED STREET LAMP SERIES
LED路灯系列



LD-023



60W L560xW310mm
90W L650xW310mm
120W L740xW310mm
150W L830xW310mm

详细参数/SPECIFICATION

光源Light source:	著名品牌LED光源/famous brand LED light source
常规功率Conventional power:	60W/90W/120W/150W
工作电压/Voltage:	AC85-265V
灯具寿命/Lamp life:	≥30000H
LED光色/LED color:	W/WW
色彩效果/Colour effect:	单色/Monochrome
防护等级/Protection grade:	IP65
环境温度/Environment temperature:	-30℃~+50℃
发光角度/Light angle:	30° /60° /90° /120°

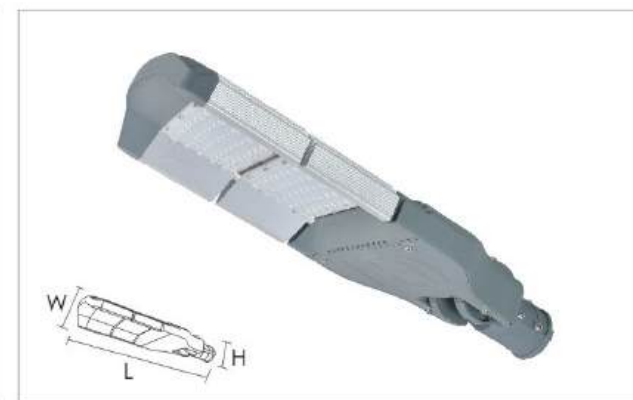

LD-024



80W L665xW310xH90mm
120W L790xW310xH90mm
160W L915xW310xH90mm

详细参数/SPECIFICATION

光源Light source:	著名品牌LED光源/famous brand LED light source
常规功率Conventional power:	80W/120W/160W/200W
工作电压/Voltage:	AC85-265V
灯具寿命/Lamp life:	≥30000H
LED光色/LED color:	W/WW
色彩效果/Colour effect:	单色/Monochrome
防护等级/Protection grade:	IP65
环境温度/Environment temperature:	-30℃~+50℃
发光角度/Light angle:	30° /60° /90° /120°

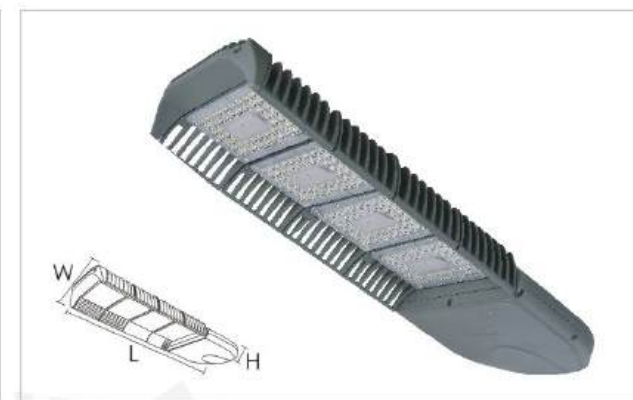

LD-025



160W L600xW340xH100mm
240W L735xW340xH100mm
320W L870xW340xH100mm
400W L1005xW340xH100mm
480W L1140xW340xH100mm

详细参数/SPECIFICATION

光源Light source:	著名品牌LED光源/famous brand LED light source
常规功率Conventional power:	160W/240W/320W/400W/480W
工作电压/Voltage:	AC85-265V
灯具寿命/Lamp life:	≥30000H
LED光色/LED color:	W/WW
色彩效果/Colour effect:	单色/Monochrome
防护等级/Protection grade:	IP65
环境温度/Environment temperature:	-30℃~+50℃
发光角度/Light angle:	30° /60° /90° /120°

LED STREET LAMP SERIES
LED路灯系列



LD-026



详细参数/SPECIFICATION	
光源Light source:	著名品牌LED光源/famous brand LED light source
常规功率Conventional power:	50W/75W/100W/125W/150W/175W
工作电压/Voltage:	AC85-265V
灯具寿命/Lamp life:	>30000H
LED光色/LED color:	W/WW
色彩效果/Colour effect:	单色/Monochrome
防护等级/Protection grade:	IP65
环境温度/Environment temperature:	-30°C~+50°C
发光角度/Light angle:	30° /60° /90° /120°



LD-027



详细参数/SPECIFICATION	
光源Light source:	著名品牌LED光源/famous brand LED light source
常规功率Conventional power:	24W/30W/40W/50W/60W/80W/90W/100W
工作电压/Voltage:	AC85-265V
灯具寿命/Lamp life:	>30000H
LED光色/LED color:	W/WW
色彩效果/Colour effect:	单色/Monochrome
防护等级/Protection grade:	IP65
环境温度/Environment temperature:	-30°C~+50°C
发光角度/Light angle:	30° /60° /90° /120°



LD-028



详细参数/SPECIFICATION	
光源Light source:	著名品牌LED光源/famous brand LED light source
常规功率Conventional power:	48W/72W/96W/120W/144W
工作电压/Voltage:	AC85-265V
灯具寿命/Lamp life:	>30000H
LED光色/LED color:	W/WW
色彩效果/Colour effect:	单色/Monochrome
防护等级/Protection grade:	IP65
环境温度/Environment temperature:	-30°C~+50°C
发光角度/Light angle:	30° /60° /90° /120°



LED STREET LAMP SERIES
LED路灯系列



LD-029

详细参数/SPECIFICATION	
光源Light source:	著名品牌LED光源
常规功率Conventional power:	150W
工作电压/Voltage:	AC85-265V
灯具寿命/Lamp life:	>30000H
LED光色/LED color:	W/WW
色彩效果/Colour effect:	单色/Monochrome
防护等级/Protection grade:	IP65
环境温度/Environment temperature:	-30°C~+50°C
灯具材质/Lamp material:	铝材/AL

线条尺寸图/Line size chart

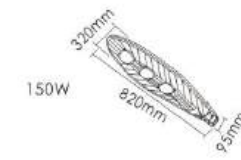

LD-030

详细参数/SPECIFICATION	
光源Light source:	著名品牌LED光源
常规功率Conventional power:	200W
工作电压/Voltage:	AC85-265V
灯具寿命/Lamp life:	>30000H
LED光色/LED color:	W/WW
色彩效果/Colour effect:	单色/Monochrome
防护等级/Protection grade:	IP65
环境温度/Environment temperature:	-30°C~+50°C
灯具材质/Lamp material:	铝材/AL

线条尺寸图/Line size chart



LD-031

详细参数/SPECIFICATION	
光源Light source:	著名品牌LED光源
常规功率Conventional power:	120W
工作电压/Voltage:	AC85-265V
灯具寿命/Lamp life:	>30000H
LED光色/LED color:	W/WW
色彩效果/Colour effect:	单色/Monochrome
防护等级/Protection grade:	IP65
环境温度/Environment temperature:	-30°C~+50°C
灯具材质/Lamp material:	铝材+钢化玻璃/AL+TG

线条尺寸图/Line size chart

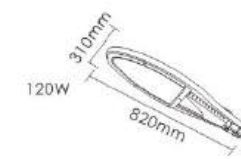

LD-032

详细参数/SPECIFICATION	
光源Light source:	著名品牌LED光源
常规功率Conventional power:	50W
工作电压/Voltage:	AC85-265V
灯具寿命/Lamp life:	>30000H
LED光色/LED color:	W/WW
色彩效果/Colour effect:	单色/Monochrome
防护等级/Protection grade:	IP65
环境温度/Environment temperature:	-30°C~+50°C
灯具材质/Lamp material:	铝材/AL

线条尺寸图/Line size chart



LED STREET LAMP SERIES
LED路灯系列



LD-033

详细参数/SPECIFICATION

光源Light source:
著名品牌LED光源
常规功率Conventional power:
150W
工作电压/Voltage:
AC85-265V
灯具寿命/Lamp life:
>30000H
LED光色/LED color:
W/WW
色彩效果/Colour effect:
单色/Monochrome
防护等级/Protection grade:
IP65
环境温度/Environment temperature:
-30℃~+50℃
灯具材质/Lamp material:
铝材/AL

线条尺寸图/Line size chart

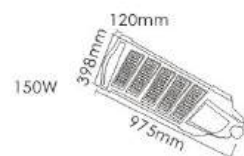

LD-034

详细参数/SPECIFICATION

光源Light source:
著名品牌LED光源
常规功率Conventional power:
112W
工作电压/Voltage:
AC85-265V
灯具寿命/Lamp life:
>30000H
LED光色/LED color:
W/WW
色彩效果/Colour effect:
单色/Monochrome
防护等级/Protection grade:
IP65
环境温度/Environment temperature:
-30℃~+50℃
灯具材质/Lamp material:
铝材/AL

线条尺寸图/Line size chart

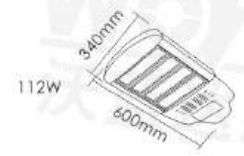

LD-035

详细参数/SPECIFICATION

光源Light source:
著名品牌LED光源
常规功率Conventional power:
120W
工作电压/Voltage:
AC85-265V
灯具寿命/Lamp life:
>30000H
LED光色/LED color:
W/WW
色彩效果/Colour effect:
单色/Monochrome
防护等级/Protection grade:
IP65
环境温度/Environment temperature:
-30℃~+50℃
灯具材质/Lamp material:
铝材/AL

线条尺寸图/Line size chart

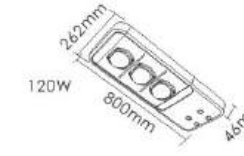

LD-036

详细参数/SPECIFICATION

光源Light source:
著名品牌LED光源
常规功率Conventional power:
120W
工作电压/Voltage:
AC85-265V
灯具寿命/Lamp life:
>30000H
LED光色/LED color:
W/WW
色彩效果/Colour effect:
单色/Monochrome
防护等级/Protection grade:
IP65
环境温度/Environment temperature:
-30℃~+50℃
灯具材质/Lamp material:
铝材/AL

线条尺寸图/Line size chart

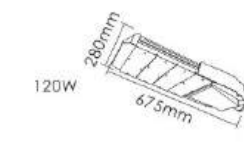

LED STREET LAMP SERIES
LED路灯系列



LD-037

详细参数/SPECIFICATION

光源Light source:
著名品牌LED光源
常规功率Conventional power:
96W
工作电压/Voltage:
AC85-265V
灯具寿命/Lamp life:
>30000H
LED光色/LED color:
W/WW
色彩效果/Colour effect:
单色/Monochrome
防护等级/Protection grade:
IP65
环境温度/Environment temperature:
-30℃~+50℃
灯具材质/Lamp material:
铝材/AL

线条尺寸图/Line size chart

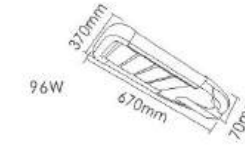

LD-038

详细参数/SPECIFICATION

光源Light source:
著名品牌LED光源
常规功率Conventional power:
80W
工作电压/Voltage:
AC85-265V
灯具寿命/Lamp life:
>30000H
LED光色/LED color:
W/WW
色彩效果/Colour effect:
单色/Monochrome
防护等级/Protection grade:
IP65
环境温度/Environment temperature:
-30℃~+50℃
灯具材质/Lamp material:
铝材/AL

线条尺寸图/Line size chart

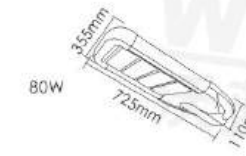

LD-039

详细参数/SPECIFICATION

光源Light source:
著名品牌LED光源
常规功率Conventional power:
30W
工作电压/Voltage:
AC85-265V
灯具寿命/Lamp life:
>30000H
LED光色/LED color:
W/WW
色彩效果/Colour effect:
单色/Monochrome
防护等级/Protection grade:
IP65
环境温度/Environment temperature:
-30℃~+50℃
灯具材质/Lamp material:
铝材+钢化玻璃/AL+TG

线条尺寸图/Line size chart

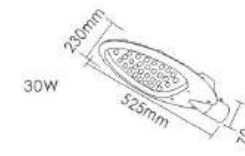

LD-040

详细参数/SPECIFICATION

光源Light source:
著名品牌LED光源
常规功率Conventional power:
3x30W
工作电压/Voltage:
AC85-265V
灯具寿命/Lamp life:
>30000H
LED光色/LED color:
W/WW
色彩效果/Colour effect:
单色/Monochrome
防护等级/Protection grade:
IP65
环境温度/Environment temperature:
-30℃~+50℃
灯具材质/Lamp material:
铝材/AL

线条尺寸图/Line size chart

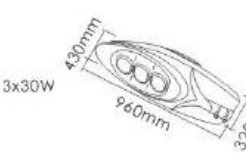



WORLD
沃蓝达照明

WORLD
沃蓝达照明

WORLD
沃蓝达照明

WORLD
沃蓝达照明



产品特点

- 灯体均采用优质铝材或不锈钢等材料，坚固耐用，防渗水，散热性能优良，灯体美观精致；
- 灯体采用高强度钢化玻璃，透光度高，光线辐射面宽，防腐蚀，抗老化；
- 采用硅胶密封，内部环氧树脂灌胶，使灯体内部电路全封闭另加抗老化密封胶圈，实现卓越的防水性能；
- 低耗高效进口光源，光通量高、显色性强，使用寿命可达5万小时；
- 灯具采用PMMA光学透镜，可选角度15° 30° 45° 60°；
- 安装：直接将灯插入喷水管，然后用螺丝固定，安装方便；
- 输入电压有AC12V和AC24V；
- 灯具控制方式：单色常亮效果（红、绿、蓝、黄、白、暖白）；内控同步RGB七彩变化，实现同步等变化效果；
- 有效投射范围：≤10米；
- 护水等级：IP68，可承受10米水柱冲击。

适用范围

广泛应用于水族馆、水池雕塑、广场喷泉、游泳池、游泳馆、公园水池、广场喷泉、人工瀑布及其他特殊环境装饰照明；

Product features

- In pieces the lamp body adopts high-quality aluminum or stainless steel materials, such as strong and durable, waterproof, good heat dissipation performance, light body beautiful and delicate;
- High strength of toughened glass lamp body, strong penetrability, light radiation noodles wide, anti-corrosion, anti-aging;
- Using silica gel seal, internal epoxy resin glue, make the circuit inside the lamp body totally enclosed sha-lu plus anti-aging sealant, achieve superior waterproof performance;
- Low energy efficient import light source, high luminous flux and color rendering, service life can reach 50000 hours.
- Lamps and lanterns of mixer adopt PMMA optical lens, optional Angle 45° to 60°, 15° to 30°
- Installation: insert the lamp directly spray nozzle, then screwed, installation is convenient;
- In pieces the input voltage AC12V and AC24V;
- Lamps and lanterns control mode: monochrome Chang Liang effect (red, green, blue, yellow, white, warm white); Internal control synchronous RGB 7 colour changes, the change such as synchronization effect;
- Effective range: 10 meters or less;
- To protect the water level: IP68, 10 m water column can withstand impact.

Scope of application

Widely used in the aquarium, sculpture, square fountain pool, swimming pool, swimming pool, pool, park square fountain, artificial waterfalls and other special environment decorative lighting;

WORLD
沃蓝达照明

WORLD
沃蓝达照明

安装使用说明 Installation Instructions for use

1. 根据现场场景布置好灯的位置，并固定好；
2. 连接好DMX512信号线和电源线，本产品配有国际标准DMX512信号线，公接为信号输入，母接为信号输出；
3. 确认安装无误、无电气短路；
4. 参照操作说明，通电把灯的地址调到控制器对应的通道；
5. 按照DMX512原理，所连接的灯具超过32个小时，要加上对应的中继器；
6. 如果在安装中出现问题，请咨询本公司技术人员。

1. Arrange the position of the lamp according to the scene and fix it;
2. Connect DMX512 signal cable and power cable. This product is equipped with international standard DMX512 signal cable. The public connection is signal input and the female connection is signal output.
3. Confirm that the installation is correct and there is no electrical short circuit;
4. Refer to the operation instructions, and energize the address of the lamp to the corresponding channel of the controller;
5. According to the principle of DMX512, the connected lamps are more than 32 hours, and the corresponding repeater should be added;
6. If there is a problem during installation, please consult our technical staff.

安装示意图 Installation diagram

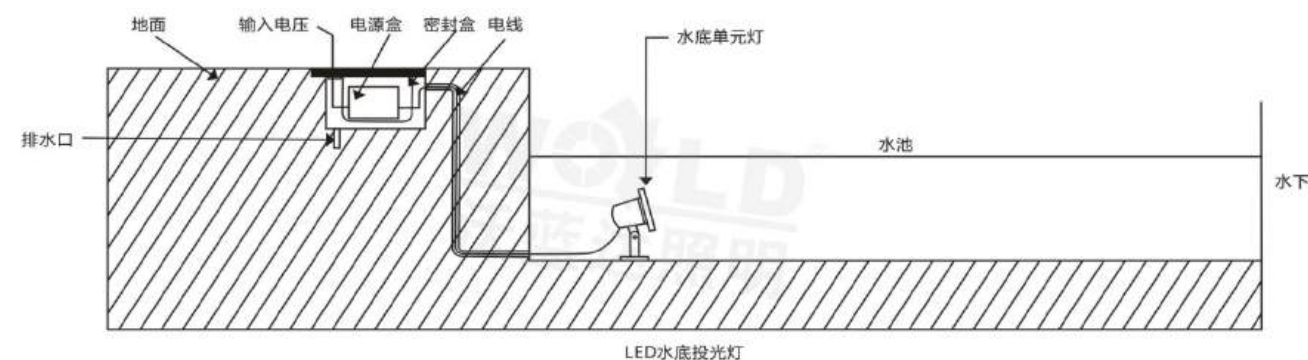
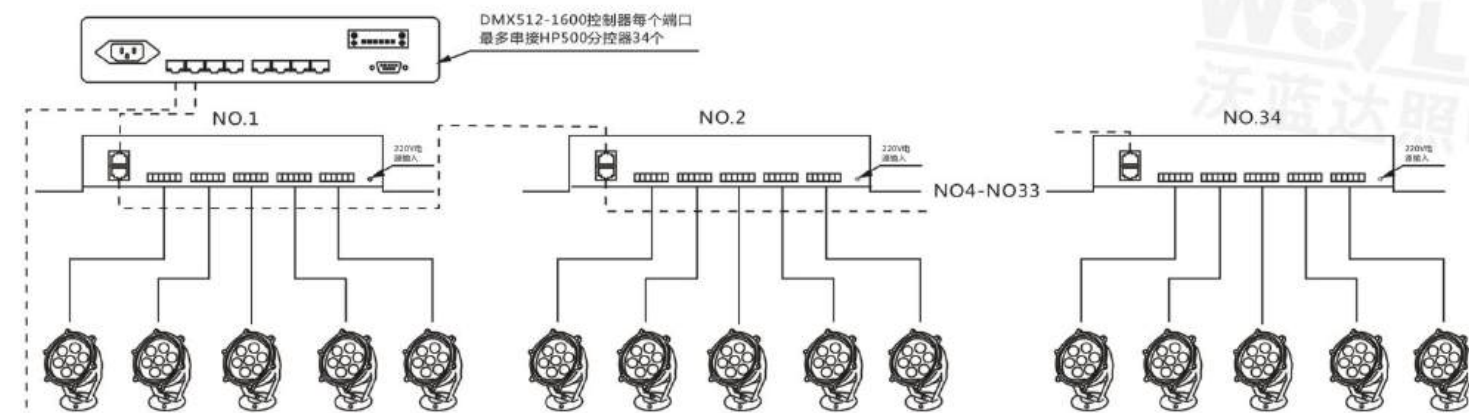

产品解析说明 Product analysis instructions

选材·解析



不锈钢灯体

采用优质不锈钢面环配以一体化防爆钢化玻璃，经阳极氧化处理，使反射光线更加均匀



高强度钢化玻璃

采用光学原理设计，经过特殊处理无光斑无花点，透光率接近100%，具有防爆、防踩压、防水、耐磨等性能



高亮LED芯片

采用高亮芯片，亮度高、低功耗、超高流明，在各种气候条件下仍能长时间稳定工作，寿命更长



光学透镜

采用PMMA光学透镜，防水防尘效果佳，灌胶封装工艺，安全使用，超长寿命，发光更均匀，透光率高达95%以上



可调固定支架

采用不锈钢材质，高强度不易滑，不易腐蚀生锈，防损坏，坚固经久耐用330°转动



防水出线口

具备防尘防水防腐、绝缘抗冲击等特性，不锈钢出口螺帽，增加防水胶圈垫片，IP68防水级别，使用更安全



不锈钢螺丝

采用不锈钢材质，高强度不易滑，不易腐蚀生锈，防损坏，不易脱落，加强支架部分的稳定性



国标全铜线

国标三芯全铜线材，导电强，功率高，线材柔软，不易折断，专业稳流，耐候性强，防雷击。

LED UNDERWATER LAMP SERIES
LED水底灯系列



SDD-001

详细参数/SPECIFICATION

光源/Light source:	著名品牌LED光源/famous brand LED light source
常规功率/Conventional power:	3W/3x3W
灯具尺寸/Lamp size:	Ø80xL55xH100mm
工作电压/Voltage:	DC12-24V
灯具寿命/Lamp life:	≥30000H
LED光色/LED color:	R/Y/B/G/W/WW/RGB
色彩效果/Colour effect:	全彩、单色/full colour, monochrome
控制方式/Control mode:	国际标准DMX512/International standard DMX512
防护等级/Protection grade:	IP68
环境温度/Environment temperature:	-30℃~+50℃
发光角度/Light angle:	15° /30° /45° /60° /90° /120°

线条尺寸图/Line size chart

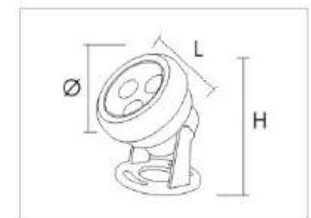

产品细节图/Product detail map



配光曲线图/Light distribution curve

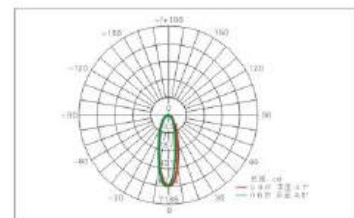

应用场景/Application scenario

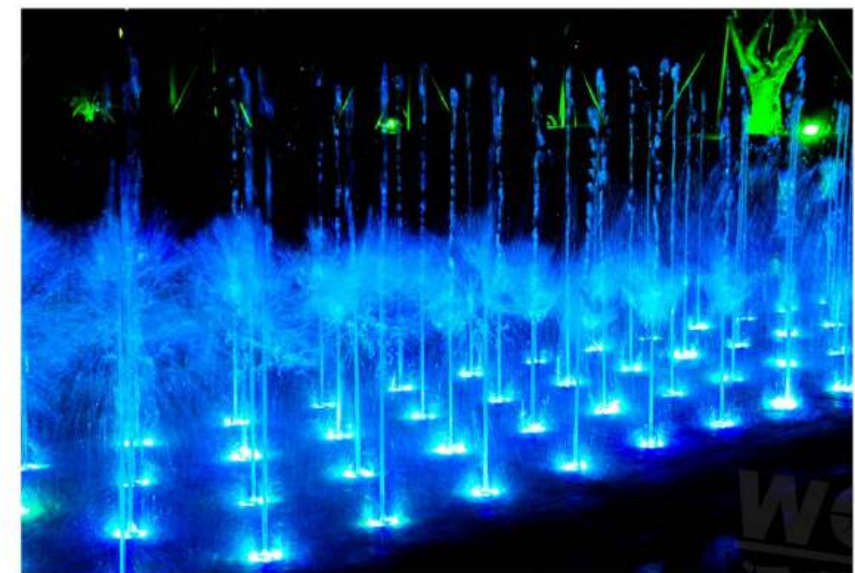

表面处理: 表面经阳极氧化、户外等级喷涂处理
Surface treatment: The surface is sprayed by anodic oxidation and outdoor grade

灯具材质: 采用优质航空铝材或不锈钢, 钢化玻璃面盖
Lamp material: Use high quality aviation aluminum or stainless steel, steel glass face cover

应用场所: 水族馆、公园水池雕塑、广场喷泉、游泳池、游泳馆、人工瀑布
Application places: Aquarium, park pool sculpture, square fountain, swimming pool, swimming pool, artificial waterfall

LED UNDERWATER LAMP SERIES
LED水底灯系列



SDD-002

详细参数/SPECIFICATION

光源/Light source:	著名品牌LED光源/famous brand LED light source
常规功率/Conventional power:	9W
灯具尺寸/Lamp size:	Ø136xL70xH170mm
工作电压/Voltage:	DC12-24V
灯具寿命/Lamp life:	≥30000H
LED光色/LED color:	R/Y/B/G/W/WW/RGB
色彩效果/Colour effect:	全彩、单色/full colour, monochrome
控制方式/Control mode:	国际标准DMX512/International standard DMX512
防护等级/Protection grade:	IP68
环境温度/Environment temperature:	-30℃~+50℃
发光角度/Light angle:	15° /30° /45° /60° /90° /120°

线条尺寸图/Line size chart

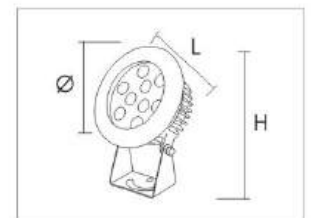

产品细节图/Product detail map



配光曲线图/Light distribution curve

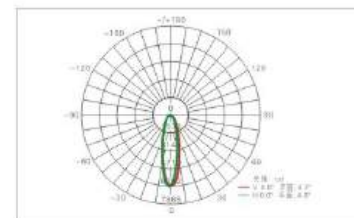

应用场景/Application scenario

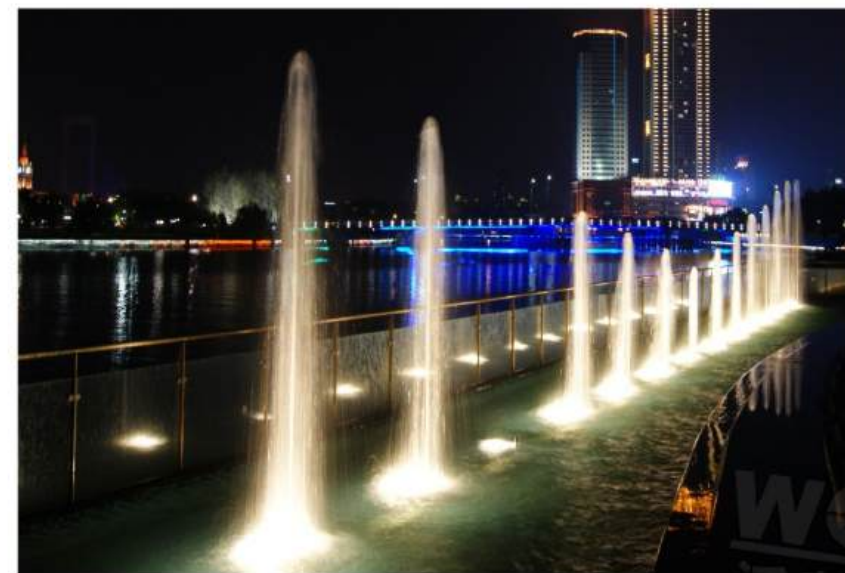

表面处理: 表面经阳极氧化、户外等级喷涂处理
Surface treatment: The surface is sprayed by anodic oxidation and outdoor grade

灯具材质: 采用优质航空铝材或不锈钢, 钢化玻璃面盖
Lamp material: Use high quality aviation aluminum or stainless steel, steel glass face cover

应用场所: 水族馆、公园水池雕塑、广场喷泉、游泳池、游泳馆、人工瀑布
Application places: Aquarium, park pool sculpture, square fountain, swimming pool, swimming pool, artificial waterfall



SDD-003

详细参数/SPECIFICATION

光源/Light source:	著名品牌LED光源/famous brand LED light source
常规功率/Conventional power:	9W
灯具尺寸/Lamp size:	Ø125xL65xH170mm
工作电压/Voltage:	DC12-24V
灯具寿命/Lamp life:	≥30000H
LED光色/LED color:	R/Y/B/G/W/WW/RGB
色彩效果/Colour effect:	全彩、单色/full colour, monochrome
控制方式/Control mode:	国际标准DMX512/International standard DMX512
防护等级/Protection grade:	IP68
环境温度/Environment temperature:	-30℃~+50℃
发光角度/Light angle:	15° /30° /45° /60° /90° /120°

线条尺寸图/Line size chart

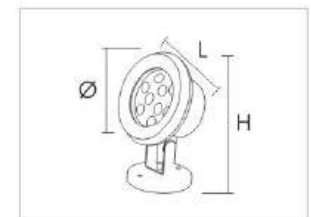

产品细节图/Product detail map



配光曲线图/Light distribution curve

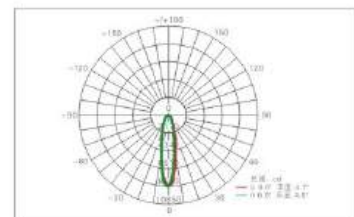

应用场景/Application scenario



表面处理: 表面经阳极氧化、户外等级喷涂处理
Surface treatment: The surface is sprayed by anodic oxidation and outdoor grade

灯具材质: 采用优质航空铝材或不锈钢, 钢化玻璃面盖
Lamp material: Use high quality aviation aluminum or stainless steel, steel glass face cover

应用场所: 水族馆、公园水池雕塑、广场喷泉、游泳池、游泳馆、人工瀑布
Application places: Aquarium, park pool sculpture, square fountain, swimming pool, swimming pool, artificial waterfall



SDD-004

详细参数/SPECIFICATION

光源/Light source:	著名品牌LED光源/famous brand LED light source
常规功率/Conventional power:	6W/9W/12W/18W
工作电压/Voltage:	DC12-24V
灯具寿命/Lamp life:	≥30000H
LED光色/LED color:	R/Y/B/G/W/WW/RGB
色彩效果/Colour effect:	全彩、单色/full colour, monochrome
控制方式/Control mode:	国际标准DMX512/International standard DMX512
防护等级/Protection grade:	IP68
环境温度/Environment temperature:	-30℃~+50℃
发光角度/Light angle:	15° /30° /45° /60° /90° /120°

线条尺寸图/Line size chart

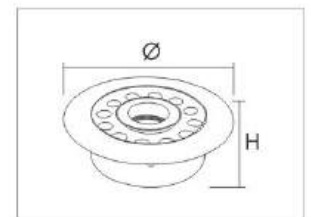

产品细节图/Product detail map



配光曲线图/Light distribution curve

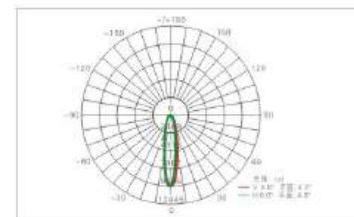

应用场景/Application scenario



6W
Ø130xH70mm

9-12W
Ø160xH70mm

18W
Ø180xH80mm

应用场所: 水族馆、公园水池雕塑、广场喷泉、游泳池、游泳馆、人工瀑布
Application places: Aquarium, park pool sculpture, square fountain, swimming pool, swimming pool, artificial waterfall



SDD-005

详细参数/SPECIFICATION

光源/Light source:	著名品牌LED光源/famous brand LED light source
常规功率/Conventional power:	1W/3W/5W/6W/7W/9W/12W/15W/18W/24W
工作电压/Voltage:	DC12-24V
灯具寿命/Lamp life:	≥30000H
LED光色/LED color:	R/Y/B/G/W/WW/RGB
色彩效果/Colour effect:	全彩、单色/full colour, monochrome
控制方式/Control mode:	国际标准DMX512/International standard DMX512
防护等级/Protection grade:	IP68
环境温度/Environment temperature:	-30℃~+50℃
发光角度/Light angle:	15° /30° /45° /60° /90° /120°

线条尺寸图/Line size chart 产品细节图/Product detail map 配光曲线图/Light distribution curve 应用场景/Application scenario

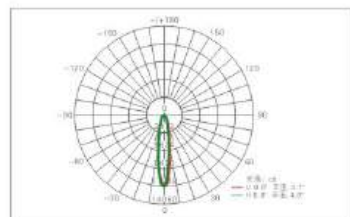
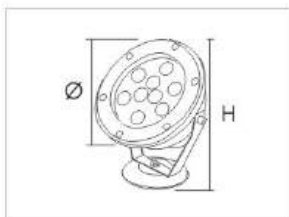

应用场所: 水族馆、公园水池雕塑、广场喷泉、游泳池、游泳馆、人工瀑布
Application places: Aquarium, park pool sculpture, square fountain, swimming pool, swimming pool, artificial waterfall



SDD-006

详细参数/SPECIFICATION

光源/Light source:	著名品牌LED光源/famous brand LED light source
常规功率/Conventional power:	6W/7W/9W/12W/18W
工作电压/Voltage:	DC12-24V
灯具寿命/Lamp life:	≥30000H
LED光色/LED color:	R/Y/B/G/W/WW/RGB
色彩效果/Colour effect:	全彩、单色/full colour, monochrome
控制方式/Control mode:	国际标准DMX512/International standard DMX512
防护等级/Protection grade:	IP68
环境温度/Environment temperature:	-30℃~+50℃
发光角度/Light angle:	15° /30° /45° /60° /90° /120°

线条尺寸图/Line size chart 产品细节图/Product detail map 配光曲线图/Light distribution curve 应用场景/Application scenario

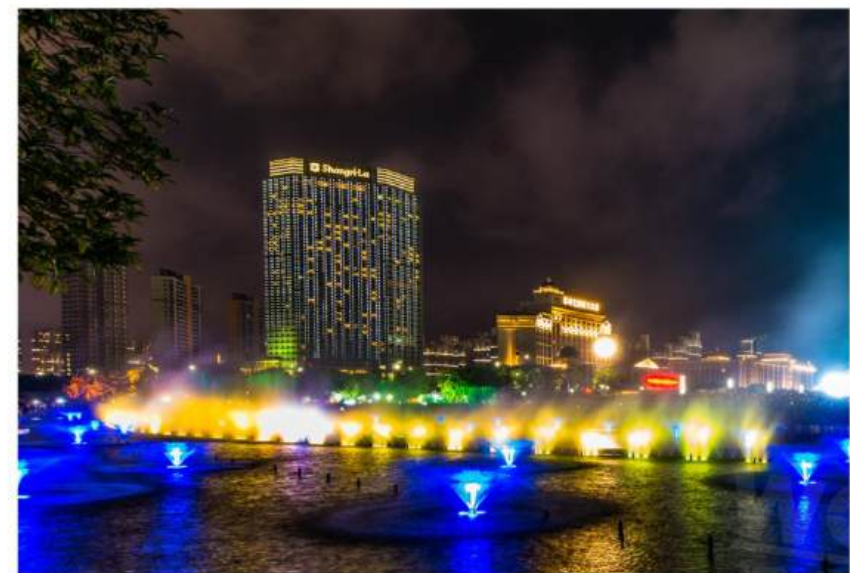
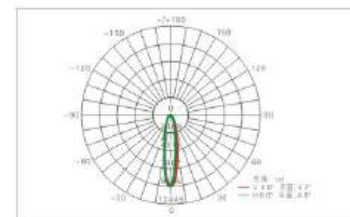
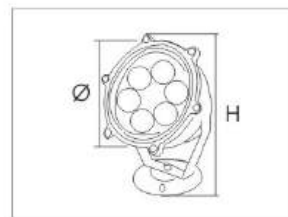

应用场所: 水族馆、公园水池雕塑、广场喷泉、游泳池、游泳馆、人工瀑布
Application places: Aquarium, park pool sculpture, square fountain, swimming pool, swimming pool, artificial waterfall

LED UNDERWATER LAMP SERIES
LED水底灯系列



SDD-007

详细参数/SPECIFICATION

光源/Light source:	著名品牌LED光源/famous brand LED light source
常规功率/Conventional power:	3W/6W/9W/18W/24W
工作电压/Voltage:	DC12-24V
灯具寿命/Lamp life:	>30000H
LED光色/LED color:	R/Y/B/G/W/WW/RGB
色彩效果/Colour effect:	全彩、单色/full colour, monochrome
控制方式/Control mode:	国际标准DMX512/International standard DMX512
防护等级/Protection grade:	IP68
环境温度/Environment temperature:	-30℃~+50℃
发光角度/Light angle:	15° /30° /45° /60° /90° /120°

线条尺寸图/Line size chart

产品细节图/Product detail map

配光曲线图/Light distribution curve

应用场景/Application scenario

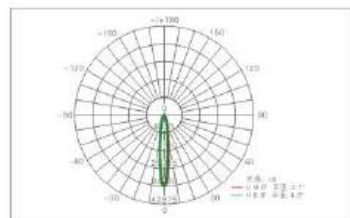
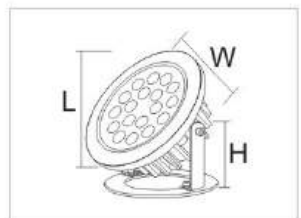

应用场所: 水族馆、公园水池雕塑、广场喷泉、游泳池、游泳馆、人工瀑布
Application places: Aquarium, park poolsculpture, square fountain, swimming pool, swimming pool, artificial waterfall

LED UNDERWATER LAMP SERIES
LED水底灯系列



SDD-008

详细参数/SPECIFICATION

光源/Light source:	著名品牌LED光源
常规功率/Conventional power:	3W
工作电压/Voltage:	DC12-24V
灯具寿命/Lamp life:	>30000H
LED光色/LED color:	R/Y/B/G/W/WW/RGB
色彩效果/Colour effect:	全彩、单色/full colour, monochrome
防护等级/Protection grade:	IP68
环境温度/Environment temperature:	-30℃~+50℃
灯具材质/Lamp material:	不锈钢+钢化玻璃/SS+TG

线条尺寸图/Line size chart

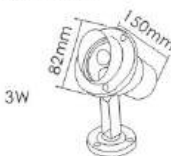

SDD-009

详细参数/SPECIFICATION

光源/Light source:	著名品牌LED光源
常规功率/Conventional power:	5W
工作电压/Voltage:	DC12-24V
灯具寿命/Lamp life:	>30000H
LED光色/LED color:	R/Y/B/G/W/WW/RGB
色彩效果/Colour effect:	全彩、单色/full colour, monochrome
防护等级/Protection grade:	IP68
环境温度/Environment temperature:	-30℃~+50℃
灯具材质/Lamp material:	不锈钢+钢化玻璃/SS+TG

线条尺寸图/Line size chart



SDD-010

详细参数/SPECIFICATION

光源/Light source:	著名品牌LED光源
常规功率/Conventional power:	12W
工作电压/Voltage:	DC12-24V
灯具寿命/Lamp life:	>30000H
LED光色/LED color:	R/Y/B/G/W/WW/RGB
色彩效果/Colour effect:	全彩、单色/full colour, monochrome
防护等级/Protection grade:	IP68
环境温度/Environment temperature:	-30℃~+50℃
灯具材质/Lamp material:	不锈钢+钢化玻璃/SS+TG

线条尺寸图/Line size chart

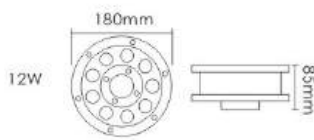

SDD-011

详细参数/SPECIFICATION

光源/Light source:	著名品牌LED光源
常规功率/Conventional power:	6W/7W/9W/12W/18W
工作电压/Voltage:	DC12-24V
灯具寿命/Lamp life:	>30000H
LED光色/LED color:	R/Y/B/G/W/WW/RGB
色彩效果/Colour effect:	全彩、单色/full colour, monochrome
防护等级/Protection grade:	IP68
环境温度/Environment temperature:	-30℃~+50℃
灯具材质/Lamp material:	铝材+钢化玻璃/AL+TG

线条尺寸图/Line size chart

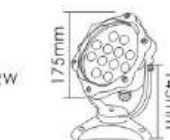



产品特点

- 灯具外壳采用高强度优质铝材及不锈钢灯盖，灯体美观精致，散热性能优良；
- 灯体采用钢化玻璃及抗老化硅胶密封，内部环氧树脂灌胶，使灯体内部电路全封闭，实现双重防水，确保灯具优越的防水性能；
- 低耗高效进口光源，光通量高、显色性强，使用寿命可达到50,000时；
- 优质的防水接头，经过精密的工艺制做而成，具有优良的防水、防尘、防漏电、抗腐蚀等性能。
- 灯具采用PMMA光学级透镜，可选角度15° 25° 30° 45° 60° 120°；
- 内置恒流AC85V-AC265V宽电压驱动，确保灯具在不同国家、区域或电压不稳时可正常工作，另有低压AC24V驱动可供选择；
- 控制方式：单色常亮效果（红、绿、蓝、黄、白、暖白）；内控同步RGB七彩变化。

适用范围

广泛应用于商场、广场、街道、公园、娱乐场所、园林道路、步行街、停车场等地面装饰照明。

Product features

- Mixer shell of lamps and lanterns USES high strength high quality aluminum and stainless steel lamp cap, lamp body beautiful and delicate, excellent heat dissipation performance;
- In pieces the lamp body USES toughened glass and anti-aging silicone seal, internal epoxy resin glue, make the circuit inside the lamp body fully enclosed, realize the double waterproof, ensure superior waterproof performance of lamps and lanterns;
- Low energy efficient import light source, high luminous flux and color rendering, service life can reach 50000;
- High quality waterproof connector, through sophisticated skills, excellent waterproof, dustproof, prevent leakage and corrosion resistant performance.
- Lamps and lanterns of mixer adopt PMMA optical lens, optional Angle is 15° 25° to 30° 45° to 60° , 120°;
- Built-in constant-current AC85V pieces - AC265V wide voltage drive, ensure lamps and lanterns in different countries, regions or voltage instability can work normally, when another selection of low voltage AC24V drive;
- Control mode: monochrome Chang Liang effect (red, green, blue, yellow, white, warm white); internal control synchronous RGB 7 colour change.

Scope of application

Widely used in shopping malls, squares, streets, parks, entertainment venues, garden road, pedestrian street, parking lot etc. Ground decorative lighting.

安装使用说明 Installation Instructions for use

- 1、根据现场场景布置好灯的位置，并固定好；
- 2、连接好DMX512信号线和电源线，本产品配有国际标准DMX512信号线，公接为信号输入，母接为信号输出；
- 3、确认安装无误、无电气短路；
- 4、参照操作说明，通电把灯的地址调到控制器对应的通道；
- 5、按照DMX512原理，所连接的灯具超过32个小时，要加上对应的中继器；
- 6、如果在安装中出现问题，请咨询本公司技术人员。

1. Arrange the position of the lamp according to the scene and fix it;
2. Connect DMX512 signal cable and power cable. This product is equipped with international standard DMX512 signal cable. The public connection is signal input and the female connection is signal output.
3. Confirm that the installation is correct and there is no electrical short circuit;
4. Refer to the operation instructions, and energize the address of the lamp to the corresponding channel of the controller;
5. According to the principle of DMX512, the connected lamps are more than 32 hours, and the corresponding repeater should be added;
6. If there is a problem during installation, please consult our technical staff.

安装示意图 Installation diagram

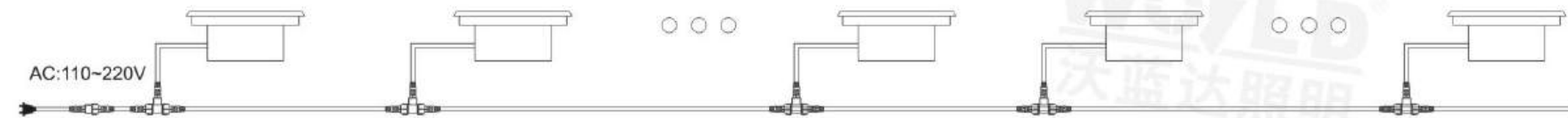

说明：每个回路上220V导线上可并接20台，并确保金属外壳连接地线。
Note: each loop 220V wire can connect 20 stations, and to ensure that the metal shell is connected with the ground wire.

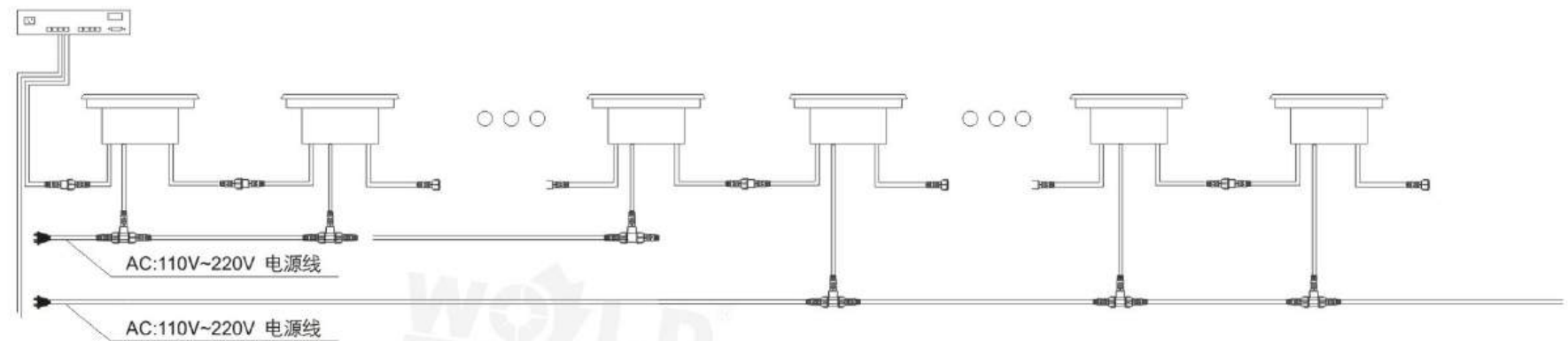

说明：DMX512-1600，每一个输出端口可接170台高功率埋地灯，每个回路上220V导线上可并接20台，并确保金属外壳连接地线。
Note: DMX512-1600, every output port can be connected with a 170 high power wash wall lamp, each loop 220V wire can connect 20 stations, and to ensure that the metal shell is connected with the ground wire.

产品解析说明 Product analysis instructions

选材·解析

不锈钢面环
采用优质不锈钢面环，抗压抗裂能力强，不生锈、不腐蚀、不退色，防水性能好。

高强度钢化玻璃
采用光学原理设计，经过特殊处理无光斑无花点，透光率接近100%，具有防爆、防踩压、防水、耐磨保护芯片等性能。

不锈钢螺丝
采用不锈钢材质，高强度不易滑，不易腐蚀生锈，防损坏，加强面盖部位防水性能。

高亮LED芯片
采用高亮芯片，亮度高、低功耗、高流明，在各种气候条件下仍能长时间稳定工作，寿命更长。

光学透镜
采用PMMA光学透镜，防水防尘，灌胶封装工艺，能很好地保护芯片，安全使用，寿命长，发光更均匀，透光率高达95%以上。

防水出线口
具备防尘防水防腐、绝缘抗冲击等特性，不锈钢出口螺帽，增加防水胶圈垫片，IP65防水级别，使用更安全。

PC预埋件
采用ABS阻燃材料，预埋地安装，为后期埋灯嵌入安装提供便利，起到埋灯灯体不受侵蚀作用。

国标全铜线
国标三芯全铜线材，导电强，功率高，线材柔软，不易折断，专业稳流，耐候性强，防雷击。



MDD-AD01

详细参数/SPECIFICATION

光源/Light source:	著名品牌LED光源/famous brand LED light source
常规功率/Conventional power:	12W/24W/36W
工作电压/Voltage:	DC24V/AC220V
灯具寿命/Lamp life:	≥30000H
LED光色/LED color:	R/Y/B/G/W/WW/RGB
色彩效果/Colour effect:	全彩、单色/full colour, monochrome
控制方式/Control mode:	国际标准DMX512/International standard DMX512
防护等级/Protection grade:	IP65
环境温度/Environment temperature:	-30℃~+50℃
发光角度/Light angle:	15° /30° /45° /60° /90° /120°

线条尺寸图/Line size chart



产品细节图/Product detail map



配光曲线图/Light distribution curve

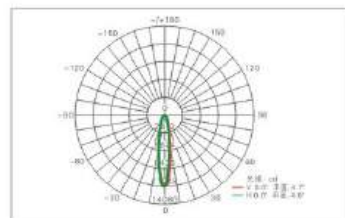

应用场景/Application scenario



应用场所: 商场、广场、街道、公园、娱乐场所、园林道路、步行街、停车场等地面装饰照明
Application places: Shopping malls, squares, streets, parks, entertainment venues, garden roads, pedestrian streets, parking lots and other ground decoration lighting



MDD-MG02

详细参数/SPECIFICATION

光源/Light source:	著名品牌LED光源/famous brand LED light source
常规功率/Conventional power:	3W/6W/7W/9W/12W/15W/18W/24W/36W
工作电压/Voltage:	DC24V/AC220V
灯具寿命/Lamp life:	≥30000H
LED光色/LED color:	R/Y/B/G/W/WW/RGB
色彩效果/Colour effect:	全彩、单色/full colour, monochrome
控制方式/Control mode:	国际标准DMX512/International standard DMX512
防护等级/Protection grade:	IP65
环境温度/Environment temperature:	-30℃~+50℃
发光角度/Light angle:	15° /30° /45° /60° /90° /120°

线条尺寸图/Line size chart

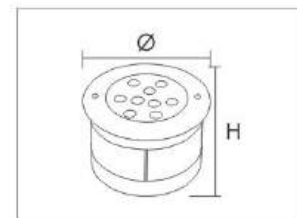

产品细节图/Product detail map



配光曲线图/Light distribution curve

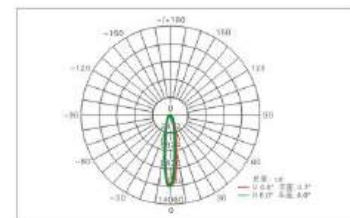

应用场景/Application scenario

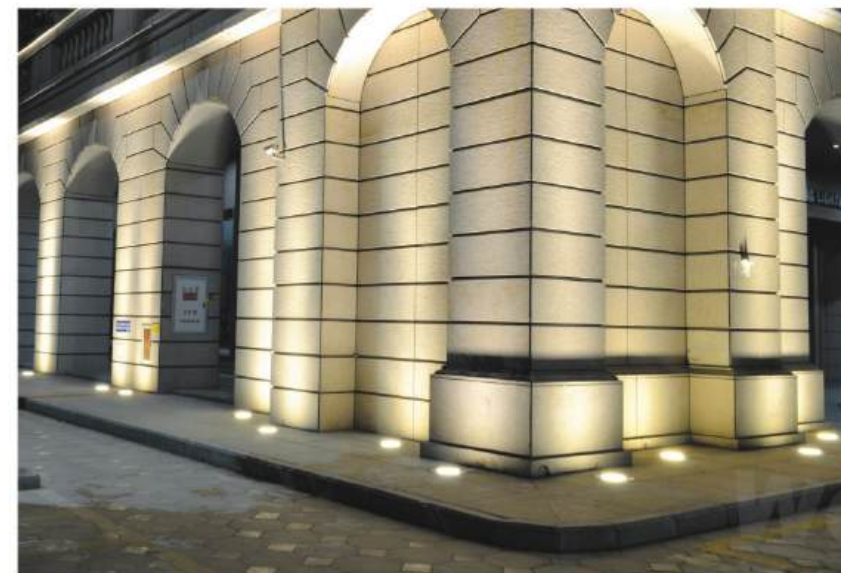

应用场所: 商场、广场、街道、公园、娱乐场所、园林道路、步行街、停车场等地面装饰照明
Application places: Shopping malls, squares, streets, parks, entertainment venues, garden roads, pedestrian streets, parking lots and other ground decoration lighting



MDD-MG03

详细参数/SPECIFICATION

光源/Light source:	著名品牌LED光源/famous brand LED light source
常规功率/Conventional power:	1W/3W/5W/6W/9W/12W/18W/24W/36W
工作电压/Voltage:	DC24V/AC220V
灯具寿命/Lamp life:	≥30000H
LED光色/LED color:	R/Y/B/G/W/WW/RGB
色彩效果/Colour effect:	全彩、单色/full colour, monochrome
控制方式/Control mode:	国际标准DMX512/International standard DMX512
防护等级/Protection grade:	IP65
环境温度/Environment temperature:	-30℃~+50℃
发光角度/Light angle:	左右调节5°

线条尺寸图/Line size chart



产品细节图/Product detail map



配光曲线图/Light distribution curve

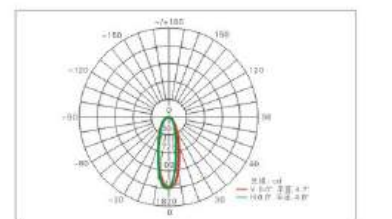

应用场景/Application scenario



应用场所: 商场、广场、街道、公园、娱乐场所、园林道路、步行街、停车场等地面装饰照明
Application places: Shopping malls, squares, streets, parks, entertainment venues, garden roads, pedestrian streets, parking lots and other ground decoration lighting



MDD-004

详细参数/SPECIFICATION

光源/Light source:	著名品牌LED光源/famous brand LED light source
常规功率/Conventional power:	3W/5W/6W/9W/18W/24W/36W
工作电压/Voltage:	DC24V/AC220V
灯具寿命/Lamp life:	≥30000H
LED光色/LED color:	R/Y/B/G/W/WW/RGB
色彩效果/Colour effect:	全彩、单色/full colour, monochrome
控制方式/Control mode:	国际标准DMX512/International standard DMX512
防护等级/Protection grade:	IP65
环境温度/Environment temperature:	-30℃~+50℃
发光角度/Light angle:	30° /60° /90°



线条尺寸图/Line size chart

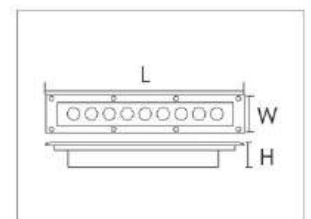

产品细节图/Product detail map



配光曲线图/Light distribution curve

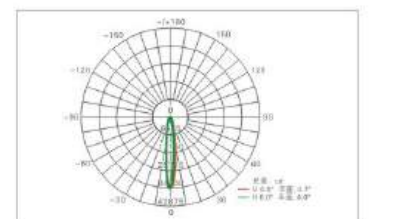

应用场景/Application scenario



应用场所: 商场、广场、街道、公园、娱乐场所、园林道路、步行街、停车场等地面装饰照明
Application places: Shopping malls, squares, streets, parks, entertainment venues, garden roads, pedestrian streets, parking lots and other ground decoration lighting



MDD-005

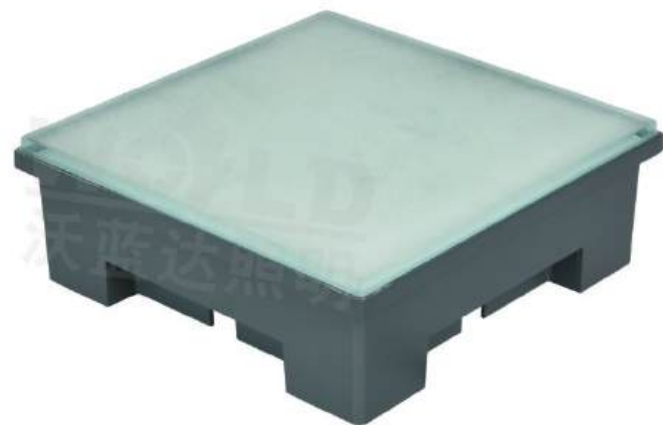

详细参数/SPECIFICATION

光源/Light source:	著名品牌LED光源/famous brand LED light source
常规功率/Conventional power:	5W/15W/30W
工作电压/Voltage:	DC24V/AC220V
灯具寿命/Lamp life:	≥30000H
LED光色/LED color:	R/Y/B/G/W/WW/RGB
色彩效果/Colour effect:	全彩、单色/full colour, monochrome
控制方式/Control mode:	国际标准DMX512/International standard DMX512
防护等级/Protection grade:	IP65
环境温度/Environment temperature:	-30℃~+50℃
发光角度/Light angle:	120°

线条尺寸图/Line size chart

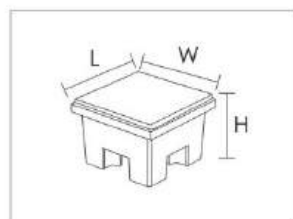

产品细节图/Product detail map



配光曲线图/Light distribution curve

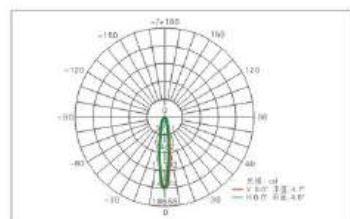

应用场景/Application scenario

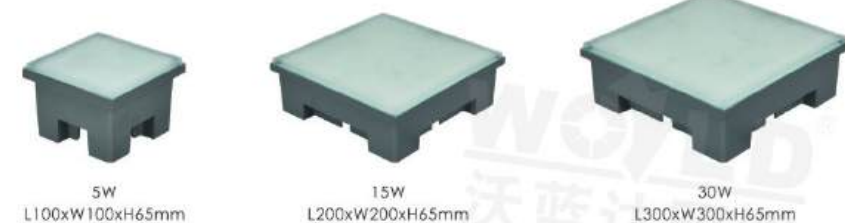

应用场所: 商场、广场、街道、公园、娱乐场所、园林道路、步行街、停车场等地面装饰照明
Application places: Shopping malls, squares, streets, parks, entertainment venues, garden roads, pedestrian streets, parking lots and other ground decoration lighting



MDD-006

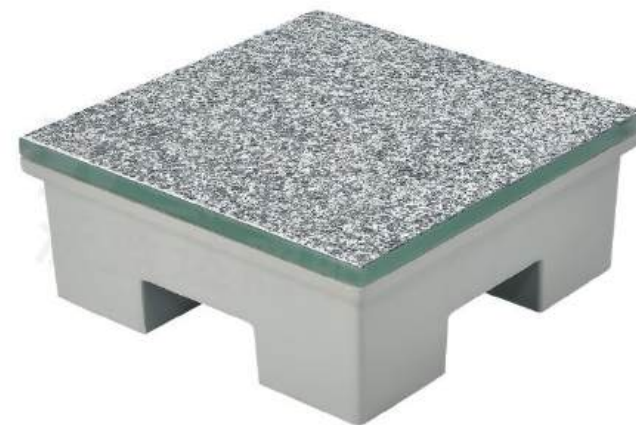

详细参数/SPECIFICATION

光源/Light source:	著名品牌LED光源/famous brand LED light source
常规功率/Conventional power:	6W/15W/24W
工作电压/Voltage:	DC24V/AC220V
灯具寿命/Lamp life:	≥30000H
LED光色/LED color:	R/Y/B/G/W/WW/RGB
色彩效果/Colour effect:	全彩、单色/full colour, monochrome
控制方式/Control mode:	国际标准DMX512/International standard DMX512
防护等级/Protection grade:	IP65
环境温度/Environment temperature:	-30℃~+50℃
发光角度/Light angle:	120°

线条尺寸图/Line size chart

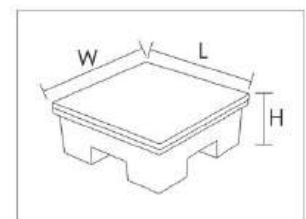

产品细节图/Product detail map



配光曲线图/Light distribution curve

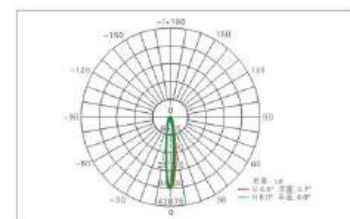

应用场景/Application scenario

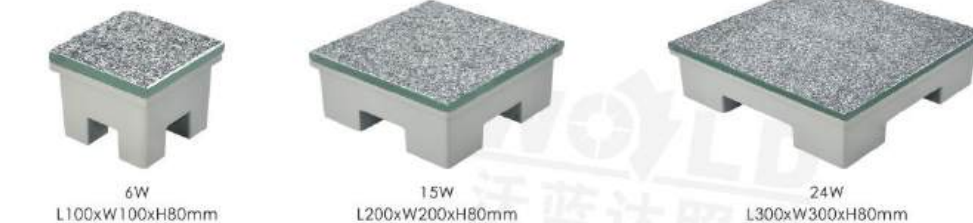
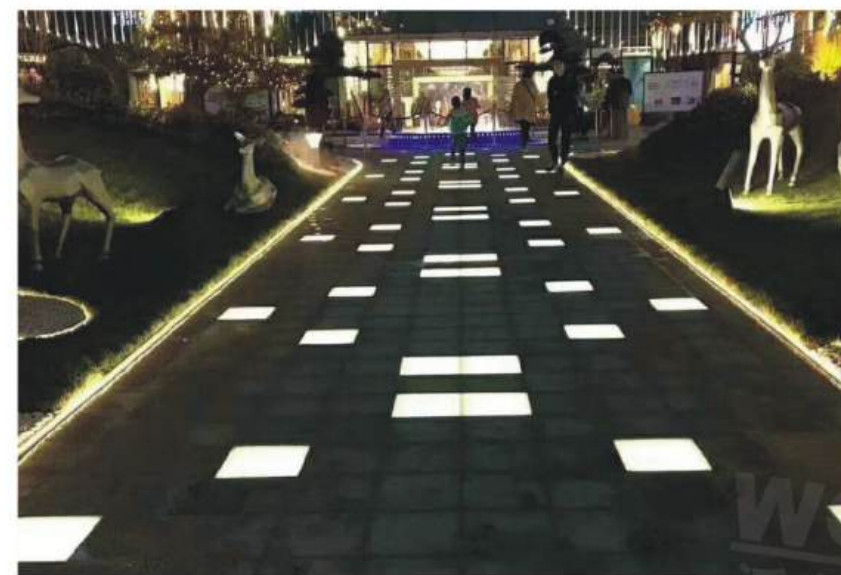

应用场所: 商场、广场、街道、公园、娱乐场所、园林道路、步行街、停车场等地面装饰照明
Application places: Shopping malls, squares, streets, parks, entertainment venues, garden roads, pedestrian streets, parking lots and other ground decoration lighting

LED BURIED LAMP SERIES
LED埋地灯系列



MDD-HL07



MDD-MG08



MDD-MG09



详细参数/SPECIFICATION

光源Light source:	著名品牌LED光源/famous brand LED light source
常规功率Conventional power:	18*1-3W/24*1-3W/36*1-3W/54*1-3W
工作电压/Voltage:	DC24V/AC220V
灯具寿命/Lamp life:	>30000H
LED光色/LED color:	R/Y/B/G/W/WW/RGB
色彩效果/Colour effect:	全彩、单色/full colour, monochrome
防护等级/Protection grade:	IP65
环境温度/Environment temperature:	-30℃~+50℃
发光角度/Light angle:	60° /90° /120°

详细参数/SPECIFICATION

光源Light source:	著名品牌LED光源/famous brand LED light source
常规功率Conventional power:	12W
工作电压/Voltage:	DC24V/AC220V
灯具寿命/Lamp life:	>30000H
LED光色/LED color:	R/Y/B/G/W/WW/RGB
色彩效果/Colour effect:	全彩、单色/full colour, monochrome
防护等级/Protection grade:	IP65
环境温度/Environment temperature:	-30℃~+50℃
发光角度/Light angle:	30° /60° /90° /120°

详细参数/SPECIFICATION

光源Light source:	著名品牌LED光源/famous brand LED light source
常规功率Conventional power:	20W
工作电压/Voltage:	DC24V/AC220V
灯具寿命/Lamp life:	>30000H
LED光色/LED color:	R/Y/B/G/W/WW/RGB
色彩效果/Colour effect:	全彩、单色/full colour, monochrome
防护等级/Protection grade:	IP65
环境温度/Environment temperature:	-30℃~+50℃
发光角度/Light angle:	60° /90° /120°

LED BURIED LAMP SERIES
LED埋地灯系列



MDD-010



MDD-011



MDD-012



详细参数/SPECIFICATION

光源Light source:	著名品牌LED光源/famous brand LED light source
常规功率Conventional power:	10W/20W/30W/40W
工作电压/Voltage:	DC24V/AC220V
灯具寿命/Lamp life:	>30000H
LED光色/LED color:	R/Y/B/G/W/WW/RGB
色彩效果/Colour effect:	全彩、单色/full colour, monochrome
防护等级/Protection grade:	IP65
环境温度/Environment temperature:	-30℃~+50℃
发光角度/Light angle:	120°

详细参数/SPECIFICATION

光源Light source:	著名品牌LED光源/famous brand LED light source
常规功率Conventional power:	1W/3W/5W/6W/9W/12W/15W/18W/24W
工作电压/Voltage:	DC24V/AC220V
灯具寿命/Lamp life:	>30000H
LED光色/LED color:	R/Y/B/G/W/WW/RGB
色彩效果/Colour effect:	全彩、单色/full colour, monochrome
防护等级/Protection grade:	IP65
环境温度/Environment temperature:	-30℃~+50℃
发光角度/Light angle:	30° /60° /90°

详细参数/SPECIFICATION

光源Light source:	著名品牌LED光源/famous brand LED light source
常规功率Conventional power:	4W/5W/6W/9W/12W/16W/24W
工作电压/Voltage:	DC24V/AC220V
灯具寿命/Lamp life:	>30000H
LED光色/LED color:	R/Y/B/G/W/WW/RGB
色彩效果/Colour effect:	全彩、单色/full colour, monochrome
防护等级/Protection grade:	IP65
环境温度/Environment temperature:	-30℃~+50℃
发光角度/Light angle:	30° /60° /90°

LED BURIED LAMP SERIES
LED埋地灯系列



MDD-013

详细参数/SPECIFICATION

光源Light source:
著名品牌LED光源
常规功率Conventional power:
1W
工作电压/Voltage:
DC24V/AC220V
灯具寿命/Lamp life:
>30000H
LED光色/LED color:
R/Y/B/G/W/WW/RGB
色彩效果/Colour effect:
全彩、单色/full colour, monochrome
防护等级/Protection grade:
IP65
环境温度/Environment temperature:
-30℃~+50℃
灯具材质/Lamp material:
不锈钢/SS

线条尺寸图/Line size chart

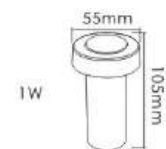

MDD-014

详细参数/SPECIFICATION

光源Light source:
著名品牌LED光源
常规功率Conventional power:
1W
工作电压/Voltage:
DC24V/AC220V
灯具寿命/Lamp life:
>30000H
LED光色/LED color:
R/Y/B/G/W/WW/RGB
色彩效果/Colour effect:
全彩、单色/full colour, monochrome
防护等级/Protection grade:
IP65
环境温度/Environment temperature:
-30℃~+50℃
灯具材质/Lamp material:
铝材+不锈钢/AL+SS

线条尺寸图/Line size chart

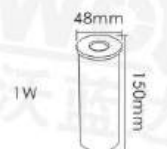

MDD-015

详细参数/SPECIFICATION

光源Light source:
著名品牌LED光源
常规功率Conventional power:
3W
工作电压/Voltage:
DC24V/AC220V
灯具寿命/Lamp life:
>30000H
LED光色/LED color:
R/Y/B/G/W/WW/RGB
色彩效果/Colour effect:
全彩、单色/full colour, monochrome
防护等级/Protection grade:
IP65
环境温度/Environment temperature:
-30℃~+50℃
灯具材质/Lamp material:
铝材+不锈钢/AL+SS

线条尺寸图/Line size chart



MDD-016

详细参数/SPECIFICATION

光源Light source:
著名品牌LED光源
常规功率Conventional power:
5W
工作电压/Voltage:
DC24V/AC220V
灯具寿命/Lamp life:
>30000H
LED光色/LED color:
R/Y/B/G/W/WW/RGB
色彩效果/Colour effect:
全彩、单色/full colour, monochrome
防护等级/Protection grade:
IP65
环境温度/Environment temperature:
-30℃~+50℃
灯具材质/Lamp material:
铝材+不锈钢/AL+SS

线条尺寸图/Line size chart

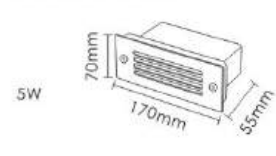

LED BURIED LAMP SERIES
LED埋地灯系列

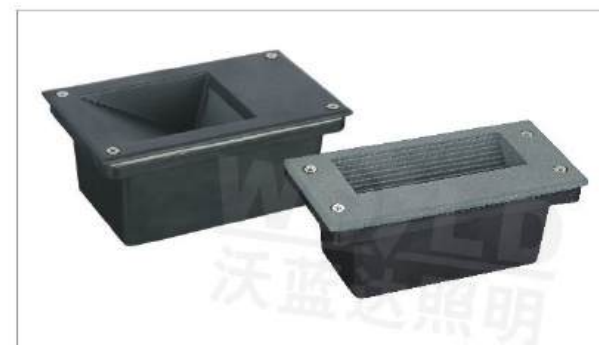

MDD-017

详细参数/SPECIFICATION

光源Light source:
著名品牌LED光源
常规功率Conventional power:
3W
工作电压/Voltage:
DC24V/AC220V
灯具寿命/Lamp life:
>30000H
LED光色/LED color:
R/Y/B/G/W/WW/RGB
色彩效果/Colour effect:
全彩、单色/full colour, monochrome
防护等级/Protection grade:
IP65
环境温度/Environment temperature:
-30℃~+50℃
灯具材质/Lamp material:
铝材+钢化玻璃/AL+TG

线条尺寸图/Line size chart

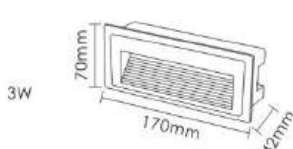

MDD-018

详细参数/SPECIFICATION

光源Light source:
著名品牌LED光源
常规功率Conventional power:
3W
工作电压/Voltage:
DC24V/AC220V
灯具寿命/Lamp life:
>30000H
LED光色/LED color:
R/Y/B/G/W/WW/RGB
色彩效果/Colour effect:
全彩、单色/full colour, monochrome
防护等级/Protection grade:
IP65
环境温度/Environment temperature:
-30℃~+50℃
灯具材质/Lamp material:
铝材+钢化玻璃/AL+TG

线条尺寸图/Line size chart

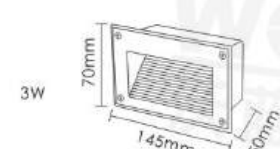

MDD-019

详细参数/SPECIFICATION

光源Light source:
著名品牌LED光源
常规功率Conventional power:
9W
工作电压/Voltage:
DC24V/AC220V
灯具寿命/Lamp life:
>30000H
LED光色/LED color:
R/Y/B/G/W/WW/RGB
色彩效果/Colour effect:
全彩、单色/full colour, monochrome
防护等级/Protection grade:
IP65
环境温度/Environment temperature:
-30℃~+50℃
灯具材质/Lamp material:
不锈钢+钢化玻璃/SS+TG

线条尺寸图/Line size chart

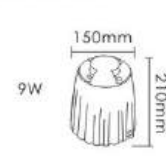

MDD-020

详细参数/SPECIFICATION

光源Light source:
著名品牌LED光源
常规功率Conventional power:
15W/35W
工作电压/Voltage:
DC24V/AC220V
灯具寿命/Lamp life:
>30000H
LED光色/LED color:
R/Y/B/G/W/WW/RGB
色彩效果/Colour effect:
全彩、单色/full colour, monochrome
防护等级/Protection grade:
IP65
环境温度/Environment temperature:
-30℃~+50℃
灯具材质/Lamp material:
铝材+钢化玻璃/AL+TG

线条尺寸图/Line size chart



LED TRAIL LIGHTS SERIES
LED步道灯系列



BDD-QB01

详细参数/SPECIFICATION

光源/Light source:	著名品牌LED光源/famous brand LED light source
常规功率/Conventional power:	3W
灯具尺寸/Lamp size:	Ø120xH40mm
工作电压/Voltage:	DC24V/AC220V
灯具寿命/Lamp life:	≥30000H
LED光色/LED color:	R/Y/B/G/W/WW/RGB
色彩效果/Colour effect:	全彩、单色/full colour, monochrome
控制方式/Control mode:	国际标准DMX512/International standard DMX512
防护等级/Protection grade:	IP65
环境温度/Environment temperature:	-30℃~+50℃
发光角度/Light angle:	15° /30° /45°



线条尺寸图/Line size chart | 产品细节图/Product detail map | 配光曲线图/Light distribution curve | 应用场景/Application scenario

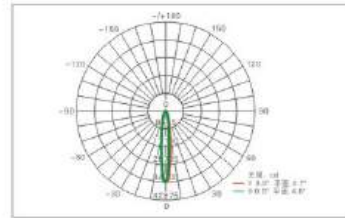
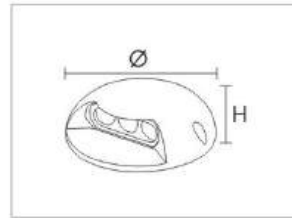

表面处理: 表面经阳极氧化、户外等级喷涂处理
Surface treatment: The surface is sprayed by anodic oxidation and outdoor grade

灯具材质: 采用优质航空铝材成型, 不锈钢螺丝, 钢化玻璃面盖
Lamp material: Adopt high quality aviation aluminum material forming, stainless steel screw, toughened glass cover

应用场所: 公园、游乐场、广场、街道、行人隧道、天桥等阶梯装饰照明
Application: park, playground, square, street, pedestrian tunnel, bridge and other stairs decorative lighting

LED TRAIL LIGHTS SERIES
LED步道灯系列



BDD-002

常规功率Conventional power:	5W
工作电压/Voltage:	DC24V
LED光色/LED color:	R/Y/B/G/W/WW/RGB
防护等级/Protection grade:	IP65
发光角度/Light angle:	3° /8° /12° /24° /36° /60°

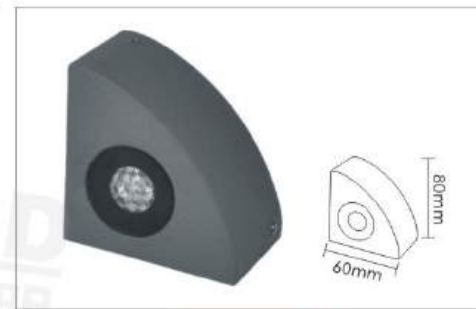

BDD-003

常规功率Conventional power:	5W
工作电压/Voltage:	DC24V
LED光色/LED color:	R/Y/B/G/W/WW/RGB
防护等级/Protection grade:	IP65
发光角度/Light angle:	3° /8° /12° /24° /36° /60°

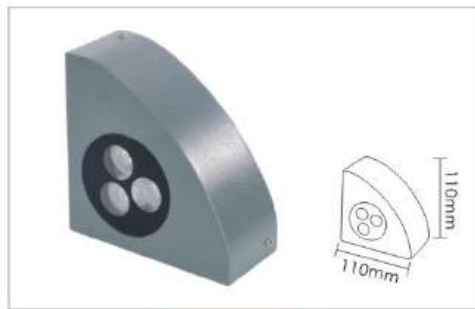

BDD-004

常规功率Conventional power:	3*3W
工作电压/Voltage:	DC24V
LED光色/LED color:	R/Y/B/G/W/WW/RGB
防护等级/Protection grade:	IP65
发光角度/Light angle:	3° /8° /12° /24° /36° /60°

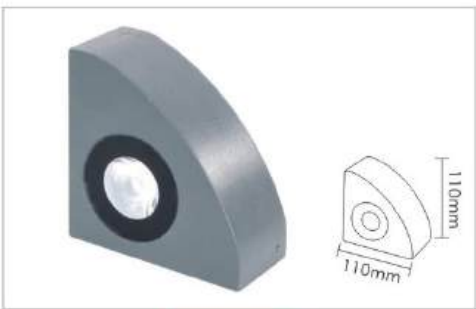

BDD-005

常规功率Conventional power:	10W
工作电压/Voltage:	DC24V
LED光色/LED color:	R/Y/B/G/W/WW/RGB
防护等级/Protection grade:	IP65
发光角度/Light angle:	3° /8° /12° /24° /36° /60°

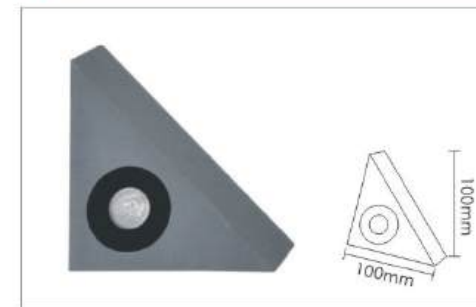

BDD-006

常规功率Conventional power:	5W
工作电压/Voltage:	DC24V
LED光色/LED color:	R/Y/B/G/W/WW/RGB
防护等级/Protection grade:	IP65
发光角度/Light angle:	3° /8° /12° /24° /36° /60°

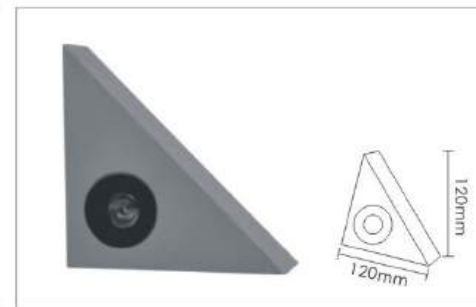

BDD-007

常规功率Conventional power:	5W
工作电压/Voltage:	DC24V
LED光色/LED color:	R/Y/B/G/W/WW/RGB
防护等级/Protection grade:	IP65
发光角度/Light angle:	3° /8° /12° /24° /36° /60°

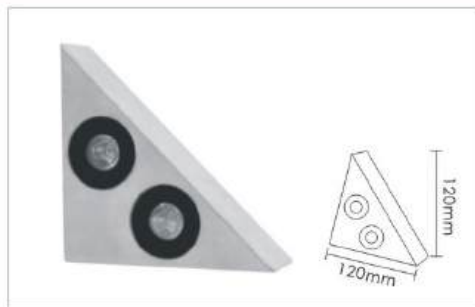

BDD-008

常规功率Conventional power:	2*3W
工作电压/Voltage:	DC24V
LED光色/LED color:	R/Y/B/G/W/WW/RGB
防护等级/Protection grade:	IP65
发光角度/Light angle:	3° /8° /12° /24° /36° /60°

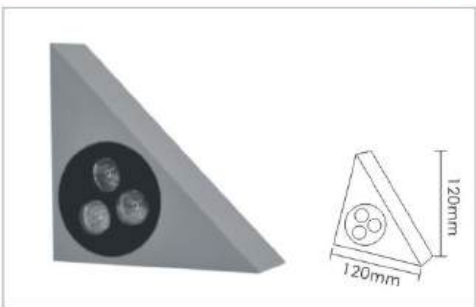

BDD-009

常规功率Conventional power:	3*2W
工作电压/Voltage:	DC24V
LED光色/LED color:	R/Y/B/G/W/WW/RGB
防护等级/Protection grade:	IP65
发光角度/Light angle:	3° /8° /12° /24° /36° /60°



WORLD
沃蓝达照明



WORLD
沃蓝达照明

产品特点

- 灯体采用优质铝材制作，阳极氧化拉伸反射器、拉伸散热器，散热性能优越。
- 采用进口高亮度单颗大功率LED光源，具有导热率高，光衰小，光色纯，无重影等特点
- 内置高功率恒流驱动电源，灯体内散热铝基板厚实、散热优良，确保高效节能，寿命可达50,000小时，长时间稳定工作；
- 防腐、防水、防尘，性能好；

适用范围

广泛应用于车间、库房、工厂厂房、大型超市、车站、大型仓库、收费站、加油站、展览馆、体育馆、工矿区及其它需要较高要求的半户外、室内场合。

Product features

- In pieces the lamp body made of high-quality aluminum anodic oxidation tensile reflector, stretching the radiator, heat dissipation performance is superior.
- Pieces of imported high brightness single high power LED light source, with high thermal conductivity, light failure is small, light color purity, no ghosting, etc.
- Built-in high power constant current drive power supply, light body heat dissipation aluminum plate thick, good heat dissipation, ensure high efficiency and energy saving, service life of up to 50000 hours, work stably for a long time;
- anticorrosive, waterproof, dustproof, performance is good;

Scope of application

Widely used in workshop, warehouse, factory workshop, large supermarket, station, large warehouse, toll station, gas stations, exhibition hall, gymnasium, industrial and mining areas, and other needs higher requirements half outdoor and indoor places.

WORLD
沃蓝达照明

WORLD
沃蓝达照明

选材·解析



防水可调驱动

采用明纬驱动电源，带IC智能控制，确保电流稳定，开路、短路、过压欠压、过载自动保护。



铝材固定支架

高强度优质铝材制作，可承重量高达20KG，抗腐蚀、防生锈、耐高温，使用更安全。



全铜三芯线材

国标三芯全铜线材，导电强，功率高，线材柔软，不易折断，专业稳流，耐候性强，防雷击。



航空铝材灯体

采用高强度超厚精工航空铝材，表面经阳极氧化处理，散热好，抗腐蚀、抗开裂、防生锈、经久耐用不褪色。



不锈钢螺丝

采用不锈钢材质，高强度不易滑，不易腐蚀生锈，防损坏，加强面盖部位防水性能。



高亮LED芯片

采用高亮芯片，亮度高、低功耗、高流明，在各种气候条件下仍能长时间稳定工作，寿命更长。



航空铝材灯罩

高强度优质铝材一体化旋压成型，经阳极氧化磨砂工艺，防雾、防尘、防霜、抗腐蚀，耐用、抗生锈、安全放心。



鳍片散热器

加厚航空铝材精工压铸，打造鳍片散热系统，上下贯通散热设计，完美解决灯具散热问题，大大延长灯具寿命。



GKD-YX01

详细参数/SPECIFICATION

光源/Light source:	著名品牌LED光源/famous brand LED light source
常规功率/Conventional power:	160W/240W/320W/400W
工作电压/Voltage:	AC85-265V
灯具寿命/Lamp life:	≥30000H
LED光色/LED color:	W/WW
色彩效果/Colour effect:	单色/Monochrome
灯具材质/Material:	铝材+钢化玻璃/AL+TG
防护等级/Protection grade:	IP65
环境温度/Environment temperature:	-30℃~+50℃
发光角度/Light angle:	120°



线条尺寸图/Line size chart

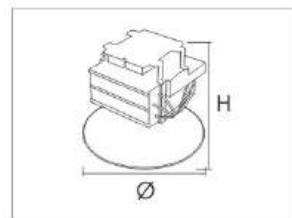

产品细节图/Product detail map



配光曲线图/Light distribution curve

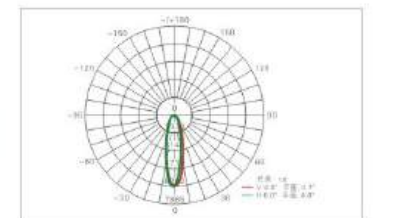

应用场景/Application scenario

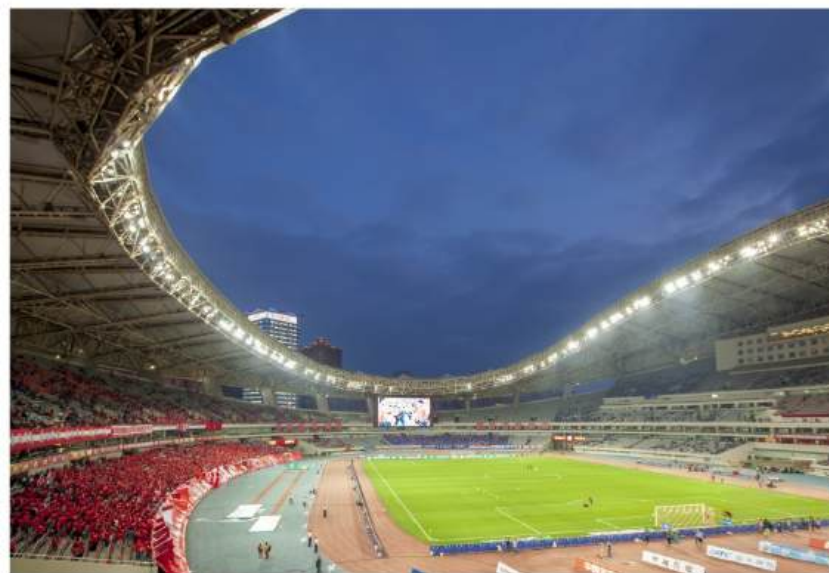

应用场所: 大型仓库、厂房、大型超市、车站、收费站、加油站、展览馆、体育馆、球场及其它需要较高要求的半户外、室内场合
Application places: Large warehouses, factories, large supermarkets, stations, toll stations, gas stations, exhibition halls, stadiums, stadiums and other semi-outdoor, indoor occasions requiring high requirements



GKD-YX02

详细参数/SPECIFICATION

光源/Light source:	著名品牌LED光源/famous brand LED light source
常规功率/Conventional power:	300W/500W/1000W
工作电压/Voltage:	AC85-265V
灯具寿命/Lamp life:	≥30000H
LED光色/LED color:	W/WW
色彩效果/Colour effect:	单色/Monochrome
灯具材质/Material:	铝材+钢化玻璃/AL+TG
防护等级/Protection grade:	IP65
环境温度/Environment temperature:	-30℃~+50℃
发光角度/Light angle:	90°



线条尺寸图/Line size chart

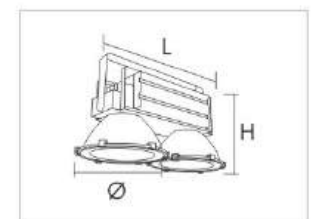

产品细节图/Product detail map



配光曲线图/Light distribution curve

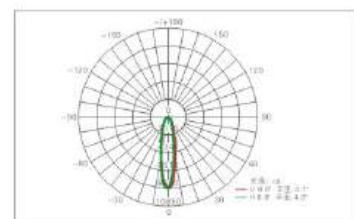

应用场景/Application scenario



应用场所: 大型仓库、厂房、大型超市、车站、收费站、加油站、展览馆、体育馆、球场及其它需要较高要求的半户外、室内场合
Application places: Large warehouses, factories, large supermarkets, stations, toll stations, gas stations, exhibition halls, stadiums, stadiums and other semi-outdoor, indoor occasions requiring high requirements



GKD-KR03

详细参数/SPECIFICATION

光源/Light source:	著名品牌LED光源/famous brand LED light source
常规功率/Conventional power:	100W/150W/200W
工作电压/Voltage:	AC85-265V
灯具寿命/Lamp life:	≥30000H
LED光色/LED color:	W/WW
色彩效果/Colour effect:	单色/Monochrome
灯具材质/Material:	铝材/AL
防护等级/Protection grade:	IP65
环境温度/Environment temperature:	-30℃~+50℃
发光角度/Light angle:	90°



线条尺寸图/Line size chart

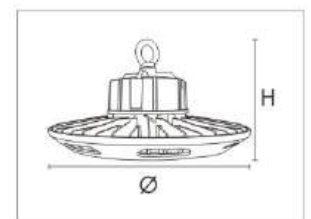

产品细节图/Product detail map



配光曲线图/Light distribution curve

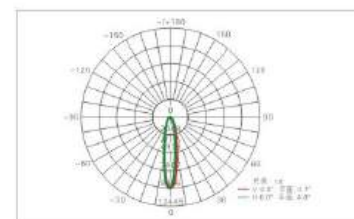

应用场景/Application scenario

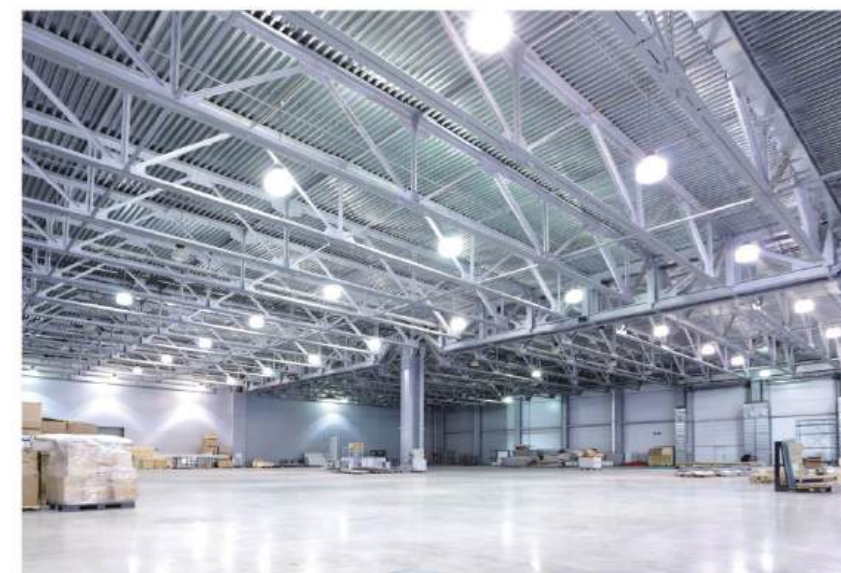

应用场所: 大型仓库、厂房、大型超市、车站、收费站、加油站、展览馆、体育馆、球场及其它需要较高要求的半户外、室内场合
Application places: Large warehouses, factories, large supermarkets, stations, toll stations, gas stations, exhibition halls, stadiums, stadiums and other semi-outdoor, indoor occasions requiring high requirements



GKD-KR04

详细参数/SPECIFICATION

光源/Light source:	著名品牌LED光源/famous brand LED light source
常规功率/Conventional power:	100W/150W/200W
工作电压/Voltage:	AC85-265V
灯具寿命/Lamp life:	>30000H
LED光色/LED color:	W/WW
色彩效果/Colour effect:	单色/Monochrome
灯具材质/Material:	铝材/AL
防护等级/Protection grade:	IP65
环境温度/Environment temperature:	-30℃~+50℃
发光角度/Light angle:	90°

线条尺寸图/Line size chart

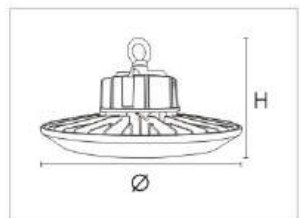

产品细节图/Product detail map



配光曲线图/Light distribution curve

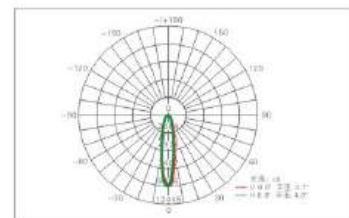

应用场景/Application scenario



应用场所: 大型仓库、厂房、大型超市、车站、收费站、加油站、展览馆、体育馆、球场及其它需要较高要求的半户外、室内场合
Application places: Large warehouses, factories, large supermarkets, stations, toll stations, gas stations, exhibition halls, stadiums, stadiums and other semi-outdoor, indoor occasions requiring high requirements



WLD-005



WLD-006



WLD-007



详细参数/SPECIFICATION

光源/Light source:	著名品牌LED光源/famous brand LED light source
常规功率/Conventional power:	100W/150W/200W
工作电压/Voltage:	AC85-265V
灯具寿命/Lamp life:	>30000H
LED光色/LED color:	W/WW
色彩效果/Colour effect:	单色/Monochrome
防护等级/Protection grade:	IP65
环境温度/Environment temperature:	-30℃~+50℃
发光角度/Light angle:	90° /140°

详细参数/SPECIFICATION

光源/Light source:	著名品牌LED光源/famous brand LED light source
常规功率/Conventional power:	100W/150W/200W
工作电压/Voltage:	AC85-265V
灯具寿命/Lamp life:	>30000H
LED光色/LED color:	W/WW
色彩效果/Colour effect:	单色/Monochrome
防护等级/Protection grade:	IP65
环境温度/Environment temperature:	-30℃~+50℃
发光角度/Light angle:	90° /140°

详细参数/SPECIFICATION

光源/Light source:	著名品牌LED光源/famous brand LED light source
常规功率/Conventional power:	100W/150W/200W
工作电压/Voltage:	AC85-265V
灯具寿命/Lamp life:	>30000H
LED光色/LED color:	W/WW
色彩效果/Colour effect:	单色/Monochrome
防护等级/Protection grade:	IP65
环境温度/Environment temperature:	-30℃~+50℃
发光角度/Light angle:	90° /140°



HLD-001

详细参数/SPECIFICATION

光源/Light source:	著名品牌LED光源/famous brand LED light source
常规功率/Conventional power:	12W+6W
灯具尺寸/Lamp size:	L2000xØ114xH300mm
工作电压/Voltage:	DC24/AC220V
灯具寿命/Lamp life:	≥30000H
LED光色/LED color:	R/Y/B/G/W/WW/RGB
色彩效果/Colour effect:	全彩、单色/full colour, monochrome
灯具材质/Material:	铝材+钢化玻璃/AL+TG
防护等级/Protection grade:	IP65
环境温度/Environment temperature:	-30℃~+50℃
发光角度/Light angle:	25°140°



线条尺寸图/Line size chart

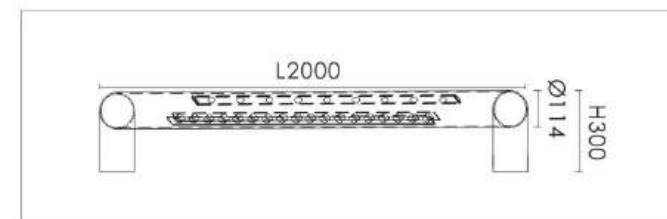

配光曲线图/Light distribution curve

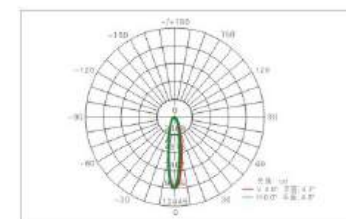

应用场景/Application scenario



表面处理: 抗紫外线聚酯粉, 户外等级喷涂
Surface treatment: anti-ultraviolet polyester powder, spray outdoor level

灯具材质: 铝合金灯体, IP65防水, 不锈钢螺丝
Lamp material: Aluminum alloy lamp body, IP65 waterproof, stainless steel screws

应用场所: 立交桥、河护栏、湖护栏、道路护栏
Application places: Overpass, river guardrail, lake guardrail, road rail



绿色照明 节能环保 超长寿命 高显色性 温度极低

SWD-001

详细参数/SPECIFICATION

光源/Light source:	著名品牌LED光源/famous brand LED light source
常规功率/Conventional power:	24W/36W/48W
灯具尺寸/Lamp size:	L1000xW85xH86mm
工作电压/Voltage:	DC24/AC220V
灯具寿命/Lamp life:	≥30000H
LED光色/LED color:	R/Y/B/G/W/WW/RGB
色彩效果/Colour effect:	全彩、单色/full colour, monochrome
灯具材质/Material:	铝材+钢化玻璃/AL+TG
防护等级/Protection grade:	IP65
环境温度/Environment temperature:	-30℃~+50℃
发光角度/Light angle:	30°



线条尺寸图/Line size chart

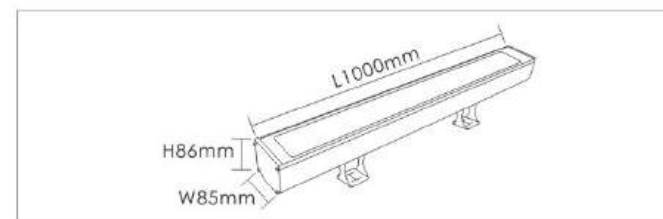

配光曲线图/Light distribution curve

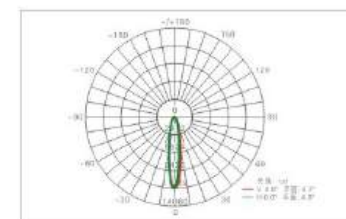

应用场景/Application scenario



表面处理: 抗紫外线聚酯粉, 户外等级喷涂
Surface treatment: anti-ultraviolet polyester powder, spray outdoor level

灯具材质: 铝合金灯体, IP65防水, 不锈钢螺丝
Lamp material: Aluminum alloy lamp body, IP65 waterproof, stainless steel screws

应用场所: 楼体墙面, 景点地面, 桥梁等水纹投影
Application places: The wall of the building, the ground of the scenic spot, the water pattern projection of the bridge, etc



产品特点

- 采用精工优质压铸铝灯体，确保了良好的散热效果，表面聚酯粉末喷涂，抗老化、自洁、不褪色、抗腐蚀性强；
- 硅胶密封胶圈、防水等级高达IP66，能适应各种温湿度环境。
- 采用高品质国际品牌LED芯片，高光效、低光衰、寿命长、色彩纯正、显色指数高；
- 配合局放光学透镜，光色均匀，效果更出彩；
- 采用低压直流电源供电，安全可靠，配合DMX512控制系统能达到多种颜色任意变化效果。

适用范围

广泛应用于琉璃瓦、景区屋檐、古建筑物、建筑立面、广场、休闲运动场、舞台、广告牌、假山、桥梁、房顶、桥梁、高楼大厦、公共场所、别墅小区、公园景观装饰等轮廓、像素点、投光照明、室外楼宇、景观建筑物楼体

Product features

- The use of high quality precision die-cast aluminum lamp body, to ensure good heat dissipation effect, surface polyester powder spraying, anti-aging, self-cleaning, fadeless, strong corrosion resistance;
- Silicone sealing ring, waterproof grade up to IP66, can adapt to a variety of temperature and humidity environment;
- The use of high-quality international brand LED chip, high light efficiency, low light failure, long life, pure color, high color index;
- Cooperate with local effect optical lens, uniform light color, more brilliant effect;
- Low voltage dc power supply, safe and reliable, with DMX512 control system can achieve a variety of arbitrary color change effect.

Scope of application

Widely used in glazed tile, scenic area eaves, ancient buildings, building facades, square, leisure sports field, stage, billboards, rockery, bridge, roof, bridge, high-rise buildings, public places, Villa community, park landscape decoration and other contours, pixels, projection lighting, outdoor buildings, landscape buildings



WLD-LL01

详细参数/SPECIFICATION

光源/Light source:	著名品牌LED光源/famous brand LED light source
常规功率/Conventional power:	6W
灯具尺寸/Lamp size:	L190xH91mm
工作电压/Voltage:	DC24V
灯具寿命/Lamp life:	≥30000H
LED光色/LED color:	R/Y/B/G/W/WW/RGB
色彩效果/Colour effect:	全彩、单色/full colour, monochrome
控制方式/Control mode:	国际标准DMX512/International standard DMX512
防护等级/Protection grade:	IP65
环境温度/Environment temperature:	-30℃~+50℃
发光角度/Light angle:	15° /30° /45° /60° /90° /120°

线条尺寸图/Line size chart

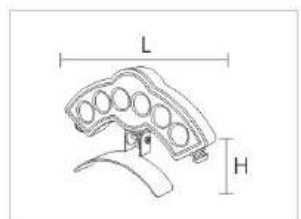

产品细节图/Product detail map



配光曲线图/Light distribution curve

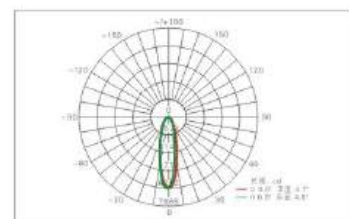

应用场景/Application scenario



表面处理: 表面经阳极氧化、户外等级喷涂处理
Surface treatment: The surface is sprayed by anodic oxidation and outdoor grade

灯具材质: 采用优质航空铝材成型
Lamp material: Use high quality aviation aluminum to form

应用场所: 琉璃瓦、景区屋檐、古建筑、舞台、广告牌、假山、桥梁、房顶、桥梁、别墅小区、公园景观装饰等
Application places: Glazed tile, scenic area eaves, ancient buildings, stage, billboards, rockery, bridge, roof, bridge, villa community, park landscape decoration, etc



WLD-BT02

详细参数/SPECIFICATION

光源/Light source:	著名品牌LED光源/famous brand LED light source
常规功率/Conventional power:	5W
灯具尺寸/Lamp size:	L190xH91mm
工作电压/Voltage:	DC24V
灯具寿命/Lamp life:	≥30000H
LED光色/LED color:	R/Y/B/G/W/WW/RGB
色彩效果/Colour effect:	全彩、单色/full colour, monochrome
控制方式/Control mode:	国际标准DMX512/International standard DMX512
防护等级/Protection grade:	IP65
环境温度/Environment temperature:	-30℃~+50℃
发光角度/Light angle:	15° /30° /45° /60° /90° /120°

线条尺寸图/Line size chart

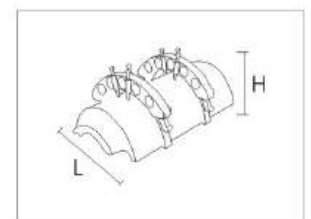

产品细节图/Product detail map



配光曲线图/Light distribution curve

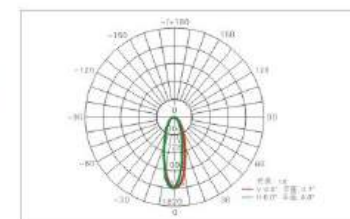

应用场景/Application scenario



表面处理: 表面经阳极氧化、户外等级喷涂处理
Surface treatment: The surface is sprayed by anodic oxidation and outdoor grade

灯具材质: 采用优质航空铝材成型
Lamp material: Use high quality aviation aluminum to form

应用场所: 琉璃瓦、景区屋檐、古建筑、舞台、广告牌、假山、桥梁、房顶、桥梁、别墅小区、公园景观装饰等
Application places: Glazed tile, scenic area eaves, ancient buildings, stage, billboards, rockery, bridge, roof, bridge, villa community, park landscape decoration, etc

LED CORRUGATED LAMP SERIES
LED瓦楞灯系列



WLD-LL03



3W
L110xW42xH75mm

详细参数/SPECIFICATION

光源Light source:	著名品牌LED光源/famous brand LED light source
常规功率Conventional power:	3W
工作电压/Voltage:	DC24V
灯具寿命/Lamp life:	>30000H
LED光色/LED color:	R/Y/B/G/W/WW/RGB
色彩效果/Colour effect:	全彩、单色/full colour, monochrome
防护等级/Protection grade:	IP65
环境温度/Environment temperature:	-30℃~+50℃
发光角度/Light angle:	15° /30° /45° /60° /90° /120°



WLD-LL04



6W/9W
L180xW116xH138mm

详细参数/SPECIFICATION

光源Light source:	著名品牌LED光源/famous brand LED light source
常规功率Conventional power:	6W/9W
工作电压/Voltage:	DC24V
灯具寿命/Lamp life:	>30000H
LED光色/LED color:	R/Y/B/G/W/WW/RGB
色彩效果/Colour effect:	全彩、单色/full colour, monochrome
防护等级/Protection grade:	IP65
环境温度/Environment temperature:	-30℃~+50℃
发光角度/Light angle:	15° /30° /45° /60° /90° /120°



WLD-PQ05



6W
L180xW90mm

详细参数/SPECIFICATION

光源Light source:	著名品牌LED光源/famous brand LED light source
常规功率Conventional power:	6W
工作电压/Voltage:	DC24V
灯具寿命/Lamp life:	>30000H
LED光色/LED color:	R/Y/B/G/W/WW/RGB
色彩效果/Colour effect:	全彩、单色/full colour, monochrome
防护等级/Protection grade:	IP65
环境温度/Environment temperature:	-30℃~+50℃
发光角度/Light angle:	15° /30° /45° /60° /90° /120°



LED CORRUGATED LAMP SERIES
LED瓦楞灯系列



WLD-PQ06



12W
L205xW50xH150mm

详细参数/SPECIFICATION

光源Light source:	著名品牌LED光源/famous brand LED light source
常规功率Conventional power:	12W
工作电压/Voltage:	DC24V
灯具寿命/Lamp life:	>30000H
LED光色/LED color:	R/Y/B/G/W/WW/RGB
色彩效果/Colour effect:	全彩、单色/full colour, monochrome
防护等级/Protection grade:	IP65
环境温度/Environment temperature:	-30℃~+50℃
发光角度/Light angle:	15° /30° /45° /60° /90° /120°



WLD-PQ07



8W
L150xW165xH70mm

详细参数/SPECIFICATION

光源Light source:	著名品牌LED光源/famous brand LED light source
常规功率Conventional power:	8W
工作电压/Voltage:	DC24V
灯具寿命/Lamp life:	>30000H
LED光色/LED color:	R/Y/B/G/W/WW/RGB
色彩效果/Colour effect:	全彩、单色/full colour, monochrome
防护等级/Protection grade:	IP65
环境温度/Environment temperature:	-30℃~+50℃
发光角度/Light angle:	15° /30° /45° /60° /90° /120°



WLD-PQ08



6W
L210xW45xH100mm

详细参数/SPECIFICATION

光源Light source:	著名品牌LED光源/famous brand LED light source
常规功率Conventional power:	6W
工作电压/Voltage:	DC24V
灯具寿命/Lamp life:	>30000H
LED光色/LED color:	R/Y/B/G/W/WW/RGB
色彩效果/Colour effect:	全彩、单色/full colour, monochrome
防护等级/Protection grade:	IP65
环境温度/Environment temperature:	-30℃~+50℃
发光角度/Light angle:	15° /30° /45° /60° /90° /120°



产品特点
 • LED抱树灯正如其名，就是“抱着树的灯”，因为它的形状，正好是设计为可以环绕树干的空心圆柱形，安装在树干下，就像拥抱着树的样子，像护栏一样安装在灯柱下，整齐、美观，光照效果好。
 • LED抱树灯是分段组合的。

适用范围
 广泛应用于树木、园林景观或是柱状物体的景观照明上。

Product features

• As the name implies, the LED tree-holding lamp is "the lamp holding the tree". Because of its shape, it is designed to be a hollow cylinder around the trunk, which is installed under the trunk, just like hugging the tree, and installed under the lamp post like a guardrail, which is neat and beautiful with good lighting effect.
 • LED tree holding lights are segmented.

Scope of application

widely used in trees, landscape or columnar objects landscape lighting.



BSD-PQ01

详细参数/SPECIFICATION

光源/Light source:	著名品牌LED光源/famous brand LED light source
常规功率/Conventional power:	12Wx6
灯具尺寸/Lamp size:	Ø515xH75mm,内直径: Ø400mm
工作电压/Voltage:	DC24V/AC85-265V
灯具寿命/Lamp life:	≥30000H
LED光色/LED color:	R/Y/B/G/W/WW/RGB
色彩效果/Colour effect:	全彩、单色/full colour, monochrome
控制方式/Control mode:	国际标准DMX512/International standard DMX512
防护等级/Protection grade:	IP65
环境温度/Environment temperature:	-30℃~+50℃
发光角度/Light angle:	15° /30° /60° /90°



线条尺寸图/Line size chart



产品细节图/Product detail map



配光曲线图/Light distribution curve

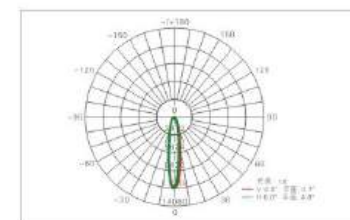

应用场景/Application scenario



表面处理: 表面经阳极氧化、户外等级喷涂处理
 Surface treatment: The surface is sprayed by anodic oxidation and outdoor grade

灯具材质: 采用优质航空铝材成型, 钢化玻璃面盖
 Lamp material: Use high quality aviation aluminum to form, steel glass face cover

应用场所: 树木、园林景观或是柱状物体的景观照明上
 Application places: Landscape lighting for trees, landscaping or columnar objects

LED HOLDING TREE LAMP SERIES
LED抱树灯系列



BSD-LL02

详细参数/SPECIFICATION

光源/Light source:	著名品牌LED光源/famous brand LED light source
常规功率/Conventional power:	12W/18W(单组)
灯具尺寸/Lamp size:	L250xW65xH80mm(单组),内直径: Ø400/500mm
工作电压/Voltage:	DC24V/AC85-265V
灯具寿命/Lamp life:	≥30000H
LED光色/LED color:	R/Y/B/G/W/WW/RGB
色彩效果/Colour effect:	全彩、单色/full colour, monochrome
控制方式/Control mode:	国际标准DMX512/International standard DMX512
防护等级/Protection grade:	IP65
环境温度/Environment temperature:	-30℃~+50℃
发光角度/Light angle:	15° /30° /60° /90°



线条尺寸图/Line size chart

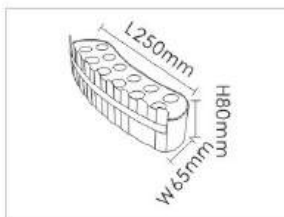

产品细节图/Product detail map



配光曲线图/Light distribution curve

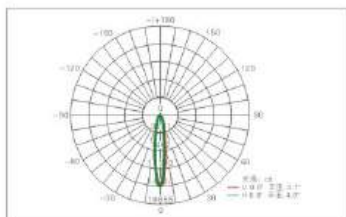

应用场景/Application scenario



表面处理: 表面经阳极氧化、户外等级喷涂处理
Surface treatment: The surface is sprayed by anodic oxidation and outdoor grade

灯具材质: 采用优质航空铝材成型, 钢化玻璃面盖
Lamp material: Use high quality aviation aluminum to form, steel glass face cover

应用场所: 树木、园林景观或是柱状物体的景观照明上
Application places: Landscape lighting for trees, landscaping or columnar objects

LED HOLDING TREE LAMP SERIES
LED抱树灯系列



BSD-PQ03

详细参数/SPECIFICATION

光源/Light source:	著名品牌LED光源/famous brand LED light source
常规功率/Conventional power:	3Wx10
灯具尺寸/Lamp size:	Ø360xH85mm,内直径: Ø275mm
工作电压/Voltage:	DC24V/AC85-265V
灯具寿命/Lamp life:	≥30000H
LED光色/LED color:	R/Y/B/G/W/WW/RGB
色彩效果/Colour effect:	全彩、单色/full colour, monochrome
控制方式/Control mode:	国际标准DMX512/International standard DMX512
防护等级/Protection grade:	IP65
环境温度/Environment temperature:	-30℃~+50℃
发光角度/Light angle:	15° /30° /60° /90°



线条尺寸图/Line size chart

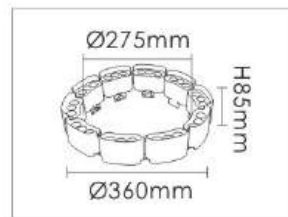

产品细节图/Product detail map



配光曲线图/Light distribution curve

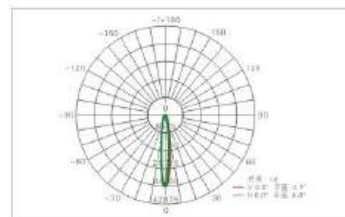

应用场景/Application scenario



表面处理: 表面经阳极氧化、户外等级喷涂处理
Surface treatment: The surface is sprayed by anodic oxidation and outdoor grade

灯具材质: 采用优质航空铝材成型, 钢化玻璃面盖
Lamp material: Use high quality aviation aluminum to form, steel glass face cover

应用场所: 树木、园林景观或是柱状物体的景观照明上
Application places: Landscape lighting for trees, landscaping or columnar objects

LED HOLDING TREE LAMP SERIES
LED抱树灯系列



BSD-PQ04

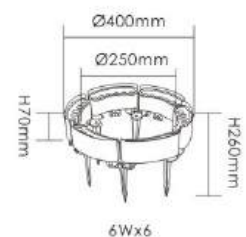

详细参数/SPECIFICATION

光源Light source:	著名品牌LED光源/famous brand LED light source
常规功率Conventional power:	6Wx6
工作电压/Voltage:	DC24V/AC85-265V
灯具寿命/Lamp life:	>30000H
LED光色/LED color:	R/Y/B/G/W/WW/RGB
色彩效果/Colour effect:	全彩、单色/full colour, monochrome
防护等级/Protection grade:	IP65
环境温度/Environment temperature:	-30°C~+50°C
发光角度/Light angle:	15° /30° /60° /90°



BSD-PQ05

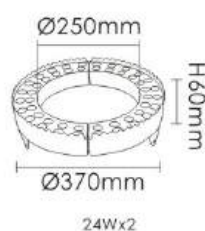

详细参数/SPECIFICATION

光源Light source:	著名品牌LED光源/famous brand LED light source
常规功率Conventional power:	24Wx2
工作电压/Voltage:	DC24V/AC85-265V
灯具寿命/Lamp life:	>30000H
LED光色/LED color:	R/Y/B/G/W/WW/RGB
色彩效果/Colour effect:	全彩、单色/full colour, monochrome
防护等级/Protection grade:	IP65
环境温度/Environment temperature:	-30°C~+50°C
发光角度/Light angle:	15° /30° /60° /90°



BSD-PQ06



详细参数/SPECIFICATION

光源Light source:	著名品牌LED光源/famous brand LED light source
常规功率Conventional power:	12Wx4
工作电压/Voltage:	DC24V/AC85-265V
灯具寿命/Lamp life:	>30000H
LED光色/LED color:	R/Y/B/G/W/WW/RGB
色彩效果/Colour effect:	全彩、单色/full colour, monochrome
防护等级/Protection grade:	IP65
环境温度/Environment temperature:	-30°C~+50°C
发光角度/Light angle:	15° /30° /60° /90°



LED HOLDING TREE LAMP SERIES
LED抱树灯系列



BSD-PQ07



详细参数/SPECIFICATION

光源Light source:	著名品牌LED光源/famous brand LED light source
常规功率Conventional power:	18Wx5
工作电压/Voltage:	DC24V/AC85-265V
灯具寿命/Lamp life:	>30000H
LED光色/LED color:	R/Y/B/G/W/WW/RGB
色彩效果/Colour effect:	全彩、单色/full colour, monochrome
防护等级/Protection grade:	IP65
环境温度/Environment temperature:	-30°C~+50°C
发光角度/Light angle:	15° /30° /60° /90°



BSD-BT08



详细参数/SPECIFICATION

光源Light source:	著名品牌LED光源/famous brand LED light source
常规功率Conventional power:	12Wx4
工作电压/Voltage:	DC24V/AC85-265V
灯具寿命/Lamp life:	>30000H
LED光色/LED color:	R/Y/B/G/W/WW/RGB
色彩效果/Colour effect:	全彩、单色/full colour, monochrome
防护等级/Protection grade:	IP65
环境温度/Environment temperature:	-30°C~+50°C
发光角度/Light angle:	15° /30° /60° /90°



BSD-BT09



详细参数/SPECIFICATION

光源Light source:	著名品牌LED光源/famous brand LED light source
常规功率Conventional power:	6x1W/6x2W (单组)
工作电压/Voltage:	DC24V/AC85-265V
灯具寿命/Lamp life:	>30000H
LED光色/LED color:	R/Y/B/G/W/WW/RGB
色彩效果/Colour effect:	全彩、单色/full colour, monochrome
防护等级/Protection grade:	IP65
环境温度/Environment temperature:	-30°C~+50°C
发光角度/Light angle:	15° /30° /60° /90°

LED WINDOW LIGHT SERIES LED窗台灯系列



产品特点

- 灯体：优质铝材压铸成型，加厚外壳具有散热快，防震抗压，防爆，耐用，表面聚酯粉末喷涂，不褪色；
- 光源：进口集成LED芯片，光衰小，流明高，光线柔和；
- 透镜：超聚光透镜，透光率高达95%以上，抗紫外线，自主配光，线形光斑，无叠影、被照窗台玻璃无余光，采用防爆处理，提高用灯安全；
- 控制光污染：有单色、有彩光变色；
- 防护：一体成型防水设计，由内到外硅胶密封处理，防水防尘，大大提高灯体的防水性能，使用范围更广，更安全；
- 可按不同窗户尺寸来生产，大光斑、小光斑；
- 安装方式：明装式，嵌入式（暗装）选择，直接使用螺丝固定，安装方便简单，不影响窗户开关。

适用范围

广泛应用于酒店外墙、楼房、KTV、酒吧、别墅、花园庭院、窗台、阳台、过道、走廊、门框、背景墙、隧道等照明。

Product features

- Lamp body: high quality aluminum extrusion molding, thick shell with fast heat dissipation, anti-shock resistant, explosion-proof, durable, surface polyester powder spraying, antifading;
- Light source: imported integrated LED chip, low light, high lumen, soft light;
- Lens: super condenser lens, light transmittance as high as 95% above, anti-uv, light distribution, linear light, no foldover, according to optical window glass in everything in a glance, the explosion-proof processing, improve the lamp safety;
- Control light pollution, have monochrome, color color change;
- Protective: one-in-one moulding waterproof design, the inner to outer silica gel seal treatment, waterproof and dustproof, greatly improve the waterproof performance of the lamp body, more square, safer;
- Can be produced according to different window dimensions, large spot, small light spot;
- Installation mode: in the Ming style, the embedded (dark install) selection, direct use of screw fixation, easy to install, do not affect the window switch.

Scope of application

It is widely used in exterior wall, building, KTV, bar, villa, garden courtyard, windowsill, balcony, aisle, corridor, door frame, background wall, tunnel and other lighting.



绿色照明 节能环保 超长寿命 高显色性 温度极低



LED WINDOW LIGHT SERIES LED窗台灯系列

CTD-PQ01

详细参数/SPECIFICATION

光源/Light source:	著名品牌LED光源/famous brand LED light source
常规功率/Conventional power:	10W
灯具尺寸/Lamp size:	Ø100xH70mm
工作电压/Voltage:	DC24V/AC85-265V
灯具寿命/Lamp life:	≥30000H
LED光色/LED color:	R/Y/B/G/W/WW/RGB
色彩效果/Colour effect:	全彩、单色/full colour, monochrome
控制方式/Control mode:	国际标准DMX512/International standard DMX512
防护等级/Protection grade:	IP65
环境温度/Environment temperature:	-30°C~+50°C
发光角度/Light angle:	180°

线条尺寸图/Line size chart

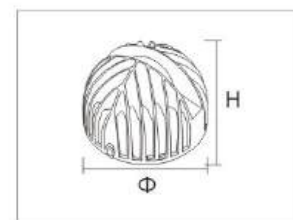

产品细节图/Product detail map



配光曲线图/Light distribution curve

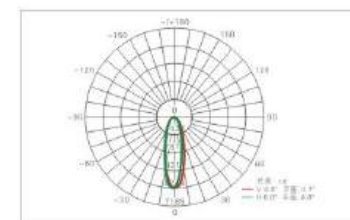

应用场景/Application scenario



表面处理：表面经阳极氧化、户外等级喷涂处理
Surface treatment: The surface is sprayed by anodic oxidation and outdoor grade

灯具材质：采用优质航空铝材成型
Lamp material: Use high quality aviation aluminum to form

应用场所：酒店外墙、楼房、KTV、酒吧、别墅、花园庭院、窗台、阳台、过道、走廊、门框、背景墙、隧道等照明
Application places: Hotel exterior wall, building, KTV, bar, villa, garden courtyard, windowsill, balcony, corridor, corridor, door frame, background wall, tunnel lighting

LED WINDOW LIGHT SERIES
LED窗台灯系列



CTD-PQ02

详细参数/SPECIFICATION

光源/Light source:	著名品牌LED光源/famous brand LED light source
常规功率/Conventional power:	10W
灯具尺寸/Lamp size:	Ø130xW52xH95mm
工作电压/Voltage:	DC24V/AC85-265V
灯具寿命/Lamp life:	≥30000H
LED光色/LED color:	R/Y/B/G/W/WW/RGB
色彩效果/Colour effect:	全彩、单色/full colour, monochrome
控制方式/Control mode:	国际标准DMX512/International standard DMX512
防护等级/Protection grade:	IP65
环境温度/Environment temperature:	-30℃~+50℃
发光角度/Light angle:	180°

线条尺寸图/Line size chart

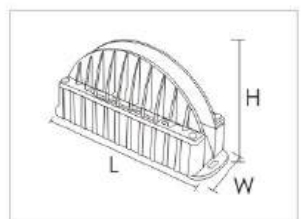

产品细节图/Product detail map



配光曲线图/Light distribution curve

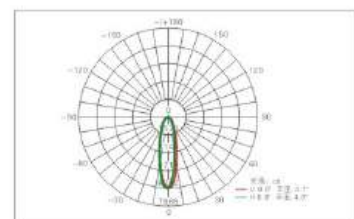

应用场景/Application scenario



表面处理: 表面经阳极氧化、户外等级喷涂处理
Surface treatment: The surface is sprayed by anodic oxidation and outdoor grade

灯具材质: 采用优质航空铝材成型
Lamp material: Use high quality aviation aluminum to form

应用场所: 酒店外墙、楼房、KTV、酒吧、别墅、花园庭院、窗台、阳台、过道、走廊、门框、背景墙、隧道等照明
Application places: Hotel exterior wall, building, KTV, bar, villa, garden courtyard, windowsill, balcony, corridor, corridor, door frame, background wall, tunnel lighting

LED WINDOW LIGHT SERIES
LED窗台灯系列



CTD-YY03

常规功率Conventional power:	12W
工作电压/Voltage:	DC24V/AC85-265V
LED光色/LED color:	R/Y/B/G/W/WW/RGB
防护等级/Protection grade:	IP65
发光角度/Light angle:	180°



CTD-YY04

常规功率Conventional power:	30W
工作电压/Voltage:	DC24V/AC85-265V
LED光色/LED color:	R/Y/B/G/W/WW/RGB
防护等级/Protection grade:	IP65
发光角度/Light angle:	180°



CTD-YY05

常规功率Conventional power:	6*3W
工作电压/Voltage:	DC24V/AC85-265V
LED光色/LED color:	R/Y/B/G/W/WW/RGB
防护等级/Protection grade:	IP65
发光角度/Light angle:	180°



CTD-YY06

常规功率Conventional power:	5*4W
工作电压/Voltage:	DC24V/AC85-265V
LED光色/LED color:	R/Y/B/G/W/WW/RGB
防护等级/Protection grade:	IP65
发光角度/Light angle:	180°

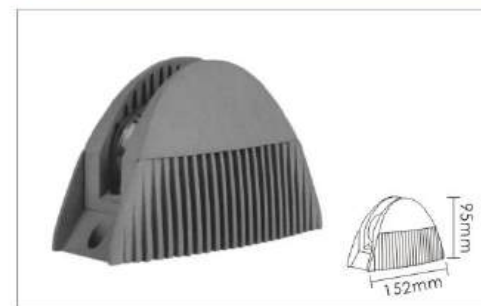

CTD-YY07

常规功率Conventional power:	16W
工作电压/Voltage:	DC24V/AC85-265V
LED光色/LED color:	R/Y/B/G/W/WW/RGB
防护等级/Protection grade:	IP65
发光角度/Light angle:	180°



CTD-YY08

常规功率Conventional power:	10W
工作电压/Voltage:	DC24V/AC85-265V
LED光色/LED color:	R/Y/B/G/W/WW/RGB
防护等级/Protection grade:	IP65
发光角度/Light angle:	180°



CTD-YY09

常规功率Conventional power:	5W
工作电压/Voltage:	DC24V/AC85-265V
LED光色/LED color:	R/Y/B/G/W/WW/RGB
防护等级/Protection grade:	IP65
发光角度/Light angle:	180°



CTD-YY10

常规功率Conventional power:	5W
工作电压/Voltage:	DC24V/AC85-265V
LED光色/LED color:	R/Y/B/G/W/WW/RGB
防护等级/Protection grade:	IP65
发光角度/Light angle:	180°



产品特点

- 导光板是利用光学级的亚克力、PC板材，然后用具有极高反射率且不吸光的高科技材料，在光学级的亚克力板材底面用UV网版印刷技术印上导光点；
- 导光板可以任意裁切成所需要的尺寸，也可以拼接使用；导光更均匀，均匀度可达90%甚至以上；
- 同等面积发光亮度情况下，具有很高的透光率，扩冲击能力强，发光效率高，高反射率，高转换率，高亮度，光线均匀柔和，功耗低；
- 使用寿命长，安全，节能，环保，耐用，可靠，美观，具有超薄、超亮、导光均匀、节能、环保、无暗区、耐用、不易黄化；
- 有效地利用了周围小点密集反射，中间大点的“较边”功能，完全没有暗纹和“黑洞”，而且可以制作特殊效果。

适用范围

广泛应用于楼宇、桥梁装饰照明等。

Product features

- Pieces of guide plate is to use optical acrylic, PC board, and then with high reflectivity and absorption of high-tech materials, in optical acrylic base with UV screen printing technology printed on the accurate;
- It can be cut into the required size, and can be used together. The guide light is even more uniform, and can reach 90% or more.
- With the same area of luminance, it has high transmittance, strong impact ability, high luminous efficiency, high reflectivity, high conversion rate, high brightness, uniform light and low power consumption.
- Long service life, safety, energy saving, environmental protection, durable, reliable, beautiful, with ultra-thin, super-bright, uniform light; energy saving, environmental protection, no dark area, durable, not easy to be yellow;
- It is effective to use the surroundings small point of dense reflection, the middle of the larger "the edge" function, completely without the dark print and "black hole". And you can make special effects.

Scope of application

It is widely used in building, bridge and decorative lighting.



DGB-001

详细参数/SPECIFICATION

光源/Light source:	著名品牌LED光源/famous brand LED light source
常规功率/Conventional power:	8-15W
灯具尺寸/Lamp size:	L1000xW35xH35mm
工作电压/Voltage:	DC24V
灯具寿命/Lamp life:	>30000H
LED光色/LED color:	R/Y/B/G/W/WW/RGB
色彩效果/Colour effect:	全彩、单色/full colour, monochrome
防护等级/Protection grade:	IP65
环境温度/Environment temperature:	-30℃~+50℃
发光角度/Light angle:	180°

线条尺寸图/Line size chart

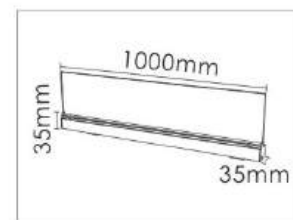

产品细节图/Product detail map



配光曲线图/Light distribution curve

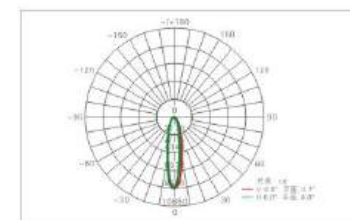

应用场景/Application scenario



表面处理: 喷涂户外高耐候环氧树脂粉末, 涂料/高耐候硬质阳极氧化
Surface treatment: Spray outdoor high resistance epoxy polyester powder, coating/high resistance to hard anodic oxidation

灯具材质: 采用优质航空铝材成型, 亚克力导光板
Lamp material: Adopt high quality aviation aluminum to form, Acrylic light guide

应用场所: 楼宇、桥梁装饰照明
Application places: Building and bridge decoration lighting



产品特点

- 灯体：压铸铝合金，表面光洁，无砂眼，无裂隙等；
- 透光罩：抗老化，防腐蚀，耐高温，透光均匀柔和；
- 紧固件：灯体外观采用不锈钢内六角螺丝固定；
- 密封圈：硅胶密封，防尘防水性能好，耐高温、抗老化。

适用范围

广泛应用于户外屋檐、棱角处投光，点状效果投射，弥补局部亮度不足。

Product features

- lamp body: die casting aluminum alloy, the surface is bright and clean, no blister, no crack, etc.;
- pieces of pervious to light cover: anti-aging, corrosion resistance, high temperature resistant, soft light evenly;
- pieces fasteners: the lamp body appearance stainless steel hex screws;
- seals: silica gel seal, dust-proof waterproof performance is good, high temperature resistant, anti-aging.

Scope of application

Widely used in outdoor, edges and corners of the roof light, projection point effect, make up for a lack of local brightness.



HWBD-LL01

详细参数/SPECIFICATION

光源/Light source:	著名品牌LED光源/famous brand LED light source
常规功率/Conventional power:	3x1W/3x2W/7x1W/7x2W
工作电压/Voltage:	AC85-265V
灯具寿命/Lamp life:	≥30000H
LED光色/LED color:	R/Y/B/G/W/WW/RGB
色彩效果/Colour effect:	全彩、单色/full colour, monochrome
灯具材质/Material:	铝材+钢化玻璃/AL+TG
防护等级/Protection grade:	IP65
环境温度/Environment temperature:	-30℃~+50℃
发光角度/Light angle:	8° /15° /30°

线条尺寸图/Line size chart

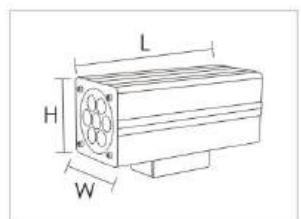

产品细节图/Product detail map

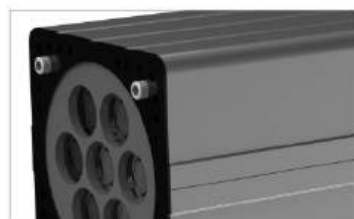

配光曲线图/Light distribution curve

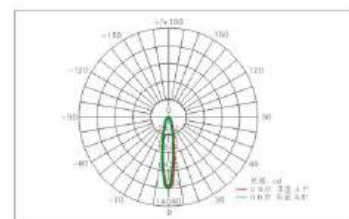

应用场景/Application scenario



3x1W/3x2W
L220xW75xH105mm



7x1W/7x2W
L242xW102xH132mm

应用场所: 户外屋檐、过道、棱角处投光
Application places: Outdoor eaves, aisles, Edges and corners in



HWBD-YY02

详细参数/SPECIFICATION

光源/Light source:	著名品牌LED光源/famous brand LED light source
常规功率/Conventional power:	5W/6W/12W
工作电压/Voltage:	AC85-265V
灯具寿命/Lamp life:	≥30000H
LED光色/LED color:	R/Y/B/G/W/WW/RGB
色彩效果/Colour effect:	全彩、单色/full colour, monochrome
灯具材质/Material:	铝材+钢化玻璃/AL+TG
防护等级/Protection grade:	IP65
环境温度/Environment temperature:	-30℃~+50℃
发光角度/Light angle:	15° /30° /45° /60°

线条尺寸图/Line size chart

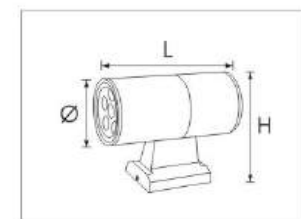

产品细节图/Product detail map



配光曲线图/Light distribution curve

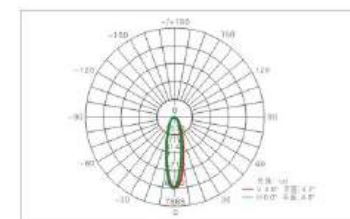

应用场景/Application scenario



3Wx2
Ø90xL260xH150mm



5W
Ø160xL160xH150mm



6W
Ø160xL190xH190mm



6Wx2
Ø160xL260xH190mm

应用场所: 户外屋檐、过道、棱角处投光
Application places: Outdoor eaves, aisles, Edges and corners in



HWBD-BT03

详细参数/SPECIFICATION

光源/Light source:	著名品牌LED光源/famous brand LED light source
常规功率/Conventional power:	12W/24W
工作电压/Voltage:	AC85-265V
灯具寿命/Lamp life:	≥30000H
LED光色/LED color:	R/Y/B/G/W/WW/RGB
色彩效果/Colour effect:	全彩、单色/full colour, monochrome
灯具材质/Material:	铝材+钢化玻璃/AL+TG
防护等级/Protection grade:	IP65
环境温度/Environment temperature:	-30℃~+50℃
发光角度/Light angle:	15° /30° /45° /60°

线条尺寸图/Line size chart

产品细节图/Product detail map

配光曲线图/Light distribution curve

应用场景/Application scenario

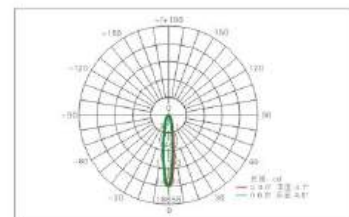
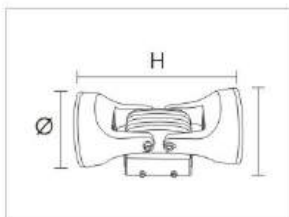

12W
Ø95xH209mm



24W
Ø130xH267mm

应用场所: 户外屋檐、过道、棱角处投光
Application places: Outdoor eaves, aisles, Edges and corners in



HWBD-004

详细参数/SPECIFICATION

光源/Light source:	著名品牌LED光源/famous brand LED light source
常规功率/Conventional power:	3W/3Wx2
工作电压/Voltage:	AC85-265V
灯具寿命/Lamp life:	≥30000H
LED光色/LED color:	R/Y/B/G/W/WW/RGB
色彩效果/Colour effect:	全彩、单色/full colour, monochrome
灯具材质/Material:	铝材+钢化玻璃/AL+TG
防护等级/Protection grade:	IP65
环境温度/Environment temperature:	-30℃~+50℃
发光角度/Light angle:	15° /30° /45° /60°

线条尺寸图/Line size chart

产品细节图/Product detail map

配光曲线图/Light distribution curve

应用场景/Application scenario

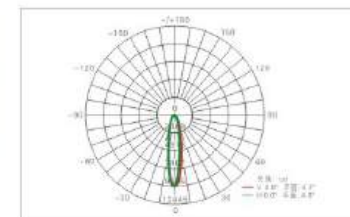
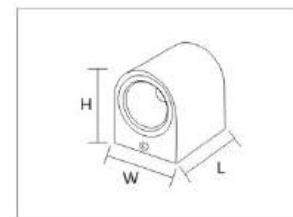

3W
L80xW68xH80mm



3Wx2
L150xW68xH80mm



3W
L80xW68xH80mm



3Wx2
L150xW68xH80mm

应用场所: 户外屋檐、过道、棱角处投光
Application places: Outdoor eaves, aisles, Edges and corners in

LED OUTDOOR WALL LAMP SERIES
LED户外壁灯系列



HWBD-YY05

详细参数/SPECIFICATION

光源/Light source:	著名品牌LED光源/famous brand LED light source
常规功率/Conventional power:	9*2W/12*2W/18*2W/24*2W
工作电压/Voltage:	AC85-265V
灯具寿命/Lamp life:	>30000H
LED光色/LED color:	R/Y/B/G/W/WW/RGB
色彩效果/Colour effect:	全彩、单色/full colour, monochrome
灯具材质/Material:	铝材+钢化玻璃/AL+TG
防护等级/Protection grade:	IP65
环境温度/Environment temperature:	-30℃~+50℃
发光角度/Light angle:	15°/30°/45°/60°

线条尺寸图/Line size chart



产品细节图/Product detail map



配光曲线图/Light distribution curve

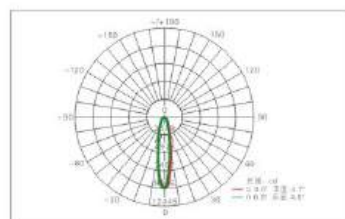

应用场景/Application scenario



应用场所: 户外屋檐、过道、棱角处投光
Application places: Outdoor eaves, aisles, Edges and corners in

LED OUTDOOR WALL LAMP SERIES
LED户外壁灯系列



HWBD-006

详细参数/SPECIFICATION

光源/Light source:	著名品牌LED光源
常规功率/Conventional power:	20W
工作电压/Voltage:	AC85-265V
灯具寿命/Lamp life:	>30000H
LED光色/LED color:	R/Y/B/G/W/WW/RGB
色彩效果/Colour effect:	全彩、单色/full colour, monochrome
防护等级/Protection grade:	IP65
环境温度/Environment temperature:	-30℃~+50℃
灯具材质/Lamp material:	铝材+钢化玻璃/AL+TG

线条尺寸图/Line size chart

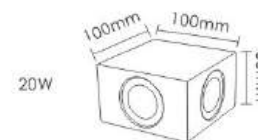

HWBD-HY07

详细参数/SPECIFICATION

光源/Light source:	著名品牌LED光源
工作电压/Voltage:	AC85-265V
灯具寿命/Lamp life:	>30000H
LED光色/LED color:	R/Y/B/G/W/WW/RGB
色彩效果/Colour effect:	全彩、单色/full colour, monochrome
防护等级/Protection grade:	IP65
环境温度/Environment temperature:	-30℃~+50℃
灯具材质/Lamp material:	铝材/AL
发光角度/Beam angle:	15°/30°/45°/60°

线条尺寸图/Line size chart

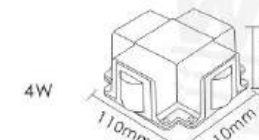

HWBD-YY08

详细参数/SPECIFICATION

光源/Light source:	著名品牌LED光源
常规功率/Conventional power:	9W*2
工作电压/Voltage:	AC85-265V
灯具寿命/Lamp life:	>30000H
LED光色/LED color:	R/Y/B/G/W/WW/RGB
色彩效果/Colour effect:	全彩、单色/full colour, monochrome
防护等级/Protection grade:	IP65
环境温度/Environment temperature:	-30℃~+50℃
灯具材质/Lamp material:	铝材+钢化玻璃/AL+TG

线条尺寸图/Line size chart

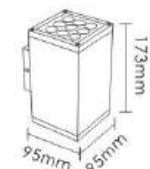

HWBD-LL09

详细参数/SPECIFICATION

光源/Light source:	著名品牌LED光源
常规功率/Conventional power:	9W/12W/15W/18W/24W*2
工作电压/Voltage:	AC85-265V
灯具寿命/Lamp life:	>30000H
LED光色/LED color:	R/Y/B/G/W/WW/RGB
色彩效果/Colour effect:	全彩、单色/full colour, monochrome
防护等级/Protection grade:	IP65
环境温度/Environment temperature:	-30℃~+50℃
灯具材质/Lamp material:	铝材+钢化玻璃/AL+TG

线条尺寸图/Line size chart

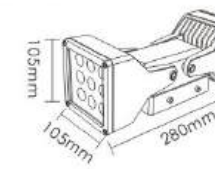



WOYLD
沃蓝达照明



WOYLD
沃蓝达照明

产品特点

- 采用超高亮度SMD, 节能环保, 灯体柔软可随意弯曲, 任意固定在凹凸物体表面, 3个LED一回路, 可根据实际情况进行裁剪;
- DC12V低压供电, 更安全稳定;
- 安装简便: 使用固定卡夹或3m胶纸固定;
- 光衰小、使用寿命长;

适用范围

广泛应用于各种室内、室外装修、公园小区美化、商场橱窗、渔池、游泳馆、KTV包间暗槽的装修、酒店、楼体的轮廓等LED亮化工程。

Product features

- With super high brightness SMD, energy saving and environmental protection, the lamp body is soft and can be bent freely, for any fixed in the concave and convex surfaces, 3 LED loop, can be carried out according to the actual situation of cutting;
- DC12V low-voltage power supply, more security and stability;
- Simple installation: the use of fixed clip or 3M adhesive tape fixed;
- Light, long service life.

Scope of application

Product use: widely used in a variety of indoor, outdoor decoration, Park District Landscaping, shopping malls Showcase, fish pond, swimming pool, KTV rooms dark groove decoration, hotel, building the contour of the body such as LED lighting project.

WOYLD
沃蓝达照明

WOYLD
沃蓝达照明

LED SOFT LIGHT STRIP SERIES
LED软灯带系列



2835-12V



套管型(PC) Waterproof Tube(PC)
裸露型(NK) Naked(NK)
灌胶防水型(PC+PU) Irrigating Glue(PC+PU)
滴胶防水型(PU) Glue(PU)
滴胶套管型(PU+PC) Solid Fill Glue and Waterproof Tube(PR+PC)

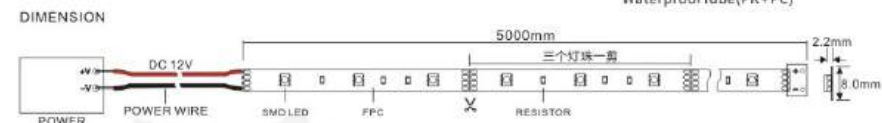

5050-12V



套管型(PC) Waterproof Tube(PC)
裸露型(NK) Naked(NK)
灌胶防水型(PC+PU) Irrigating Glue(PC+PU)
滴胶防水型(PU) Glue(PU)
滴胶套管型(PU+PC) Solid Fill Glue and Waterproof Tube(PR+PC)

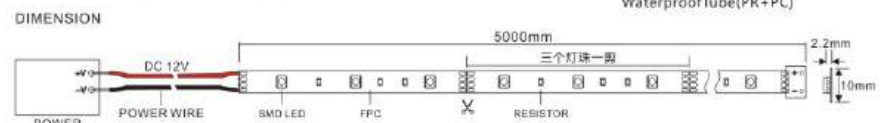

详细参数/SPECIFICATION

型号 Model	工作电压 Working voltage	LED颜色 LED color	功率 Power	灯珠数量 Lamp beads quantity	电流 MA	灯具尺寸 Lamp size	发光角度 Shine angle
RDD-2835	DC12V	R●/Y●/B●/G●/W○/WW●/RGB●	≤7W/9.5W/m	60/120	20	5m	160°
RDD-5050	DC12V	R●/Y●/B●/G●/W○/WW●/RGB●	≤12W/m	60	60	5m	160°

LED SOFT LIGHT STRIP SERIES
LED软灯带系列



2835-220V

产品特点

- 与DC12V灯条和普通彩虹管相对比, 高压220V灯条有以下优点:
- 安装方便, 不必使用电源开关, 直接220V供电;
- 可串联长达50-100M, 解决低压串联长度限制问题;
- 采用全铜芯线, 透明PVC胶体封装;
- 与普通彩虹管相比, 220V灯条体积小, 亮度高;
- 与普通彩虹管相比, 220V灯条采用全自动SMD贴片设备, 产品质量更稳定。

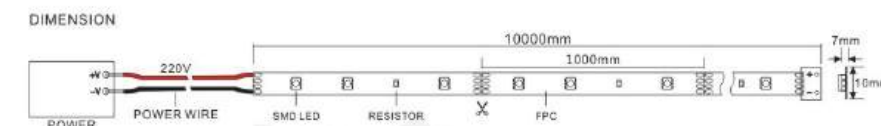

5050-220V

Product features

- And DC12V lamp and ordinary rainbow tube phase contrast, high-pressure 220V lamp has the following advantages:
- convenient installation, without the use of a power switch, a direct 220V power supply;
- may be connected in series for 50-100M, solve the low voltage series length limitation;
- the copper wire, transparent PVC colloid sealing glue;
- and the ordinary rainbow tube, 220V lamp has the advantages of small volume, high brightness;
- and the ordinary rainbow tube, 220V lamp with automatic SMD placement equipment, product quality more stable.

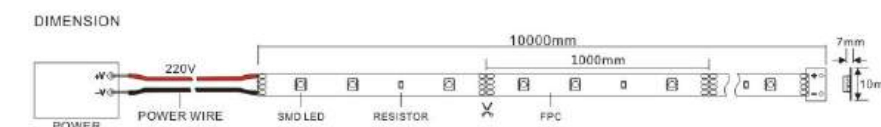

详细参数/SPECIFICATION

型号 Model	工作电压 Working voltage	LED颜色 LED color	功率 Power	灯珠数量 Lamp beads quantity	电流 MA	灯具尺寸 Lamp size	发光角度 Shine angle
RDD-2835	220V	R●/Y●/B●/G●/W○/WW●/RGB●	≤6W/8W/8.5W/9.5W/12W/m	60/75/120/180	20	100m	160°
RDD-5050	220V	R●/Y●/B●/G●/W○/WW●/RGB●	≤12W/m	60	60	100m	160°

产品特点

LED点光源是一种新型的节能环保装饰灯,采用超高亮度的进口芯片为光源,内置微电脑芯片,可任意编程控制,多个同步变化、超低功率、超长寿命,单色变化也可实现同步七彩渐变、跳变、扫描、流水等全彩变化效果及多个点光源组成点阵屏,变化出各种图画、文字和动画效果,是线性光源及泛光照明中的一个补充,外形美观大方可满足楼体等装饰物的点线面的设计要求,防水性能好控制方便,安装更便利。

适用范围

广泛应用于:建筑物、游乐园、大型广告牌、幕墙、广场街道、舞台酒吧等场所。

Product features

LED point light source is a new kind of energy conservation and environmental protection decorative light, adopts high brightness imported chip as the light source, the built-in microcomputer chip, can be arbitrary programming control, multiple synchronous, ultra low power, long life, monochrome changes also can realize synchronous colorful gradient, jump and steps of scanning, full color change effect and multiple point source of lattice screen, change out of all kinds of pictures, text and animation effects, is the linear light source and a supplement of the flood lighting, beautiful appearance can satisfy the building decoration, such as point, line below the design requirements, good waterproof performance control convenient, more convenient to install.

Scope of application

Widely used in, buildings, parks, large billboards, curtain wall, square, street, stage bars and other places.



DGY-001

详细参数/SPECIFICATION

光源/Light source:	著名品牌LED光源/famous brand LED light source
常规功率/Conventional power:	1-3W/9-12W
工作电压/Voltage:	DC24V
灯具寿命/Lamp life:	>30000H
LED光色/LED color:	R/Y/B/G/W/WW/RGB
色彩效果/Colour effect:	全彩、单色/full colour, monochrome
控制方式/Control mode:	国际标准DMX512/International standard DMX512
防护等级/Protection grade:	IP65
环境温度/Environment temperature:	-30℃~+50℃
灯体材质/Material:	压铸铝/AL
发光角度/Light angle:	120°

线条尺寸图/Line size chart

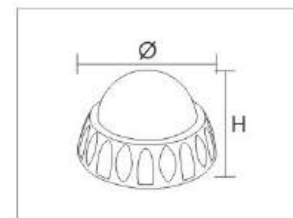

产品细节图/Product detail map



配光曲线图/Light distribution curve

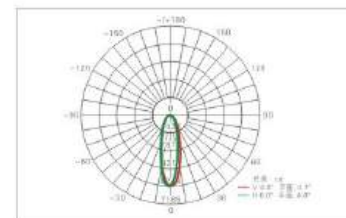

应用场景/Application scenario





DGY-002

详细参数/SPECIFICATION

光源/Light source:	著名品牌LED光源/famous brand LED light source
常规功率/Conventional power:	1-3W
工作电压/Voltage:	DC24V
灯具寿命/Lamp life:	≥30000H
LED光色/LED color:	R/Y/B/G/W/WW/RGB
色彩效果/Colour effect:	全彩、单色/full colour, monochrome
控制方式/Control mode:	国际标准DMX512/International standard DMX512
防护等级/Protection grade:	IP65
环境温度/Environment temperature:	-30℃~+50℃
灯体材质/Material:	压铸铝/AL
发光角度/Light angle:	120°

线条尺寸图/Line size chart | 产品细节图/Product detail map | 配光曲线图/Light distribution curve | 应用场景/Application scenario



应用场所: 楼房、桥梁等建筑轮廓勾勒、游乐园、大型广告牌、宾馆、KTV、酒店、幕墙、广场街道、酒吧
Application places: Buildings, Bridges and other architectural outline, amusement park, large billboards, hotels, KTV, hotels, curtain walls, square streets, bars

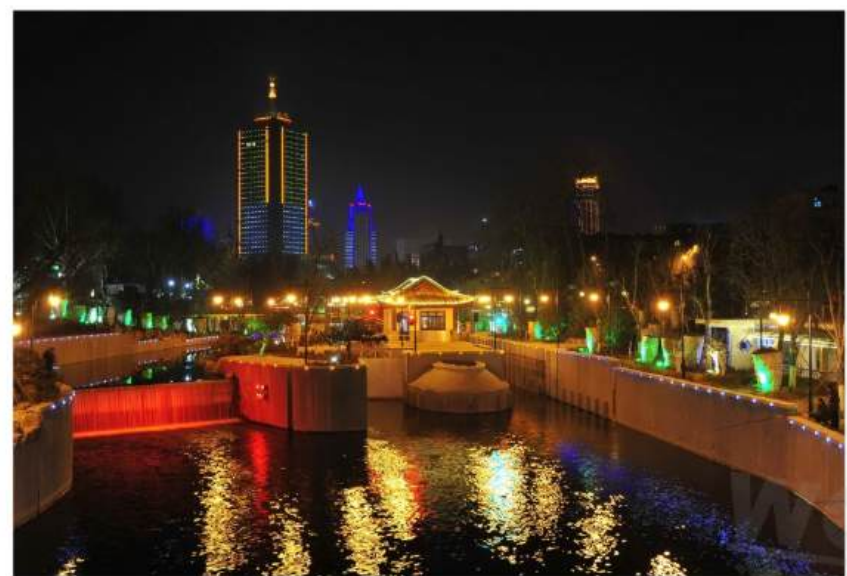

DGY-003

详细参数/SPECIFICATION

光源/Light source:	著名品牌LED光源/famous brand LED light source
常规功率/Conventional power:	5-7W
工作电压/Voltage:	DC24V
灯具寿命/Lamp life:	≥30000H
LED光色/LED color:	R/Y/B/G/W/WW/RGB
色彩效果/Colour effect:	全彩、单色/full colour, monochrome
控制方式/Control mode:	国际标准DMX512/International standard DMX512
防护等级/Protection grade:	IP65
环境温度/Environment temperature:	-30℃~+50℃
灯体材质/Material:	压铸铝/AL
发光角度/Light angle:	120°

线条尺寸图/Line size chart | 产品细节图/Product detail map | 配光曲线图/Light distribution curve | 应用场景/Application scenario



应用场所: 楼房、桥梁等建筑轮廓勾勒、游乐园、大型广告牌、宾馆、KTV、酒店、幕墙、广场街道、酒吧
Application places: Buildings, Bridges and other architectural outline, amusement park, large billboards, hotels, KTV, hotels, curtain walls, square streets, bars





DGY-004

详细参数/SPECIFICATION

光源/Light source:	著名品牌LED光源/famous brand LED light source
常规功率/Conventional power:	6W/9W
工作电压/Voltage:	DC24V
灯具寿命/Lamp life:	≥30000H
LED光色/LED color:	R/Y/B/G/W/WW/RGB
色彩效果/Colour effect:	全彩、单色/full colour, monochrome
控制方式/Control mode:	国际标准DMX512/International standard DMX512
防护等级/Protection grade:	IP65
环境温度/Environment temperature:	-30℃~+50℃
灯体材质/Material:	压铸铝/AL
发光角度/Light angle:	120°

线条尺寸图/Line size chart

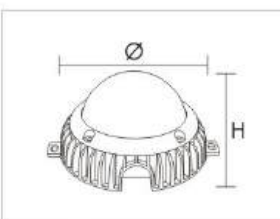

产品细节图/Product detail map



配光曲线图/Light distribution curve

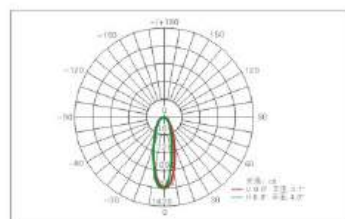

应用场景/Application scenario



DGY-005



DGY-006



DGY-007



详细参数/SPECIFICATION

光源/Light source:	著名品牌LED光源/famous brand LED light source
常规功率/Conventional power:	6W
工作电压/Voltage:	DC24V
灯具寿命/Lamp life:	≥30000H
LED光色/LED color:	R/Y/B/G/W/WW/RGB
色彩效果/Colour effect:	全彩、单色/full colour, monochrome
防护等级/Protection grade:	IP65
环境温度/Environment temperature:	-30℃~+50℃
发光角度/Light angle:	120°

详细参数/SPECIFICATION

光源/Light source:	著名品牌LED光源/famous brand LED light source
常规功率/Conventional power:	9W
工作电压/Voltage:	DC24V
灯具寿命/Lamp life:	≥30000H
LED光色/LED color:	R/Y/B/G/W/WW/RGB
色彩效果/Colour effect:	全彩、单色/full colour, monochrome
防护等级/Protection grade:	IP65
环境温度/Environment temperature:	-30℃~+50℃
发光角度/Light angle:	120°

详细参数/SPECIFICATION

光源/Light source:	著名品牌LED光源/famous brand LED light source
常规功率/Conventional power:	5W
工作电压/Voltage:	DC24V
灯具寿命/Lamp life:	≥30000H
LED光色/LED color:	R/Y/B/G/W/WW/RGB
色彩效果/Colour effect:	全彩、单色/full colour, monochrome
防护等级/Protection grade:	IP65
环境温度/Environment temperature:	-30℃~+50℃
发光角度/Light angle:	120°

LED POINT LIGHT SERIES
LED点光源系列



DGY-008



7-9W L120xW120xH48mm

详细参数/SPECIFICATION

光源Light source:	著名品牌LED光源/famous brand LED light source
常规功率Conventional power:	7-9W
工作电压/Voltage:	DC24V
灯具寿命/Lamp life:	>30000H
LED光色/LED color:	R/Y/B/G/W/WW/RGB
色彩效果/Colour effect:	全彩、单色/full colour, monochrome
防护等级/Protection grade:	IP65
环境温度/Environment temperature:	-30°C~+50°C
发光角度/Light angle:	120°



DGY-009



3-5W Ø85xH67mm

详细参数/SPECIFICATION

光源Light source:	著名品牌LED光源/famous brand LED light source
常规功率Conventional power:	3-5W
工作电压/Voltage:	DC24V
灯具寿命/Lamp life:	>30000H
LED光色/LED color:	R/Y/B/G/W/WW/RGB
色彩效果/Colour effect:	全彩、单色/full colour, monochrome
防护等级/Protection grade:	IP65
环境温度/Environment temperature:	-30°C~+50°C
发光角度/Light angle:	120°



DGY-010



7-9W Ø86xH40mm

详细参数/SPECIFICATION

光源Light source:	著名品牌LED光源/famous brand LED light source
常规功率Conventional power:	7-9W
工作电压/Voltage:	DC24V
灯具寿命/Lamp life:	>30000H
LED光色/LED color:	R/Y/B/G/W/WW/RGB
色彩效果/Colour effect:	全彩、单色/full colour, monochrome
防护等级/Protection grade:	IP65
环境温度/Environment temperature:	-30°C~+50°C
发光角度/Light angle:	120°



LED POINT LIGHT SERIES
LED点光源系列



DGY-011



9W L100*W100*H110mm

详细参数/SPECIFICATION

光源Light source:	著名品牌LED光源/famous brand LED light source
常规功率Conventional power:	9W/12W
工作电压/Voltage:	DC24V
灯具寿命/Lamp life:	>30000H
LED光色/LED color:	R/Y/B/G/W/WW/RGB
色彩效果/Colour effect:	全彩、单色/full colour, monochrome
防护等级/Protection grade:	IP65
环境温度/Environment temperature:	-30°C~+50°C
发光角度/Light angle:	120°



DGY-012



3W Ø60*H45mm

详细参数/SPECIFICATION

光源Light source:	著名品牌LED光源/famous brand LED light source
常规功率Conventional power:	3W
工作电压/Voltage:	DC24V
灯具寿命/Lamp life:	>30000H
LED光色/LED color:	R/Y/B/G/W/WW/RGB
色彩效果/Colour effect:	全彩、单色/full colour, monochrome
防护等级/Protection grade:	IP65
环境温度/Environment temperature:	-30°C~+50°C
发光角度/Light angle:	120°



DGY-013



6W Ø120*H70mm

详细参数/SPECIFICATION

光源Light source:	著名品牌LED光源/famous brand LED light source
常规功率Conventional power:	6W/9W
工作电压/Voltage:	DC24V
灯具寿命/Lamp life:	>30000H
LED光色/LED color:	R/Y/B/G/W/WW/RGB
色彩效果/Colour effect:	全彩、单色/full colour, monochrome
防护等级/Protection grade:	IP65
环境温度/Environment temperature:	-30°C~+50°C
发光角度/Light angle:	120°

LED POINT LIGHT SERIES
LED点光源系列



DGY-014



DGY-015



DGY-016



详细参数/SPECIFICATION

光源Light source:	著名品牌LED光源/famous brand LED light source
常规功率Conventional power:	3-5W/5-7W
工作电压/Voltage:	DC24V
灯具寿命/Lamp life:	>30000H
LED光色/LED color:	R/Y/B/G/W/WW/RGB
色彩效果/Colour effect:	全彩、单色/full colour, monochrome
防护等级/Protection grade:	IP65
环境温度/Environment temperature:	-30℃~+50℃
发光角度/Light angle:	120°

详细参数/SPECIFICATION

光源Light source:	著名品牌LED光源/famous brand LED light source
常规功率Conventional power:	9W/15W
工作电压/Voltage:	DC24V
灯具寿命/Lamp life:	>30000H
LED光色/LED color:	R/Y/B/G/W/WW/RGB
色彩效果/Colour effect:	全彩、单色/full colour, monochrome
防护等级/Protection grade:	IP65
环境温度/Environment temperature:	-30℃~+50℃
发光角度/Light angle:	120°

详细参数/SPECIFICATION

光源Light source:	著名品牌LED光源/famous brand LED light source
常规功率Conventional power:	3-5W
工作电压/Voltage:	DC24V
灯具寿命/Lamp life:	>30000H
LED光色/LED color:	R/Y/B/G/W/WW/RGB
色彩效果/Colour effect:	全彩、单色/full colour, monochrome
防护等级/Protection grade:	IP65
环境温度/Environment temperature:	-30℃~+50℃
发光角度/Light angle:	120°



LED POINT LIGHT SERIES
LED点光源系列



DGY-017

常规功率Conventional power:	5-7W
工作电压/Voltage:	DC24V
LED光色/LED color:	R/Y/B/G/W/WW/RGB
防护等级/Protection grade:	IP65
发光角度/Light angle:	120°



DGY-018

常规功率Conventional power:	5W
工作电压/Voltage:	DC24V
LED光色/LED color:	R/Y/B/G/W/WW/RGB
防护等级/Protection grade:	IP65
发光角度/Light angle:	120°



DGY-019

常规功率Conventional power:	9-12W
工作电压/Voltage:	DC24V
LED光色/LED color:	R/Y/B/G/W/WW/RGB
防护等级/Protection grade:	IP65
发光角度/Light angle:	120°



DGY-020

常规功率Conventional power:	5-7W
工作电压/Voltage:	DC24V
LED光色/LED color:	R/Y/B/G/W/WW/RGB
防护等级/Protection grade:	IP65
发光角度/Light angle:	120°



DGY-021

常规功率Conventional power:	5-7W
工作电压/Voltage:	DC24V
LED光色/LED color:	R/Y/B/G/W/WW/RGB
防护等级/Protection grade:	IP65
发光角度/Light angle:	120°



DGY-022

常规功率Conventional power:	3-5W
工作电压/Voltage:	DC24V
LED光色/LED color:	R/Y/B/G/W/WW/RGB
防护等级/Protection grade:	IP65
发光角度/Light angle:	120°



DGY-023

常规功率Conventional power:	3-5W
工作电压/Voltage:	DC24V
LED光色/LED color:	R/Y/B/G/W/WW/RGB
防护等级/Protection grade:	IP65
发光角度/Light angle:	120°



DGY-024

常规功率Conventional power:	1-3W
工作电压/Voltage:	DC24V
LED光色/LED color:	R/Y/B/G/W/WW/RGB
防护等级/Protection grade:	IP65
发光角度/Light angle:	120°

LED POINT LIGHT SERIES
LED点光源系列



DGY-025

常规功率Conventional power:	3-5W
工作电压/Voltage:	DC24V
LED光色/LED color:	R/Y/B/G/W/WW/RGB
防护等级/Protection grade:	IP65
发光角度/Light angle:	120°



DGY-026

常规功率Conventional power:	5W
工作电压/Voltage:	DC24V
LED光色/LED color:	R/Y/B/G/W/WW/RGB
防护等级/Protection grade:	IP65
发光角度/Light angle:	120°



DGY-027

常规功率Conventional power:	3-5W
工作电压/Voltage:	DC24V
LED光色/LED color:	R/Y/B/G/W/WW/RGB
防护等级/Protection grade:	IP65
发光角度/Light angle:	120°



DGY-028

常规功率Conventional power:	5-7W
工作电压/Voltage:	DC24V
LED光色/LED color:	R/Y/B/G/W/WW/RGB
防护等级/Protection grade:	IP65
发光角度/Light angle:	120°



DGY-029

常规功率Conventional power:	1-3W
工作电压/Voltage:	DC24V
LED光色/LED color:	R/Y/B/G/W/WW/RGB
防护等级/Protection grade:	IP65
发光角度/Light angle:	120°



DGY-030

常规功率Conventional power:	3-5W
工作电压/Voltage:	DC24V
LED光色/LED color:	R/Y/B/G/W/WW/RGB
防护等级/Protection grade:	IP65
发光角度/Light angle:	120°



DGY-031

常规功率Conventional power:	5-9W
工作电压/Voltage:	DC24V
LED光色/LED color:	R/Y/B/G/W/WW/RGB
防护等级/Protection grade:	IP65
发光角度/Light angle:	120°



DGY-032

常规功率Conventional power:	6-9W
工作电压/Voltage:	DC24V
LED光色/LED color:	R/Y/B/G/W/WW/RGB
防护等级/Protection grade:	IP65
发光角度/Light angle:	120°

LED POINT LIGHT SERIES
LED点光源系列



LED跑马灯
1.灯带结构，安装便捷，外形美观；
2.灯壳、灯带一体化结构，防水IP67；
3.采用系列显示屏专用光源，寿命长、亮度高、配色丰富，阳光直射下也可显示出丰富色彩；
4.单线信号传输，稳定、抗干扰性强；
5.线材与底壳有透明和黑色可选，可实现隐形安装；
6.每米6-12点可选，按需定制；
7.每条灯带可任意制作长度、可弯曲、可折叠、可随意安装；
8.可做单色和全彩外控，可联机控制或脱机控制，适用于制作异形屏、广告光源、楼宇轮廓、酒店夜场等灯光场所。



LED跑马灯
用途：使用灵活，相比传统全彩屏可以自由设计灯条安装密度，可以自由控制整屏成本，安装简单，可随意弯曲，不影响建筑广告屏外观，特别适合超大型全彩屏，门头广告屏，楼顶广告屏，喷绘全彩屏等。
Uses: flexible use, compared to the traditional full color screen can be freely designed to install the light bar density, can freely control the cost of the whole screen, easy to install, can be bent freely, does not affect the appearance of the building advertising screen, especially suitable for super large full color screen, door advertising screen, the roof advertising screen, inkjet full color screen and so on.



LED跑马灯
品名：LED跑马灯
规格：30x30mm(小)/50x50mm(大)
点密度：每米4点/每米6点/每米8点
单条长度：1-20米之间任意长度
材质：底壳ABS,面罩PC
光源数量和功率：20珠/点/1.5W
10珠/点/0.7W(大)
10珠/点/0.7W
4珠/点/0.3W(小)
发光颜色：全彩外控
防护等级：IP67
电压：20珠/点DC24V 10珠/点DC12V 4珠/点DC5V

Name: LED Marquee
Specifications: 30x30mm[small]/50x50mm[large]
Dot density: 4 metres per bit per M 6/8 metres per point
A single length: 1-20 meters between arbitrary length
Material: Pan ABS PC,mask
Quantity of light source and power: 20 bead/point/1.5W
10 bead/point/0.7W(large)
10 bead/point/1.7W
4 bead/point/0.3W(small)
Luminous color: color control
Protection grade: Ip67
Voltage: 20 bead/DC24V 10 bead/DC12V 4 bead/DC5V



LED METEOR TUBE SERIES
LED流星管系列

产品特点

- 灯体采用进口乳白、透明PC材料，透光性好，同时耐寒、抗红、紫外线、抗老化、不易破碎、防水性能好；
- 采用超高亮LED作为光源，通过微芯片控制，使流星划过的一瞬间就在你眼前呈现，可实现渐变、色彩闪烁、渐变交替、追逐、扫描等流动颜色变化；整个光效瞬间闪过，黑夜里就像天空划过的流星一样，让你的美好愿望得以实现；
- 防水、防尘、防腐蚀、不受时间和空间限制；
- 外带驱动，低压供电
- 使用寿命长，可达80,000小时，安装简便，客户无后顾之忧。

适用范围

广泛应用于城市夜景亮化建筑装饰、街道两旁、公园、园林广场、步行街、庭院、楼桥、河岸边树木上、屋檐下及墙壁表面装饰、城堡、度假村、宾馆大厅、旅游景点、绿化带多用于户外演出、夜总会、歌舞厅、酒吧、迪士高酒吧、舞台顶渲染气氛、游乐场、社区夜景装饰、酒店、商场、娱乐场所周边环境夜景装饰、家居装饰等

Product features

- lamp body adopts imported milky white, transparent PC material, good pervious to light, at the same time, hardy, red, uv resistance, anti-aging, invulnerability to breakage and waterproof properties is good;
- pieces using ultra bright LED as light source, controlled by microchip, the meteor across the moment it's in front of you, which can realize the gradient, color flashing, Alternating gradient, chase, scan flow such as color change; Just flashes the light efficiency, like the meteor across the sky in the night, let your good wishes be realized;
- pieces of waterproof, dustproof, anti-corrosion, not restricted by time and space;
- pieces to go drive, low voltage power supply
- pieces service life is long, up to 80000 hours, convenient installation, customers worry-free.

Scope of application

Widely used in urban nightscape lighting building decoration, streets, parks, squares, riverbank, roof and wall surface decoration on the trees, castle, holiday village, Tourist attractions, green belts, the other is used for more outdoor performances, nightclubs, smallpox Dishi Gao bar, night at top stage apply colours to a drawing atmosphere, playgrounds, community decoration, hotels, shopping malls, Night at entertainment places surrounding environment decoration, home decoration, etc



电源接线
一流的制作工艺确保线路安全
外观整洁、坚韧、不易断裂

防水堵头
采用优质亚克力防水型
堵头，可在户外使用

高流明进口贴片灯珠



LED METEOR TUBE SERIES
LED流星管系列

详细参数/SPECIFICATION

品名 Commodity	电压 Voltage	功率 Power	灯珠类型 Lamp Bead Type	灯珠数量 Lamp Bead QTY	尺寸 Size	颜色 Color	材质 Material
LXG-001	DC24V	3.6W	SMD2835	36PCS	Φ12x300mm	R/Y/B/G/W/WW/RGB	PC管
LXG-002	DC24V	6W	SMD2835	60PCS	Φ12x500mm	R/Y/B/G/W/WW/RGB	PC管
LXG-003	DC24V	7.2W	SMD2835	72PCS	Φ12x800mm	R/Y/B/G/W/WW/RGB	PC管

LED CHINESE KNOT SERIES LED中国结系列

产品特点

中国结象征着合家团圆、事业兴旺、红红火火，象征幸福、光明、活力、团结与富贵。每逢重大节日、良辰吉庆之时，许多城镇的街道、商店、公园，甚至一些大型建筑物和私家宅院的门口都会挂起红红的中国结。LED中国结，造型优美，色彩艳丽，到了夜晚，一盏盏中国结点亮，红光四射，显得隆重热闹，喜气洋洋……

Product features

China as a symbol of family reunion, prosperity, and prosperous, a symbol of happiness, bright, vigor, unity and riches and honour, every major holiday, may JiQingzhi, many towns in the streets, shops, parks, even some large buildings and private house can hang at the door of the red Chinese knot. LED Chinese knot, beautiful modeling, colour is gorgeous, at night, station Chinese knot light, red light, appear lively, grand beaming...

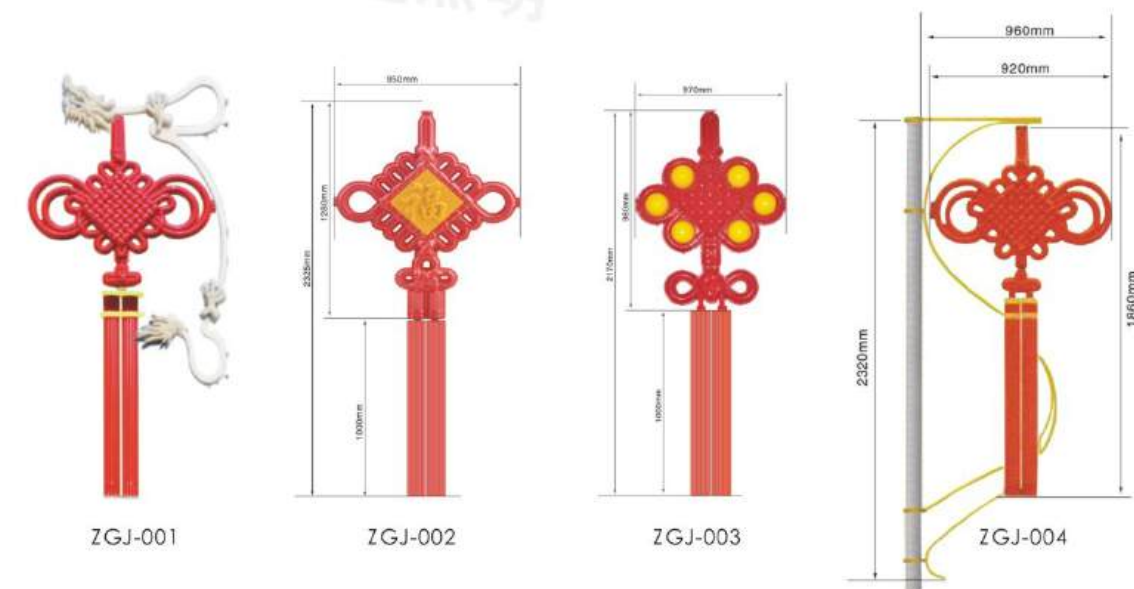

ZGJ-001/002/003

灯具功率 Lamp power	1-20W
灯具材质 Lamp material	钢+PET+发光大理石支架
防护等级 Protection grade	IP65
工作电压 Working voltage	24V/AC110-240V
LED颜色 LED color	W/WW
环境温度 Ambient temperature	-30℃~+50℃

ZGJ-004

灯具功率 Lamp power	32W
灯具材质 Lamp material	钢+PET+发光大理石支架
防护等级 Protection grade	IP65
工作电压 Working voltage	24V/AC110-240V
LED颜色 LED color	W/WW
环境温度 Ambient temperature	-30℃~+50℃



LED LANTERNS SERIES LED灯笼系列

产品特点

中国灯笼象征着合家团圆、事业兴旺、红红火火，象征幸福、光明、活力、团结与富贵。每逢重大节日、良辰吉庆之时，许多城镇的街道、商店、公园，甚至一些大型建筑物和私家宅院的门口都会挂起红红的灯笼。LED灯笼，造型优美，色彩艳丽，到了夜晚，一盏盏灯笼点亮，红光四射，显得隆重热闹，喜气洋洋……

Product features

Chinese lanterns as a symbol of family reunion, prosperity, and prosperous, a symbol of happiness, bright, vigor, unity and riches and honour, every major holiday, may JiQingzhi, many towns in the streets, shops, parks, and even some large buildings and the entrance of the gate of the private house will hang up red lanterns. LED lanterns, beautiful modeling, colour is gorgeous, at night, station lantern lights, red, appear lively, grand beaming...



DL-001/002/003

灯具功率 Lamp power	1-20W
灯具材质 Lamp material	PC
防护等级 Protection grade	IP65
工作电压 Working voltage	24V/AC110-240V
LED颜色 LED color	W/WW
环境温度 Ambient temperature	-30℃~+50℃

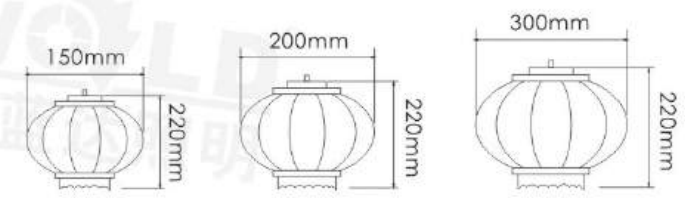

LED SOLAR STREET LIGHT SERIES
LED太阳能路灯系列



特有的数字LED驱动技术，太阳能系统80%的节电控制技术，LED灯珠直接形成4:1长方形光斑技术（不外加透镜），蓄电纳米防水技术（透气防水），人性化安装设计等多项技术的完美结合，实现了我司太阳能路灯比普通太阳能路灯照度提升2.3倍以上，照度均匀度达0.53，抗阴雨天气时间延长5倍，蓄电池使用寿命达10年以上，光源寿命延长3倍以上，解决了太阳能路灯阴雨天不能长时间持续亮灯，照度不足，整灯各核心部件寿命设计不配套的世界性技术难题，真正做到了太阳能路灯全年100%亮灯。

Unique digital LED drive technology, solar system 80% power-saving control technology, LED lamp beads directly form 4:1 rectangular spot technology (no external lens), battery nano waterproof technology (breathable waterproof), humanized installation design, etc. The perfect combination of technology has realized that the illumination of our solar street lamps is more than 2.3 times higher than that of conventional solar street lamps, the illumination uniformity is 0.53, the anti-rain weather time is extended by 5 times, the battery life is more than 10 years, and the life of the light source is extended by more than 3 times. It solves the worldwide technical problem that the solar street lamp can not continue to light for a long time under the rainy day, the illumination is insufficient, and the life design of the core components of the whole lamp is not matched. The solar street lamp is 100% bright throughout the year.



绿色照明 节能环保 超长寿命 高显色性 温度极低

LED SOLAR STREET LIGHT SERIES
LED太阳能路灯系列



TYNLD-001



TYNLD-002



TYNLD-003



TYNLD-004



TYNLD-005



TYNLD-006



TYNLD-007

LED SOLAR STREET LIGHT SERIES
LED太阳能路灯系列



TYNLD-008



TYNLD-009



TYNLD-010



TYNLD-011



TYNLD-012



TYNLD-013



LED SOLAR STREET LIGHT SERIES
LED太阳能路灯系列



TYNLD-014



TYNLD-015



TYNLD-016



TYNLD-017



TYNLD-018



TYNLD-019

LED SOLAR STREET LIGHT SERIES
LED太阳能路灯系列



TYNLD-020



TYNLD-021



TYNLD-022



TYNLD-023



TYNLD-024



TYNLD-025



TYNLD-026



TYNLD-027



TYNLD-028

LED SOLAR STREET LIGHT SERIES
LED太阳能路灯系列



TYNLD-029



TYNLD-030

LED YARD LAMP SERIES LED庭院灯系列

太阳能庭院灯是一种绿色环保产品，采用高效单晶（多晶）硅太阳能电池供电，免维护密封型蓄电池贮存电能及高效节能光源照明，智能化低能耗控制电路、过充、过放保护，自动光照度控制，性能安全可靠、节能、经济、环保，使用寿命长（太阳能电池可用25年、蓄电池可用5年以上）是未来照明的发展方向 and 照明灯中的一枝秀。蓄电池容量大，太阳光照射一天，可照明整个晚上，且一个月的时间允许20个阴雨天以上正常工作。高强度、耐高温、耐腐蚀的工程塑料灯罩透光率强，美观、坚实、安装维护方便。

Solar Garden Light is a green environmentally friendly product, powered by high-efficiency single crystal (polycrystalline) silicon solar cells, maintenance-free sealed battery storage energy and high-efficiency energy-saving light source lighting, intelligent low-energy control circuit, overcharge, over-discharge protection, Automatic illuminance control, safe and reliable performance, energy saving, economical, environmental protection, long service life (25 years for solar cells, 5 years for batteries) is the development direction of future lighting and a show in lighting. The battery capacity is large, the sun shines for one day, it can illuminate the whole night, and one month allows more than 20 rainy days to work normally. The high-strength, high-temperature resistant and corrosion-resistant engineering plastic lampshade has strong light transmittance, beautiful appearance, solidity, and convenient installation and maintenance.



TYD-001



TYD-002



TYD-003



TYD-004



TYD-005



TYD-006



TYD-007



TYD-008



TYD-009

LED YARD LAMP SERIES LED庭院灯系列

明

明



TYD-010



TYD-011



TYD-018



TYD-019



TYD-012



TYD-013



TYD-014



TYD-015



TYD-016



TYD-017

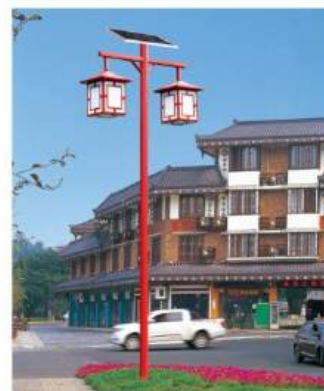

TYD-020



TYD-021



TYD-022



TYD-023



TYD-024



TYD-025

LED LAWN LAMP SERIES LED草坪灯系列

特点:

太阳能草坪灯是以太阳能转化为电能用来提供亮化点缀照明,光源采用高亮度LED,具有光效高、安装便捷、性能可靠、无需挖沟铺线、不消耗常规能源、使用寿命长等特点。主要应用于小区绿化带、工业区绿化带、景观亮化、旅游风景区、公园、庭院、广场绿地等场所的亮化装饰,可按客户需求或图纸加工生产。

Features:

The solar lawn lamp is used to convert the solar energy into electric energy to provide lighting illumination. The light source adopts high-brightness LED, which has high luminous efficiency, convenient installation, reliable performance, no need to dig trenches, no conventional energy consumption, long service life, etc. It is mainly used in the lighting decoration of residential green belts, green belts in industrial areas, landscape lighting, tourist scenic spots, parks, courtyards, square green spaces, etc., which can be processed according to customer needs or drawings.

性能/Performance

太阳能电池组件 Solar panel: 0.5-5W

智能数字控制器 Intelligent Digital Controller:

内含LED驱动模块,比普通控制器延长3-5倍阴雨天

With built-in LED driver module, our solar garden light can work in more than 3-5 times as long as the lamps with common controller in rainy cloudy days.

光源 Light source: LED 2-28 pcs

蓄电池 Battery: 满足5-10阴雨天 Extra energy reserved for 5-10 rainy days.



绿色照明

节能环保

超长寿命

高显色性

温度极低

LED LAWN LAMP SERIES LED草坪灯系列



CPD-001



CPD-002



CPD-003



CPD-004



CPD-005



CPD-006



CPD-007



CPD-008

LED LAWN LAMP SERIES
LED草坪灯系列



CPD-009



CPD-010



CPD-011



CPD-012



CPD-013



CPD-014



CPD-015



CPD-016

WORLD
沃蓝达照明

WORLD
沃蓝达照明

WORLD
沃蓝达照明

WORLD
沃蓝达